



## CJ78L Series Three Terminal Positive Regulators

### 1 Introduction

The CJ78L series is a group of three-terminal positive voltage linear regulators with a fixed voltage output. It can support a maximum input voltage of 30V (or 35V) and provide an output current of 100mA with good heat dissipation. The CJ78L series eliminates the need for peripheral resistors to define voltage outputs, which improves the space efficiency of printed circuit boards (PCBs). In addition, the CJ78L series integrates internal current limiting, short-circuit protection, and thermal shutdown, making it virtually unaffected by overload. Therefore, the CJ78L series is widely used in a variety of scenarios, such as card monitoring, to eliminate noise and distribution issues related to single-point monitoring. When used as an alternative to the Zener diode-resistor combination, the CJ78L series can effectively increase the output impedance and reduce the bias current.

### 2 Available Packages

PART NUMBER	PACKAGE
CJ78L Series	SOT-23-3L
	SOT-89-3L
	TO-92

**Note:** For all available packages, please refer to the part *Orderable Information*.

### 3 Features

- Available Output Voltage:  
5.0V, 6.0V, 8.0V, 9.0V, 12V and 15V
- Maximum Input Voltage:  
30V for  $V_{OUT} < 10V$  products  
35V for  $V_{OUT} > 10V$  products
- Maximum Output Current:  
Exceed 100mA at  $T_J = 25^\circ C$
- Output Tolerances at  $T_J = 25^\circ C$ :  
 $\pm 3\%$  for Conventional Device  
 $\pm 2\%$  can be Customized
- Output Tolerances of  $\pm 5\%$  over the Operating Junction Temperature
- Build-in Current Limit
- Short Circuit Protection
- Thermal Shutdown Protection
- No External Components

### 4 Applications

- TV Board
- Air Conditioner
- Vehicle Mounted Radar
- Charging Device

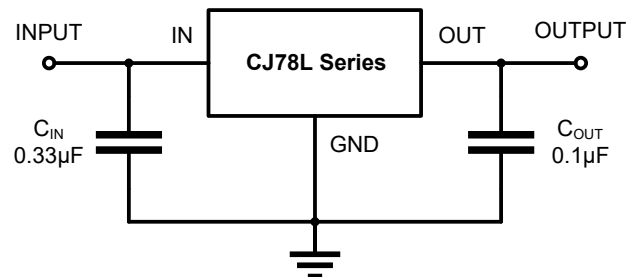

Typical Application Circuit

**5 Orderable Information**

MODEL	DEVICE	PACKAGE	OP T <sub>J</sub>	ECO PLAN	MSL	PACKING OPTION	SORT
<b>Conventional Products (±3% grade)</b>							
CJ78L-5.0	CJ78L05	SOT-23-3L	-40 ~ 125°C	RoHS & Green	Level 3 168 HR	Tape and Reel 3000 Units / Reel	Active
CJ78L-5.0	CJ78L05	SOT-89-3L	-40 ~ 125°C	RoHS & Green	Level 3 168 HR	Tape and Reel 1000 Units / Reel	Active
CJ78L-6.0	CJ78L06	SOT-89-3L	-40 ~ 125°C	RoHS & Green	Level 3 168 HR	Tape and Reel 1000 Units / Reel	Active
CJ78L-8.0	CJ78L08	SOT-89-3L	-40 ~ 125°C	RoHS & Green	Level 3 168 HR	Tape and Reel 1000 Units / Reel	Active
CJ78L-9.0	CJ78L09	SOT-89-3L	-40 ~ 125°C	RoHS & Green	Level 3 168 HR	Tape and Reel 1000 Units / Reel	Active
CJ78L-12	CJ78L12	SOT-89-3L	-40 ~ 125°C	RoHS & Green	Level 3 168 HR	Tape and Reel 1000 Units / Reel	Active
CJ78L-15	CJ78L15	SOT-89-3L	-40 ~ 125°C	RoHS & Green	Level 3 168 HR	Tape and Reel 1000 Units / Reel	Active
CJ78L-5.0	CJ78L05	TO-92	-40 ~ 125°C	RoHS & Green	Level 3 168 HR	Bulk 1000 Units / Bag	Active
CJ78L-6.0	CJ78L06	TO-92	-40 ~ 125°C	RoHS & Green	Level 3 168 HR	Bulk 1000 Units / Bag	Active
CJ78L-8.0	CJ78L08	TO-92	-40 ~ 125°C	RoHS & Green	Level 3 168 HR	Bulk 1000 Units / Bag	Active
CJ78L-9.0	CJ78L09	TO-92	-40 ~ 125°C	RoHS & Green	Level 3 168 HR	Bulk 1000 Units / Bag	Active
CJ78L-12	CJ78L12	TO-92	-40 ~ 125°C	RoHS & Green	Level 3 168 HR	Bulk 1000 Units / Bag	Active
CJ78L-15	CJ78L15	TO-92	-40 ~ 125°C	RoHS & Green	Level 3 168 HR	Bulk 1000 Units / Bag	Active

**5 Orderable Information**

MODEL	DEVICE	PACKAGE	OP T <sub>J</sub>	ECO PLAN	MSL	PACKING OPTION	SORT
<b>Conventional Products (±3% grade, continued)</b>							
CJ78L-5.0	CJ78L05-TA	TO-92	-40 ~ 125°C	RoHS & Green	Level 3 168 HR	Ammo 2000 Units / Box	Active
CJ78L-6.0	CJ78L06-TA	TO-92	-40 ~ 125°C	RoHS & Green	Level 3 168 HR	Ammo 2000 Units / Box	Active
CJ78L-8.0	CJ78L08-TA	TO-92	-40 ~ 125°C	RoHS & Green	Level 3 168 HR	Ammo 2000 Units / Box	Active
CJ78L-9.0	CJ78L09-TA	TO-92	-40 ~ 125°C	RoHS & Green	Level 3 168 HR	Ammo 2000 Units / Box	Active
CJ78L-12	CJ78L12-TA	TO-92	-40 ~ 125°C	RoHS & Green	Level 3 168 HR	Ammo 2000 Units / Box	Active
CJ78L-15	CJ78L15-TA	TO-92	-40 ~ 125°C	RoHS & Green	Level 3 168 HR	Ammo 2000 Units / Box	Active
<b>Customized Products</b>							
CJ78L-x.x	CJ78Lxx	SOT-23-3L	-40 ~ 125°C	RoHS & Green	Level 3 168 HR	Tape and Reel 3000 Units / Reel	Customized
CJ78L-x.x ±2% grade	-	SOT-23-3L	-40 ~ 125°C	RoHS & Green	Level 3 168 HR	Tape and Reel 3000 Units / Reel	Customized
	-	SOT-89-3L	-40 ~ 125°C	RoHS & Green	Level 3 168 HR	Tape and Reel 1000 Units / Reel	Customized
	-	TO-92	-40 ~ 125°C	RoHS & Green	Level 3 168 HR	Bulk 1000 Units / Bag	Customized
	-	TO-92	-40 ~ 125°C	RoHS & Green	Level 3 168 HR	Ammo 2000 Units / Box	Customized
Others	-	-	-	-	-	-	Customized

**Note:**

**ECO PLAN:** For the RoHS and Green certification standards of this product, please refer to the official report provided by JSCJ.

**MSL:** Moisture Sensitivity Level. Determined according to JEDEC industry standard classification.

**SORT:** Specifically defined as follows:

Active: Recommended for new products;

Customized: Products manufactured to meet the specific needs of customers;

Preview: The device has been released and has not been fully mass produced. The sample may or may not be available;

NoRD: It is not recommended to use the device for new design. The device is only produced for the needs of existing customers;

Obsolete: The device has been discontinued.

## 6 Pin Configuration and Marking Information

### 6.1 Pin Configuration and Function

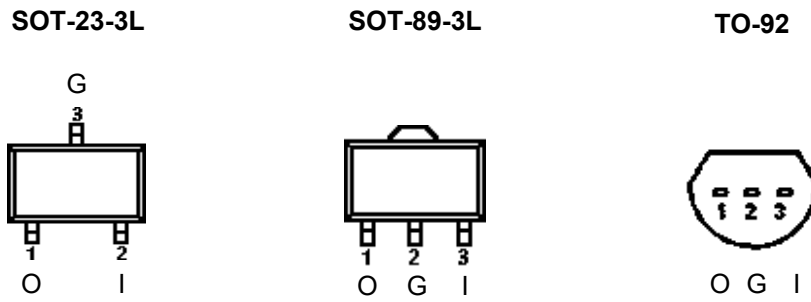
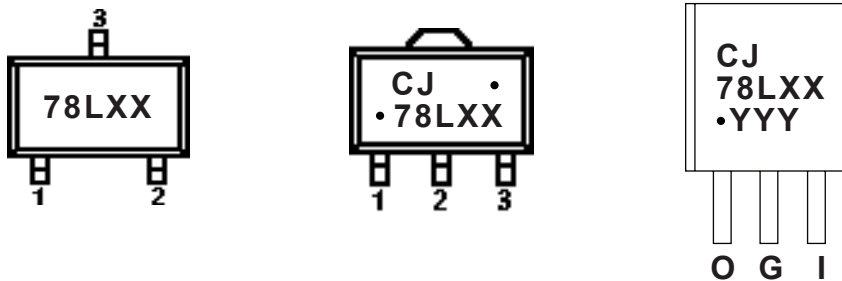

Figure 5-1. Package Top View

PIN NAME	CJ78L Series			I / O	DESCRIPTION
	SOT-23-3L	SOT-89-3L	TO-92		
IN	2	3	3	I	Input to the device.
GND	3	2	2	-	Regulator ground.
OUT	1	1	1	O	Output of the regulator.

### 6.2 Marking Information



"78LXX" or "CJ78LXX": Product number, the "XX" in the "78LXX" or "CJ78LXX" represents the output voltage, for example, if  $V_{OUT} = 5.0V$ , "XX" is "05".

"•" Solid dot: Lower left, represents green molding compound device. Upper right, anchor point.

"YYY": Code.

## 7 Specifications

### 7.1 Absolute Maximum Ratings

(over operating free-air temperature range, unless otherwise specified)

CHARACTERISTIC		SYMBOL	VALUE	UNIT
Maximum input voltage <sup>(2)</sup>	CJ78L05	V <sub>IN MAX</sub>	30	V
	CJ78L06			
	CJ78L08			
	CJ78L09		35	
	CJ78L12			
	CJ78L15			
Maximum power dissipation	SOT-23-3L	P <sub>D Max</sub>	Internally Limited <sup>(3)</sup>	W
	SOT-89-3L			
	TO-92			
Maximum junction temperature		T <sub>J Max</sub>	150	°C
Storage temperature range		T <sub>stg</sub>	- 65 ~ 150	°C
Soldering temperature & time		T <sub>solder</sub>	260°C, 10s	-

(1) Stresses beyond those listed under *Absolute Maximum Ratings* may cause permanent damage to the device. These are stress ratings only, which do not imply functional operation of the device at these or any other conditions beyond those indicated under *Recommended Operating Conditions*. Exposure to absolute-maximum rated conditions for extended periods may affect device reliability.

(2) All voltages are with respect to network ground terminal.

(3) Refer to *Thermal Information* for details.

### 7.2 Recommended Operating Conditions

PARAMETER	SYMBOL	MIN.	NOM.	MAX.	UNIT
Operating junction temperature	T <sub>J</sub>	-40	-	125	°C
Operating ambient temperature	T <sub>A</sub>	-	-	-	°C

### 7.3 ESD Ratings

ESD RATINGS		SYMBOL	VALUE	UNIT
Electrostatic discharge <sup>(4)</sup>	Human body model	V <sub>ESD-HBM</sub>	2000	V
	Machine model	V <sub>ESD-MM</sub>	400	

(4) ESD testing is conducted in accordance with the relevant specifications formulated by the Joint Electronic Equipment Engineering Commission (JEDEC). The human body mode (HBM) electrostatic discharge test is based on the JESD22-114D test standard, using a 100pF capacitor and discharging to each pin of the device through a resistance of 1.5kΩ. The electrostatic discharge test in mechanical mode (MM) is based on the JESD22-115-A test standard and uses a 200pF capacitor to discharge directly to each pin of the device.

## 7 Specifications

### 7.4 Thermal Information

THERMAL METRIC <sup>(5)</sup>	SYMBOL	CJ78L Series			UNIT
		SOT-23-3L	SOT-89-3L	TO-92	
Junction-to-ambient thermal resistance	$R_{\theta JA}$	257.1	116.5	178.2	°C/W
Junction-to-case thermal resistance	$R_{\theta JC}$	63.8	29.1	42.2	°C/W
Reference maximum power dissipation for continuous operation	$P_{D Ref}$	0.38	0.83	0.56	W

(5) Thermal metric is measured in still air with  $T_A = 25^\circ\text{C}$  and installed on a 1 in<sup>2</sup> FR-4 board covered with 2 ounces of copper.

### 7.5 Electrical Characteristics

**CJ78L05 ( $V_{IN} = 10\text{V}$ ,  $I_{OUT} = 40\text{mA}$ ,  $C_{IN} = 0.33\mu\text{F}$ ,  $C_{OUT} = 0.1\mu\text{F}$ ,  $T_J = 25^\circ\text{C}$ , unless otherwise specified)**

CHARACTERISTIC	SYMBOL	TEST CONDITIONS <sup>(6)</sup>	MIN.	TYP.	MAX.	UNIT	
Input voltage	$V_{IN}$	-	-	-	30	V	
Output voltage	$V_{OUT}$	$T_J = 25^\circ\text{C}$	$\pm 3\%$ grade <sup>(7)</sup>	4.85	5.00	5.15	V
			$\pm 2\%$ grade <sup>(7)</sup>	4.90		5.10	
		$V_{IN} = 7$ to $20\text{V}$ , $I_{OUT} = 1$ to $40\text{mA}$	4.75	5.25			
		$I_{OUT} = 1$ to $70\text{mA}$	4.75	5.25			
Output current	$I_{OUT}$	-	100	-	-	mA	
Quiescent current	$I_Q$	$I_{OUT} = 0\text{mA}$	-	3.8	6.0	mA	
Quiescent current change	$\Delta I_Q$	$V_{IN} = 8$ to $20\text{V}$	-	-	1.5	mA	
		$I_{OUT} = 1$ to $40\text{mA}$	-	-	0.1	mA	
Dropout voltage	$V_{DO}^{(8)}$	-	-	1.7	-	V	
Line regulation	$\Delta V_{LINE}$	$V_{IN} = 7$ to $20\text{V}$	-	32	150	mV	
		$V_{IN} = 8$ to $20\text{V}$	-	26	100		
Load regulation	$\Delta V_{LOAD}$	$I_{OUT} = 1$ to $100\text{mA}$	-	15	60	mV	
		$I_{OUT} = 1$ to $40\text{mA}$	-	8	30		
Output noise voltage	$V_N$	$f = 10$ to $100\text{kHz}$	-	42	-	$\mu\text{V}/V_{OUT}$	
Ripple rejection	RR	$V_{IN} = 8$ to $20\text{V}$ , $f = 120\text{Hz}$	41	49	-	dB	

7 Specifications

7.5 Electrical Characteristics (continued)

CJ78L06 ( $V_{IN} = 11V$ ,  $I_{OUT} = 40mA$ ,  $C_{IN} = 0.33\mu F$ ,  $C_{OUT} = 0.1\mu F$ ,  $T_J = 25^\circ C$ , unless otherwise specified)

CHARACTERISTIC	SYMBOL	TEST CONDITIONS <sup>(6)</sup>		MIN.	TYP.	MAX.	UNIT
Input voltage	$V_{IN}$	-		-	-	30	V
Output voltage	$V_{OUT}$	$T_J = 25^\circ C$	$\pm 3\%$ grade <sup>(7)</sup>	5.82	6.00	6.18	V
			$\pm 2\%$ grade <sup>(7)</sup>	5.88		6.12	
		$V_{IN} = 8$ to $20V$ , $I_{OUT} = 1$ to $40mA$		5.70		6.30	
		$I_{OUT} = 1$ to $70mA$		5.70		6.30	
Output current	$I_{OUT}$	-		100	-	-	mA
Quiescent current	$I_Q$	$I_{OUT} = 0mA$		-	3.9	6.0	mA
Quiescent current change	$\Delta I_Q$	$V_{IN} = 9$ to $20V$		-	-	1.5	mA
		$I_{OUT} = 1$ to $40mA$		-	-	0.1	mA
Dropout voltage	$V_{DO}^{(8)}$	-		-	1.7	-	V
Line regulation	$\Delta V_{LINE}$	$V_{IN} = 8$ to $20V$		-	35	175	mV
		$V_{IN} = 9$ to $20V$		-	29	125	
Load regulation	$\Delta V_{LOAD}$	$I_{OUT} = 1$ to $100mA$		-	16	80	mV
		$I_{OUT} = 1$ to $40mA$ ,		-	9	40	
Output noise voltage	$V_N$	$f = 10$ to $100kHz$		-	46	-	$\mu V/V_{OUT}$
Ripple rejection	RR	$V_{IN} = 9$ to $19V$ , $f = 120Hz$		40	48	-	dB

CJ78L08 ( $V_{IN} = 14V$ ,  $I_{OUT} = 40mA$ ,  $C_{IN} = 0.33\mu F$ ,  $C_{OUT} = 0.1\mu F$ ,  $T_J = 25^\circ C$ , unless otherwise specified)

CHARACTERISTIC	SYMBOL	TEST CONDITIONS <sup>(6)</sup>		MIN.	TYP.	MAX.	UNIT
Input voltage	$V_{IN}$	-		-	-	30	V
Output voltage	$V_{OUT}$	$T_J = 25^\circ C$	$\pm 3\%$ grade <sup>(7)</sup>	7.76	8.00	8.24	V
			$\pm 2\%$ grade <sup>(7)</sup>	7.84		8.15	
		$V_{IN} = 10.5$ to $23V$ , $I_{OUT} = 1$ to $40mA$		7.60		8.40	
		$I_{OUT} = 1$ to $70mA$		7.76		8.40	
Output current	$I_{OUT}$	-		100	-	-	mA
Quiescent current	$I_Q$	$I_{OUT} = 0mA$		-	4.0	6.0	mA
Quiescent current change	$\Delta I_Q$	$V_{IN} = 11$ to $23V$		-	-	1.5	mA
		$I_{OUT} = 1$ to $40mA$		-	-	0.1	mA
Dropout voltage	$V_{DO}^{(8)}$	-		-	1.7	-	V
Line regulation	$\Delta V_{LINE}$	$V_{IN} = 10.5$ to $23V$		-	42	175	mV
		$V_{IN} = 11$ to $23V$		-	36	125	
Load regulation	$\Delta V_{LOAD}$	$I_{OUT} = 1$ to $100mA$		-	18	80	mV
		$I_{OUT} = 1$ to $40mA$		-	10	40	
Output noise voltage	$V_N$	$f = 10$ to $100kHz$		-	54	-	$\mu V/V_{OUT}$
Ripple rejection	RR	$V_{IN} = 13$ to $23V$ , $f = 120Hz$		37	46	-	dB

## 7 Specifications

### 7.5 Electrical Characteristics (continued)

**CJ78L09 ( $V_{IN} = 16V$ ,  $I_{OUT} = 40mA$ ,  $C_{IN} = 0.33\mu F$ ,  $C_{OUT} = 0.1\mu F$ ,  $T_J = 25^\circ C$ , unless otherwise specified)**

CHARACTERISTIC	SYMBOL	TEST CONDITIONS <sup>(6)</sup>		MIN.	TYP.	MAX.	UNIT
Input voltage	$V_{IN}$	-		-	-	30	V
Output voltage	$V_{OUT}$	$T_J = 25^\circ C$	$\pm 3\%$ grade <sup>(7)</sup>	8.73	9.00	9.27	V
			$\pm 2\%$ grade <sup>(7)</sup>	8.82		9.18	
		$V_{IN} = 12$ to $24V$ , $I_{OUT} = 1$ to $40mA$		8.55		9.45	
		$I_{OUT} = 1$ to $70mA$		8.55		9.45	
Output current	$I_{OUT}$	-		100	-	-	mA
Quiescent current	$I_Q$	$I_{OUT} = 0mA$		-	4.1	6.0	mA
Quiescent current change	$\Delta I_Q$	$V_{IN} = 13$ to $24V$		-	-	1.5	mA
		$I_{OUT} = 1$ to $40mA$		-	-	0.1	mA
Dropout voltage	$V_{DO}^{(8)}$	-		-	1.7	-	V
Line regulation	$\Delta V_{LINE}$	$V_{IN} = 12$ to $24V$		-	45	175	mV
		$V_{IN} = 13$ to $24V$		-	40	125	
Load regulation	$\Delta V_{LOAD}$	$I_{OUT} = 1$ to $100mA$		-	19	90	mV
		$I_{OUT} = 1$ to $40mA$		-	11	40	
Output noise voltage	$V_N$	$f = 10$ to $100kHz$		-	58	-	$\mu V/V_{OUT}$
Ripple rejection	RR	$V_{IN} = 15$ to $25V$ , $f = 120Hz$		37	45	-	dB

**CJ78L12 ( $V_{IN} = 19V$ ,  $I_{OUT} = 40mA$ ,  $C_{IN} = 0.33\mu F$ ,  $C_{OUT} = 0.1\mu F$ ,  $T_J = 25^\circ C$ , unless otherwise specified)**

CHARACTERISTIC	SYMBOL	TEST CONDITIONS <sup>(6)</sup>		MIN.	TYP.	MAX.	UNIT
Input voltage	$V_{IN}$	-		-	-	35	V
Output voltage	$V_{OUT}$	$T_J = 25^\circ C$	$\pm 3\%$ grade <sup>(7)</sup>	11.64	12.00	12.36	V
			$\pm 2\%$ grade <sup>(7)</sup>	11.76		12.24	
		$V_{IN} = 14$ to $27V$ , $I_{OUT} = 1$ to $40mA$		11.40		12.60	
		$I_{OUT} = 1$ to $70mA$		11.40		12.60	
Output current	$I_{OUT}$	-		100	-	-	mA
Quiescent current	$I_Q$	$I_{OUT} = 0mA$		-	4.3	6.5	mA
Quiescent current change	$\Delta I_Q$	$V_{IN} = 14.5$ to $27V$		-	-	1.5	mA
		$I_{OUT} = 1$ to $40mA$		-	-	0.1	mA
Dropout voltage	$V_{DO}^{(8)}$	-		-	1.7	-	V
Line regulation	$\Delta V_{LINE}$	$V_{IN} = 14.5$ to $27V$		-	55	250	mV
		$V_{IN} = 16$ to $27V$		-	49	200	
Load regulation	$\Delta V_{LOAD}$	$I_{OUT} = 1$ to $100mA$		-	22	100	mV
		$I_{OUT} = 1$ to $40mA$		-	13	50	
Output noise voltage	$V_N$	$f = 10$ to $100kHz$		-	70	-	$\mu V/V_{OUT}$
Ripple rejection	RR	$V_{IN} = 15$ to $25V$ , $f = 120Hz$		37	42	-	dB



## 7 Specifications

### 7.5 Electrical Characteristics (continued)

**CJ78L15 ( $V_{IN} = 23V$ ,  $I_{OUT} = 40mA$ ,  $C_{IN} = 0.33\mu F$ ,  $C_{OUT} = 0.1\mu F$ ,  $T_J = 25^\circ C$ , unless otherwise specified)**

CHARACTERISTIC	SYMBOL	TEST CONDITIONS <sup>(6)</sup>	MIN.	TYP.	MAX.	UNIT	
Input voltage	$V_{IN}$	-	-	-	35	V	
Output voltage	$V_{OUT}$	$T_J = 25^\circ C$	$\pm 3\%$ grade <sup>(7)</sup>	14.55	15.00	15.45	V
			$\pm 2\%$ grade <sup>(7)</sup>	14.70		15.30	
		$V_{IN} = 17.5$ to $30V$ , $I_{OUT} = 1$ to $40mA$		14.25		15.75	
		$I_{OUT} = 1$ to $70mA$		14.25		15.75	
Output current	$I_{OUT}$	-	100	-	-	mA	
Quiescent current	$I_Q$	$I_{OUT} = 0mA$	-	4.6	6.5	mA	
Quiescent current change	$\Delta I_Q$	$V_{IN} = 19$ to $30V$	-	-	1.5	mA	
		$I_{OUT} = 1$ to $40mA$	-	-	0.1	mA	
Dropout voltage	$V_{DO}$ <sup>(8)</sup>	-	-	1.7	-	V	
Line regulation	$\Delta V_{LINE}$	$V_{IN} = 17.5$ to $30V$	-	65	300	mV	
		$V_{IN} = 19$ to $30V$	-	58	250		
Load regulation	$\Delta V_{LOAD}$	$I_{OUT} = 1$ to $100mA$	-	25	150	mV	
		$I_{OUT} = 1$ to $40mA$	-	15	75		
Output noise voltage	$V_N$	$f = 10$ to $100kHz$	-	82	-	$\mu V/V_{OUT}$	
Ripple rejection	RR	$V_{IN} = 18.5$ to $28.5V$ , $f = 120Hz$	34	39	-	dB	

(6) Pulse test technology is used to make  $T_J$  as close to  $T_A$  as possible. Thermal effects must be considered separately.

(7) Output voltage tolerances of  $\pm 3\%$  for conventional device,  $\pm 2\%$  can be customized.

(8) Test the difference of output voltage and input voltage when input voltage is decreased gradually till output voltage equals to 95% of  $V_{OUT}$ .

## 7 Specifications

### 7.6 Typical Characteristics

CJ78L05 ( $V_{OUT} = 5.0V$ ,  $T_J = 25^\circ C$ , unless otherwise specified)

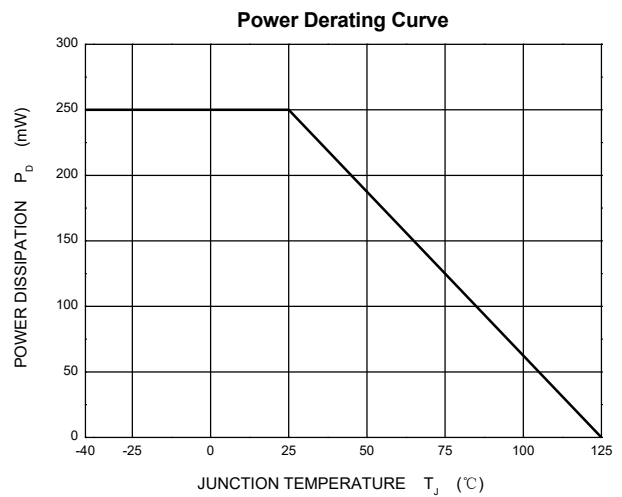
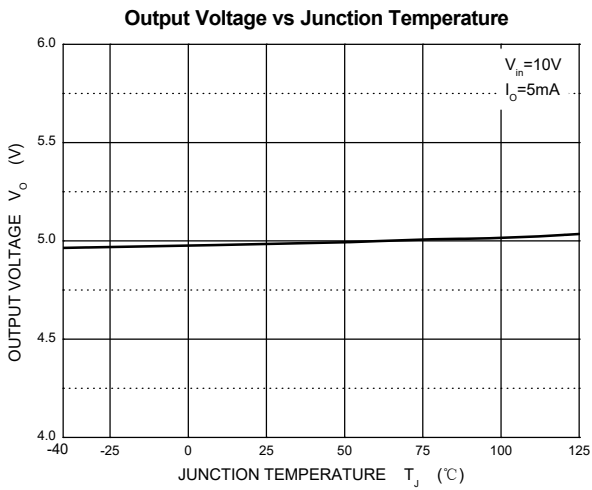
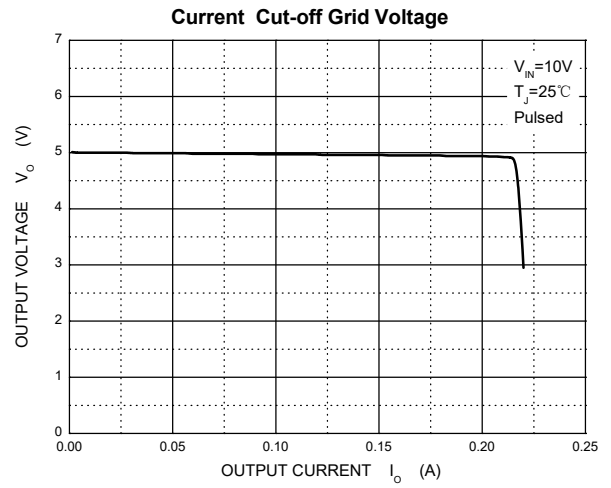
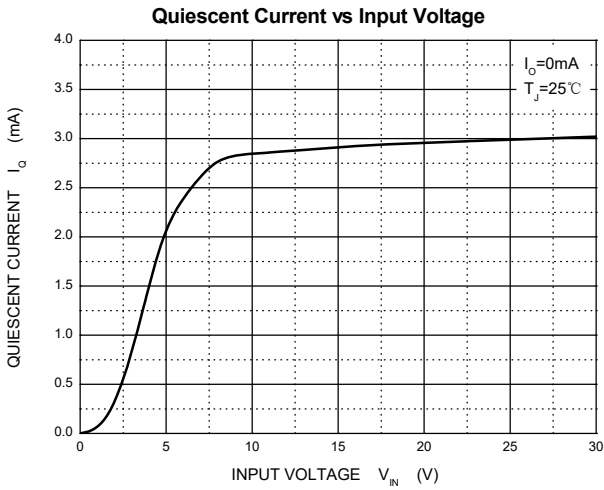
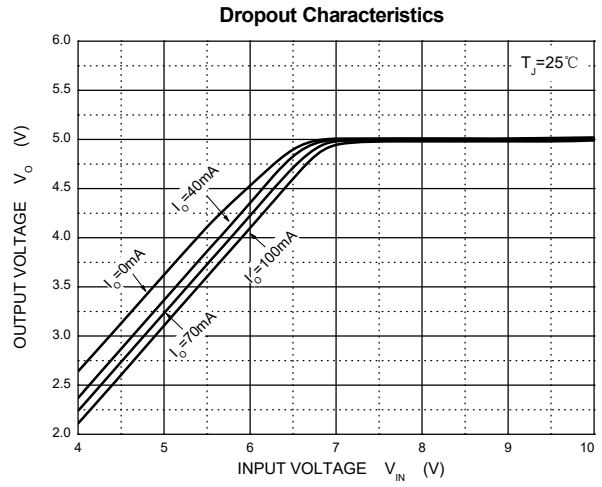
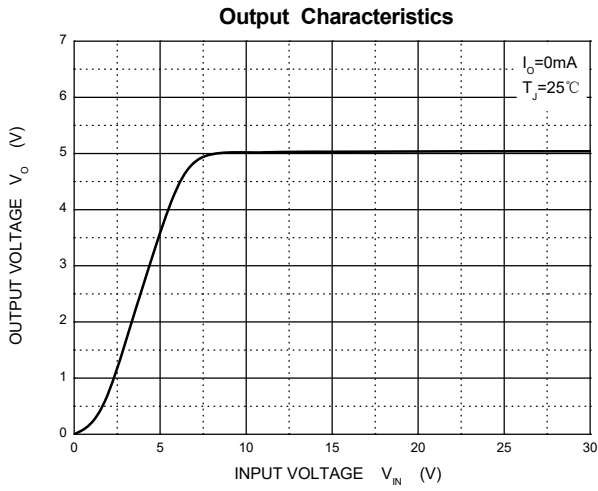

## 7 Specifications

### 7.6 Typical Characteristics (continued)

CJ78L06 ( $V_{OUT} = 6.0V$ ,  $T_J = 25^\circ C$ , unless otherwise specified)

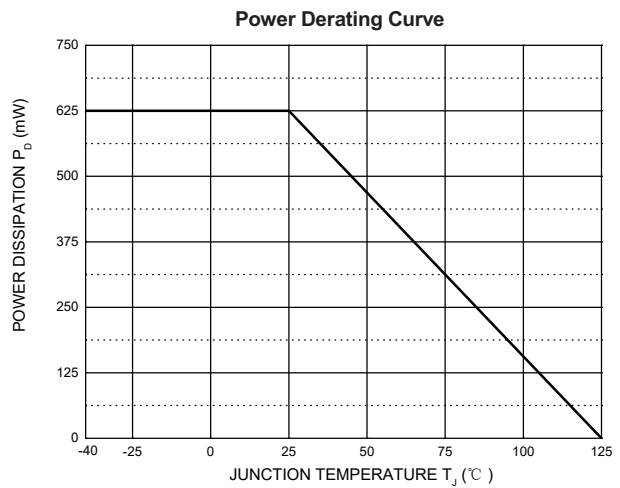
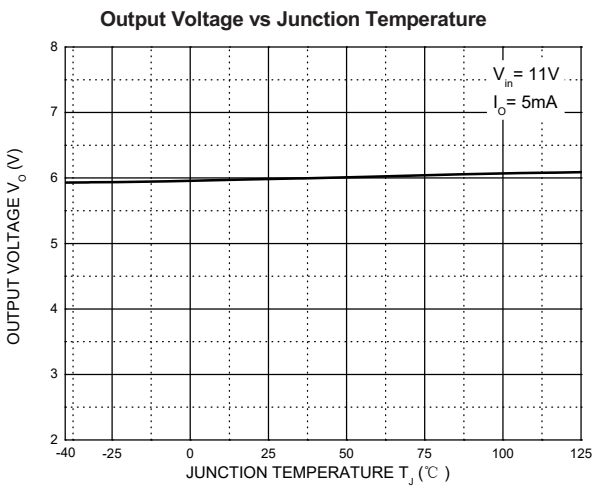
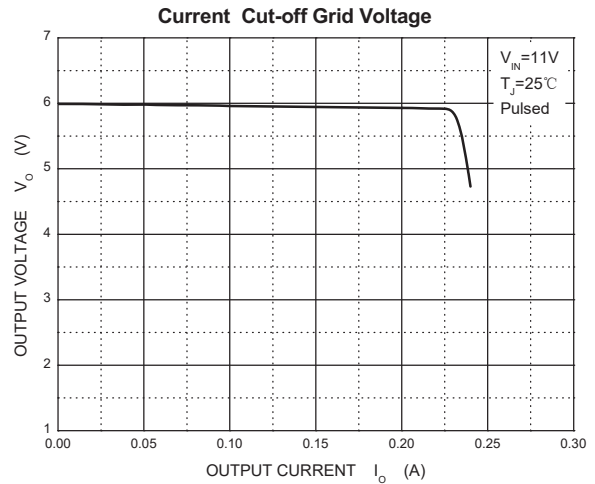
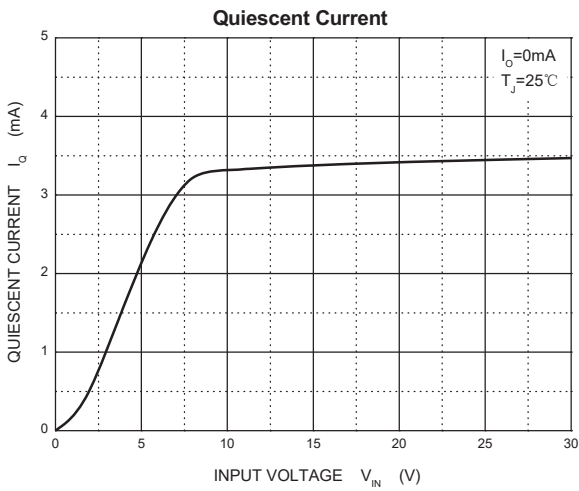
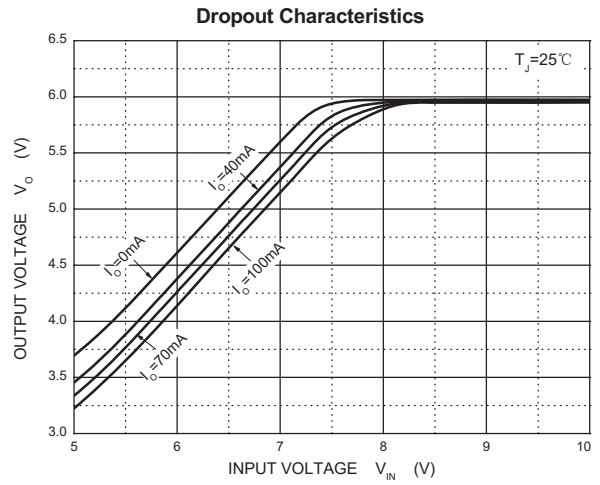
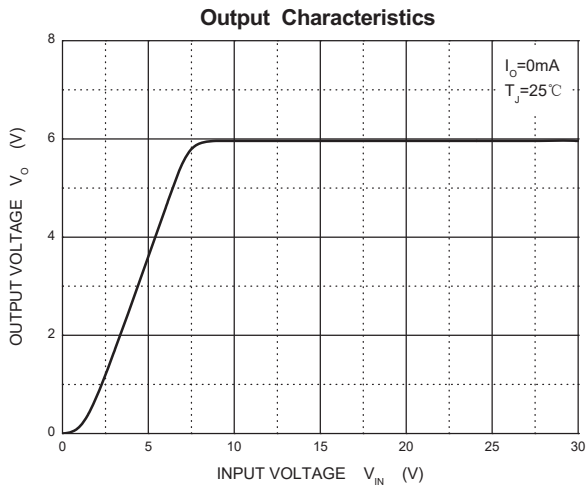

## 7 Specifications

### 7.6 Typical Characteristics (continued)

CJ78L08 ( $V_{OUT} = 8.0V$ ,  $T_J = 25^\circ C$ , unless otherwise specified)

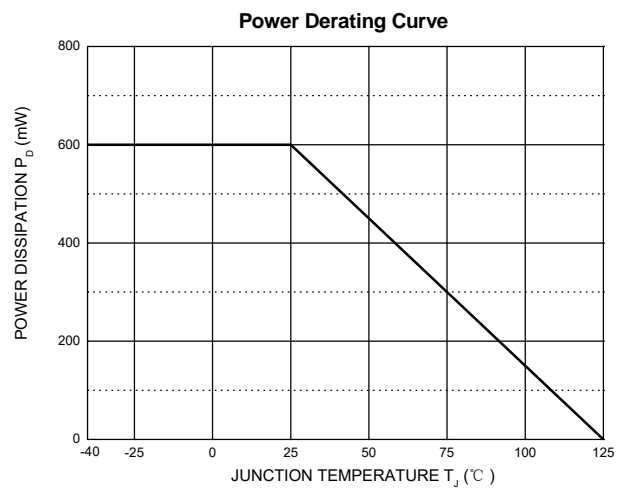
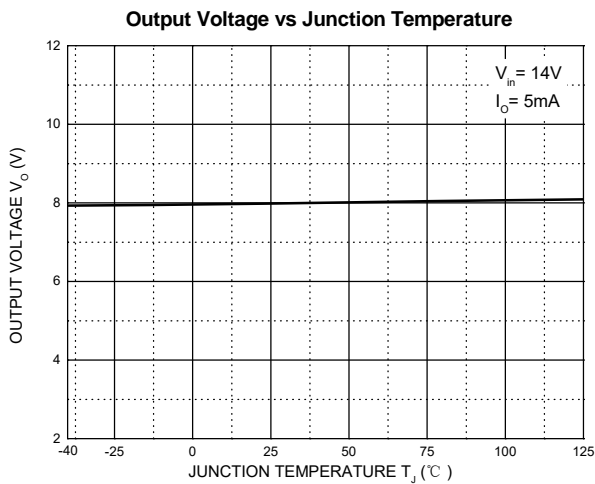
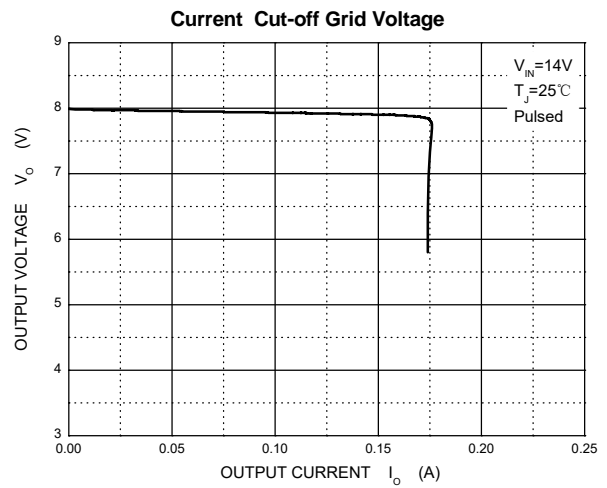
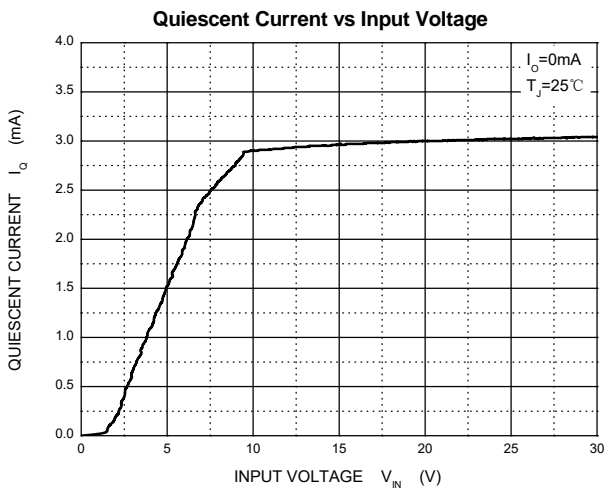
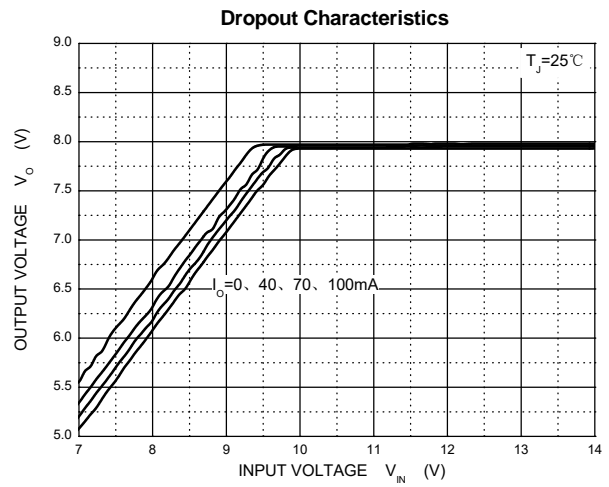
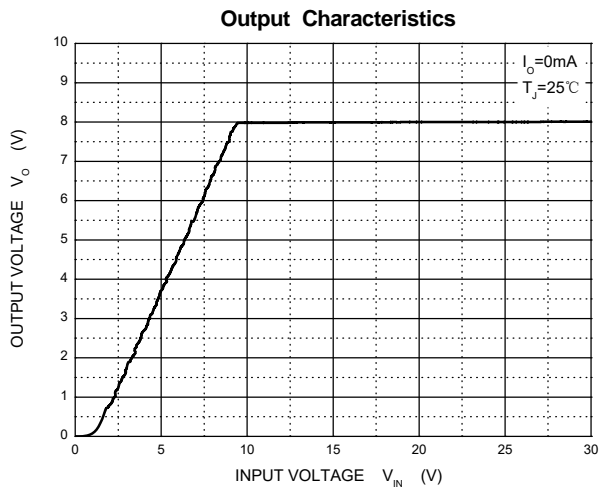

## 7 Specifications

### 7.6 Typical Characteristics (continued)

CJ78L09 ( $V_{OUT} = 9.0V$ ,  $T_J = 25^\circ C$ , unless otherwise specified)

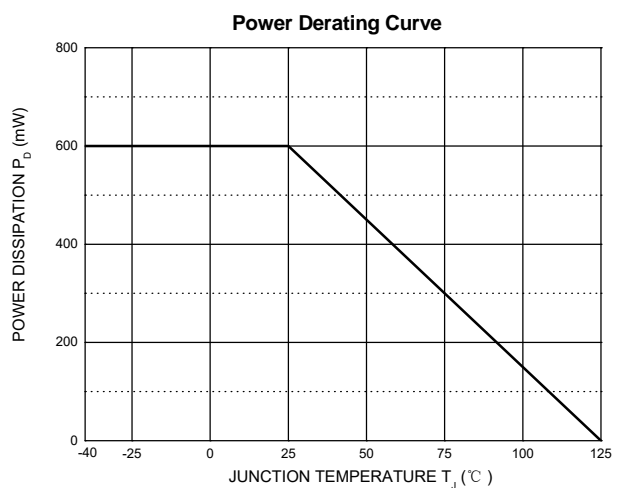
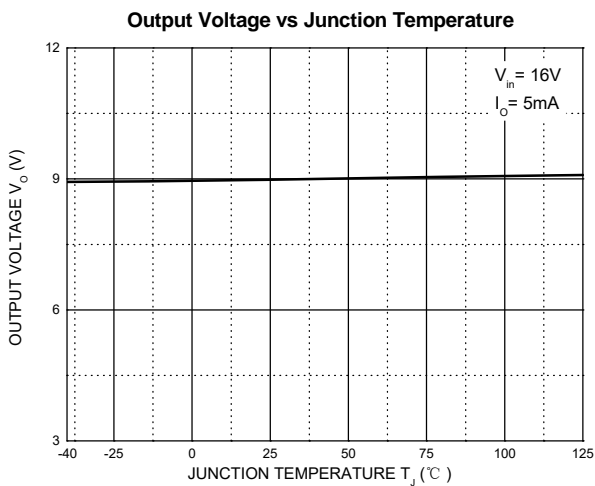
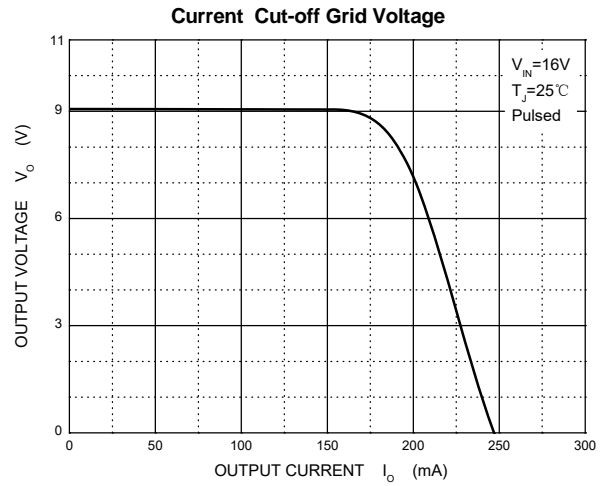
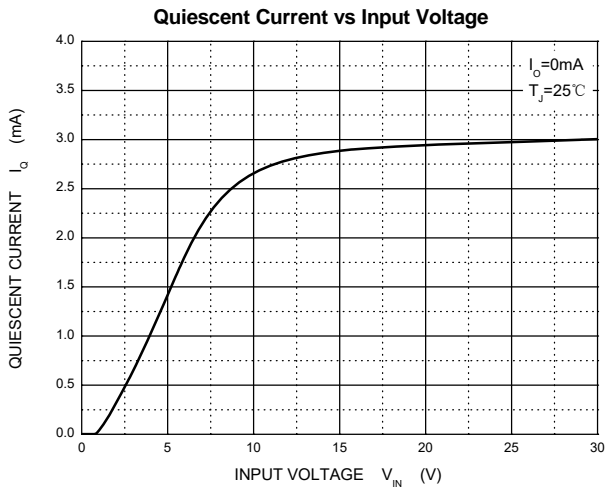
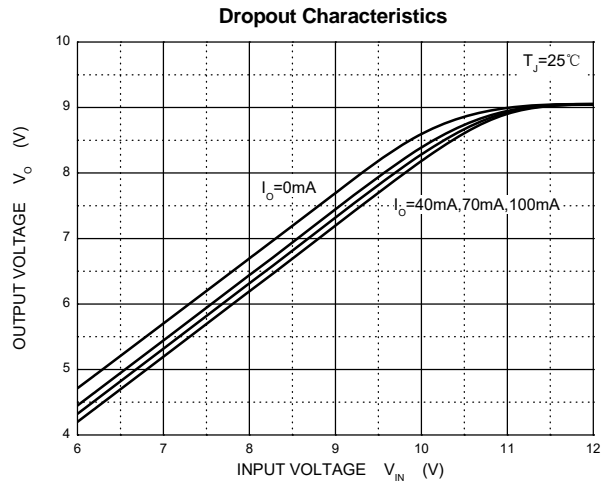
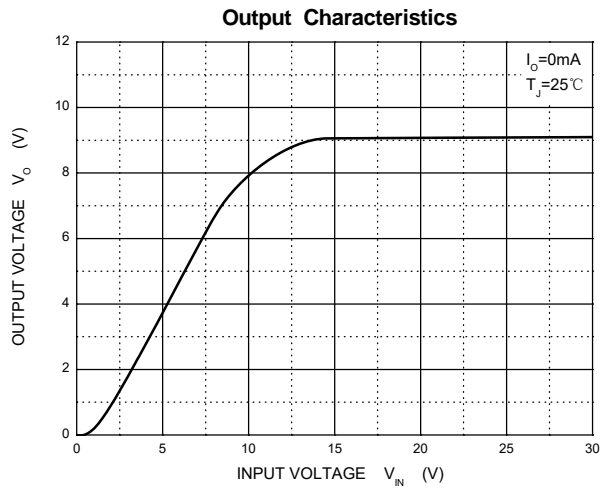

## 7 Specifications

### 7.6 Typical Characteristics (continued)

CJ78L12 ( $V_{OUT} = 12V$ ,  $T_J = 25^\circ C$ , unless otherwise specified)

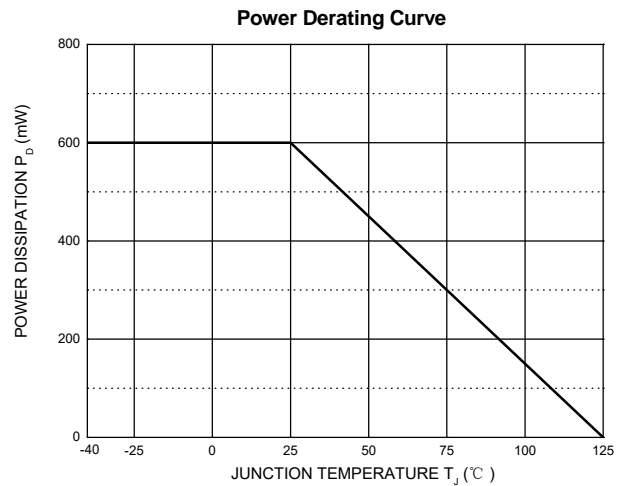
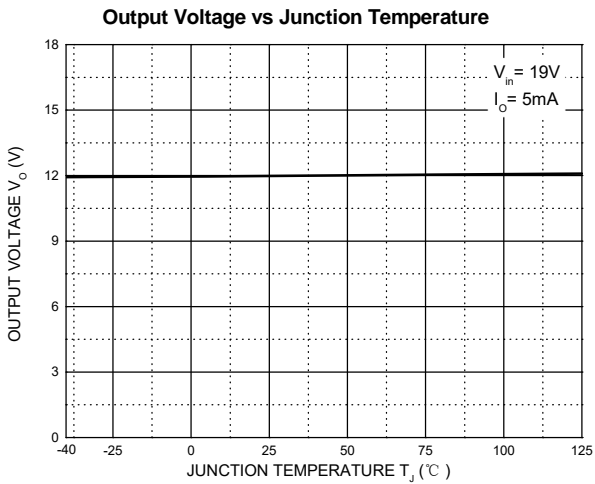
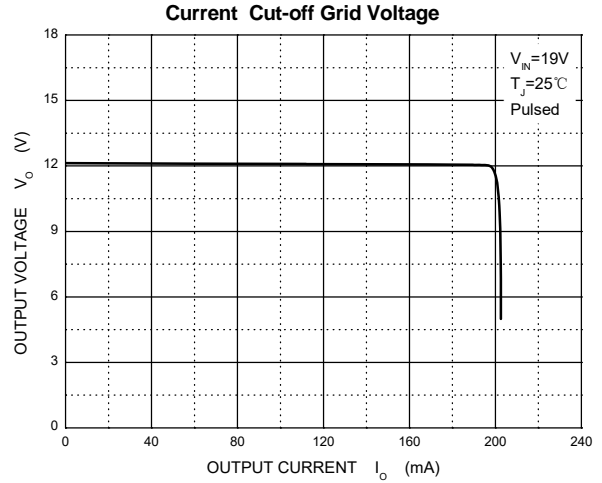
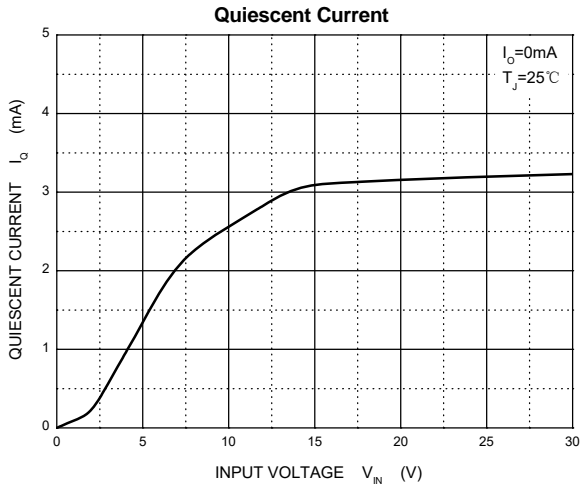
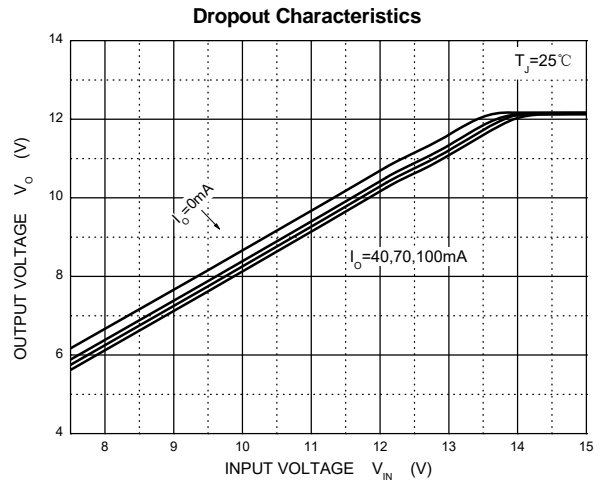
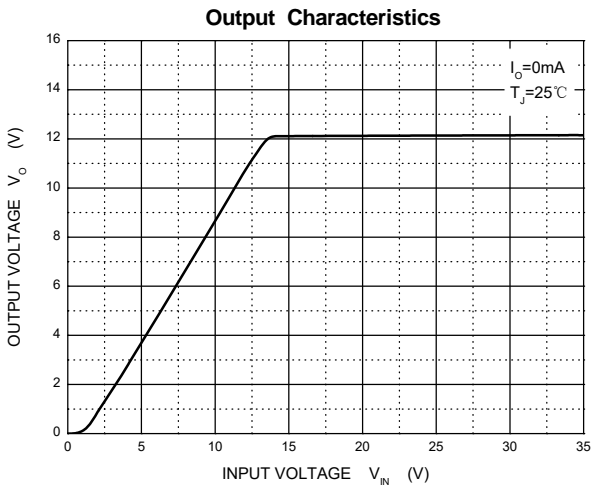

7 Specifications

7.6 Typical Characteristics (continued)

CJ78L15 ( $V_{OUT} = 15V$ ,  $T_J = 25^\circ C$ , unless otherwise specified)

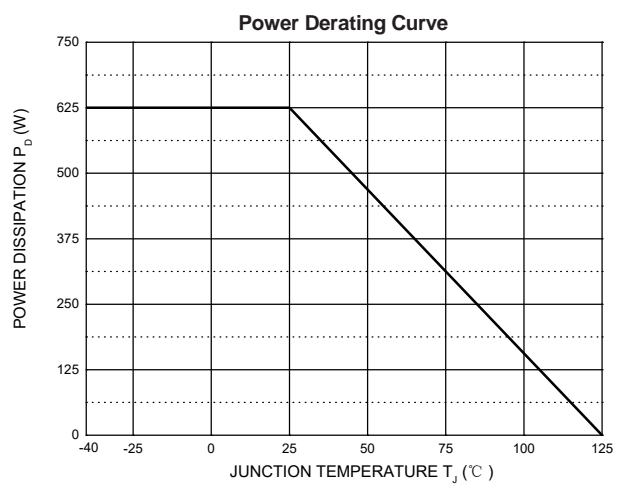
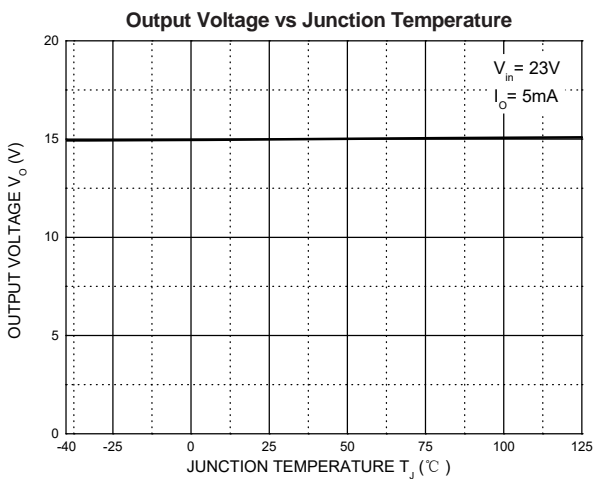
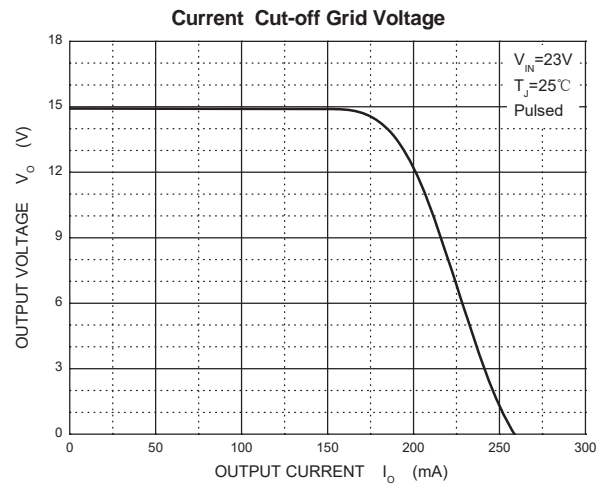
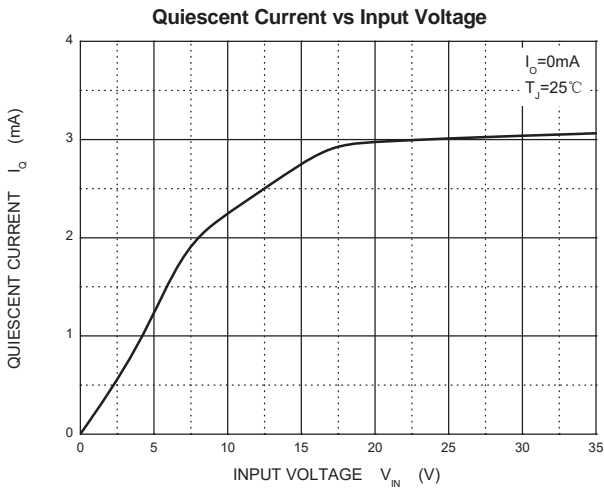
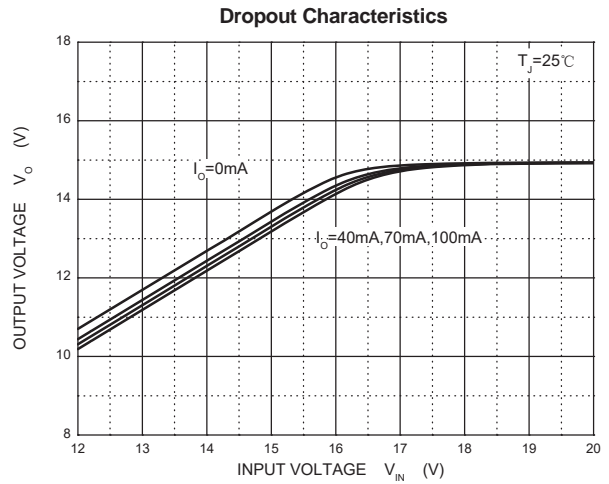
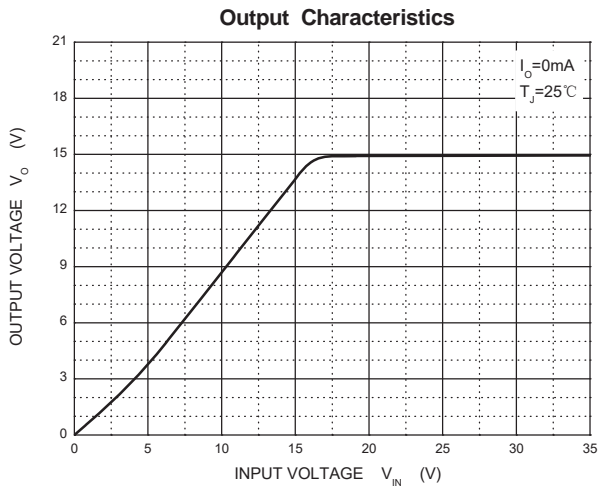

## 8 Detailed Description

### 8.1 Description

The CJ78L series integrates current limit, short circuit protection and thermal shutdown to reduce the possibility of circuit overload. The CJ78L series has a fixed output voltage version, which allows the fixed output CJ78L series to be used as an output circuit with adjustable voltage by setting two peripheral resistors.

### 8.2 Representative Schematic Diagram

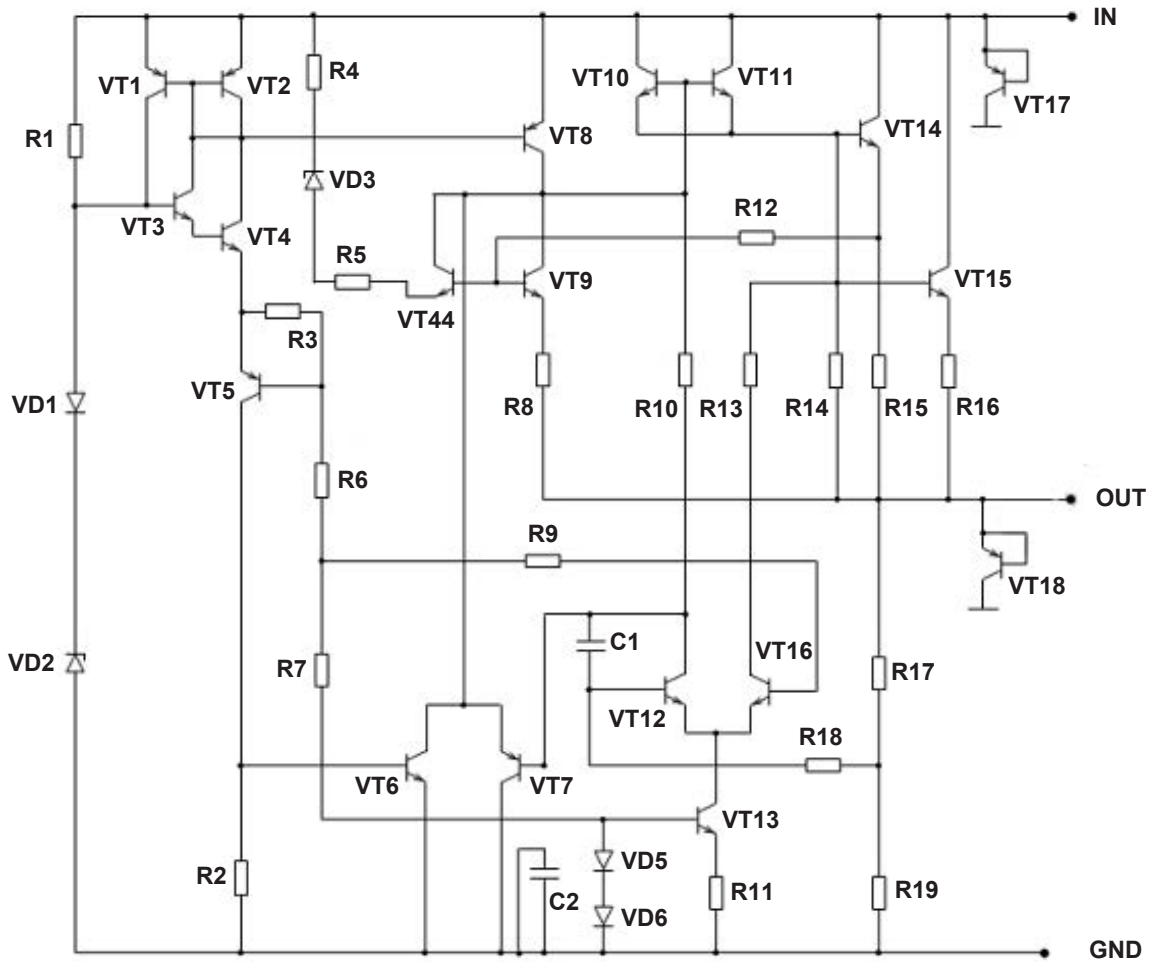



## 8 Detailed Description

### 8.3 Feature Description

#### Input Voltage

When the input voltage is lower than the rated range of the data sheet, the device will lose the regulation function of stabilizing the output voltage, that is, it is unable to maintain the output voltage within the rated range. At this time, compared with normal operation, the quiescent current of the device may exceed the rated range, and the transient response performance of the device may be seriously degraded.

When the input voltage is higher than the rated range of the data sheet, the device may cause irreversible damage or failure due to exceeding the maximum rated range of electrical stress.

#### Output Current

When the circuit design is appropriate, the CJ78L series can reach the maximum load capacity of at least 100mA. According to the heat dissipation power consumption of the package and the effective connection thermal resistance with the environment, selecting the appropriate package for the circuit design can make the device emit more heat energy.

#### Thermal Shutdown

The CJ78L series has thermal shutdown protection mechanism. When the junction temperature exceeds the rated temperature range for normal operation in the data sheet, the device will enter the thermal shutdown state. At this time, the output voltage of the device will be reduced to prevent catastrophic damage to the chip due to accidental heat. When the junction temperature decreases and no longer remains too high, the device will release the thermal shutdown and output normally.

To ensure reliable operation, please limit the junction temperature to the specified range of *Recommended Operating Conditions* in the data sheet. Applications that exceed the recommended temperature range may cause the equipment to exceed its operating specifications. Although the internal protection circuitry of the device is designed to protect against thermal overall conditions, this circuitry is not intended to replace proper heat sinking. Continuously running the device into thermal shutdown or above the maximum recommended junction temperature reduces long-term reliability.

#### Current Limit & Short Circuit Protection

The CJ78L series has current limiting and short circuit protection mechanism. When the output current of the device is too high, the output of the device will be shut down. When the output of the device is short circuited to ground, the output of the device will also be shut down and the output current will be maintained within a certain range.

## 9 Application and Implementation

### 9.1 Risk Alert and Precautions

The CJ78L series is designed for thermal protection, output short circuit protection and built-in current limit. However, like any IC regulator, precautions are necessary to reduce the possibility of accidental damage to the regulator. The following describes the possible causes of unit damage or failure:

#### Electrostatic Discharge (ESD) and Instantaneous Electrical Surge

Electrostatic discharge (ESD) is a common near-field hazard source. It comes from many sources, such as human body, mechanical equipment and electronic components themselves. ESD can cause phenomena such as high voltage and instantaneous high current in a very short time, resulting in damage or failure of the device due to electric shock.

In some applications, a short duration but high energy spike may occur in the circuit, including peak voltage and surge current. They may cause unstable operation of the regulator, accelerated aging and potential hazards, and even damage or malfunction of the regulator. These peaks are usually more likely to occur in hot-plug, switch inductance, heavy-load, and other types of circuits.

#### Precautions for ESD and Electrical Surge

In the practical application of the circuit, adopting the following suggestions can reduce the possibility of device failure due to the above reasons to a certain extent.

Using TVS:

Place a TVS between the IN and GND of the voltage regulator to absorb the peak voltage that may be generated due to ESD or other reasons. As shown in Figure 9-4;

Using Input Resistor:

Place a resistor with appropriate resistance in series before the IN of the voltage regulator, which can help the voltage regulator share part of the energy in case of surge. The resistance value of the resistance should not be too large. The specific resistance value depends on the application of the circuit. Generally, the resistance value of this resistance does not exceed 20Ω. As shown in Figure 9-5;

Using Electrolytic Capacitor:

For the application circuit using the low ESR multilayer ceramic capacitor (MLCC) type input capacitor, the LC resonant voltage spike caused by hot plugging or power transmission line inductance can be suppressed by using RC suppression circuit for parallel connection of the input capacitor. A very simple method is to parallel a suitable electrolytic capacitor to the input capacitor. As shown in Figure 9-6. For most 100μF/25V electrolytic capacitor has an ESR of about 0.2Ω at 100kHz. This can completely suppress the overshoot phenomenon of the input and minimize the possibility of IC damage due to input voltage spikes.

Figure 9-1 and Figure 9-2 show the impact of not using electrolytic capacitor [Test circuit is shown in Figure 9-3 ] and using 100μF/25V electrolytic capacitor parallel to the input capacitor [Test circuit is shown in Figure 9-6 ] on suppressing surge voltage. As shown in Figure 9-1., when the input is powered on from 0 to 10V, a peak voltage of up to 23V (shown in the RED part) is generated in front of the input terminal of the device. When the electrolytic capacitor is used, as shown in Figure 9-2., the peak voltage generated by power on is effectively suppressed (shown in the GREEN part).

## 9 Application and Implementation

### 9.1 Risk Alert and Precautions (continued)

Test Condition: CJ78L05,  $C_{IN} = 10\mu\text{F}$  (MLCC),  $C_{OUT} = 100\mu\text{F}$ ,  $V_{IN} = 0 \sim 10\text{V}$ ,  $I_{OUT} = 100\text{mA}$ , CH<sub>1</sub>:  $V_{IN}$ , CH<sub>2</sub>:  $V_{OUT}$ .

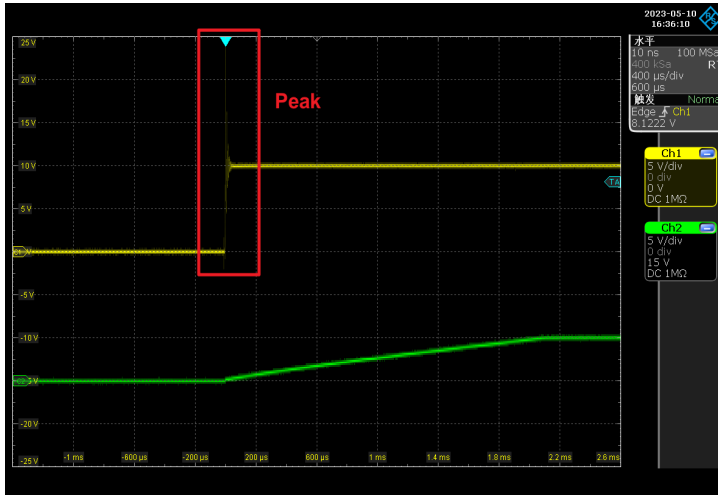

Figure 9-1. Test with the conventional circuit

[Test Circuit is shown in Figure 9-3]

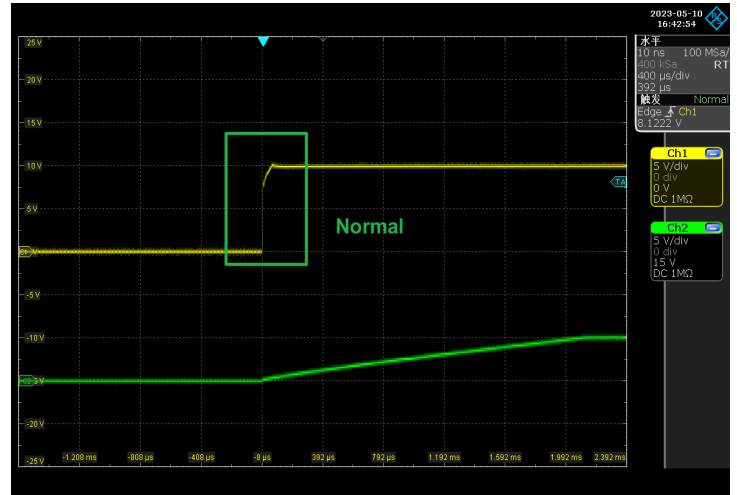

Figure 9-2. Test with the circuit that a  $100\mu\text{F}/25\text{V}$  electrolytic capacitor parallel to the  $C_{IN}$   
[Test Circuit is shown in Figure 9-6]

For the CJ78L05, CJ78L06, CJ78L08, CJ78L09, it is recommended that the input voltage should not exceed 16V and the peak voltage should not exceed 30V. For the CJ78L12, CJ78L15, it is recommended that the input voltage should not exceed 18V and the peak voltage should not exceed 35V. **When the input voltage of the operating circuit may not meet the application conditions described above, it is recommended to adopt the circuit layout shown in Figure 9-5 in the circuit design.**

#### Large Output Capacitance

The CJ78L series can obtain better transient response with the help of output capacitance. However, if the output capacitor is relatively large, the surge current generated by the charging of the output capacitor will also be large at the moment of power on of the regulator, and the large surge current passing through the regulator may damage the internal circuit. When the output capacitance is large, adopting the circuit design shown in Figure 9-2 will reduce the possibility of damage to the device due to large surge current to a certain extent. It is recommended that the selection of output capacitor should not exceed  $20\mu\text{F}$ . **If the selection of output capacitor exceeds  $20\mu\text{F}$ , it is recommended to adopt the circuit design in Figure 9-5 to reduce the possibility of accidental failure of the device due to large surge current during power on.**

### 9.2 Typical Application Circuits

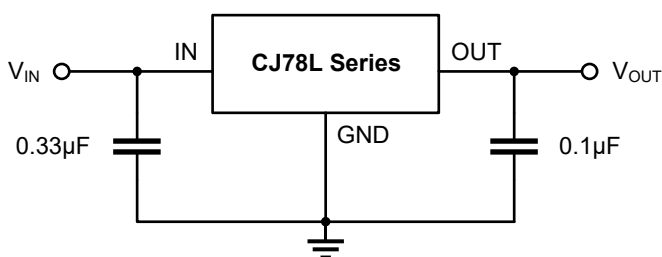

Figure 9-3. Conventional Circuit

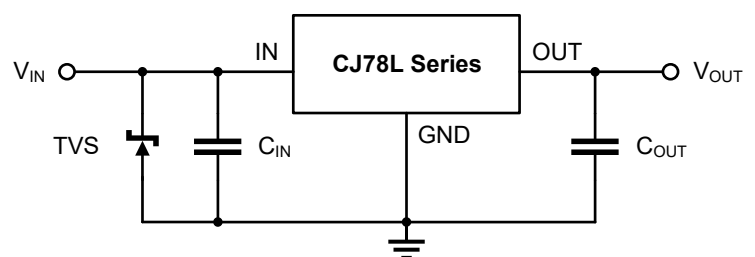

Figure 9-4. TVS is used at IN

## 9 Application and Implementation

### 9.2 Typical Application Circuits (continued)

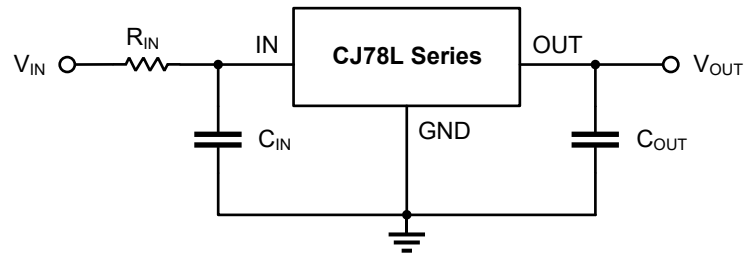

Figure 9-5. Resistance is used at IN

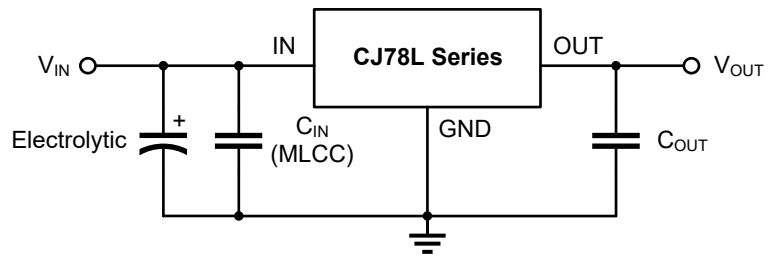

Figure 9-6. Electrolytic capacitor is used at IN

### 9.3 Bypass Capacitance Selection

A capacitance between IN and GND ( $C_{IN}$ ) is required if the regulator is located far from the power supply filter. It is recommended to use a  $0.33\mu\text{F}$  capacitor for  $C_{IN}$ , and the capacitor ( $C_{IN}$ ) should be placed as close to the device IN pin and GND pin as possible.

It is recommended to use a  $0.1\mu\text{F}$  capacitor between OUT and GND ( $C_{OUT}$ ), and the capacitor should be placed as close as possible between OUT and GND. The output capacitance can limit the high-frequency noise and help the device obtain the best stability and transient response.

The tolerance and temperature coefficient of the input and output capacitor ( $C_{IN}$  and  $C_{OUT}$ ) must be considered to ensure that the capacitor can work normally within the rated working ambient temperature and rated working conditions of the equipment.

It is recommended that the output capacitor ( $C_{OUT}$ ) should not exceed  $20\mu\text{F}$ . When the output capacitor ( $C_{OUT}$ ) exceeds  $20\mu\text{F}$ , it is recommended to use the circuit layout shown in Figure 9-2. See *Large Output Capacitance* for more details.

### 9.4 Design Requirements and Procedure

The CJ78L series is mainly used to provide fixed output voltage regulation, the output voltage is selected based on the device variant, which is available in 5.0V, 6.0V, 8.0V, 9.0V, 12V and 15V regulator options, and it requires a very small number of equipment components. If the regulator is far from the power filter, the input capacitor  $C_{IN}$  is required. The bypass capacitor  $C_{OUT}$  is used at the output to obtain the best stability and transient response. These capacitors must be as close to the regulator as possible.

### 9.5 Power Supply Recommendation

The linear regulator input supply must be well regulated and kept at a voltage level to not exceed the maximum input to output voltage differential allowed by the device. The minimum dropout voltage ( $V_{DO}$ ) must be met with extra headroom when possible to keep the output well regulated.

For the best overall performance, some layout guidelines may be disregarded. Place all circuit components on the same side of the circuit board and as near as practical to the respective linear regulator pins. Traces must be kept short and wide to reduce the amount of parasitic elements in the system. The actual width and thickness of traces depends on the current carrying capability and heat dissipation required by the end system.

#### NOTE

The application information in this section is not part of the data sheet component specification, and JSCJ makes no commitment or statement to guarantee its accuracy or completeness. Customers are responsible for determining the rationality of corresponding components in their circuit design and making tests and verifications to ensure the normal realization of their circuit design.

10 Mechanical Information

10.1 SOT-23-3L Mechanical Information

SOT-23-3L Outline Dimensions

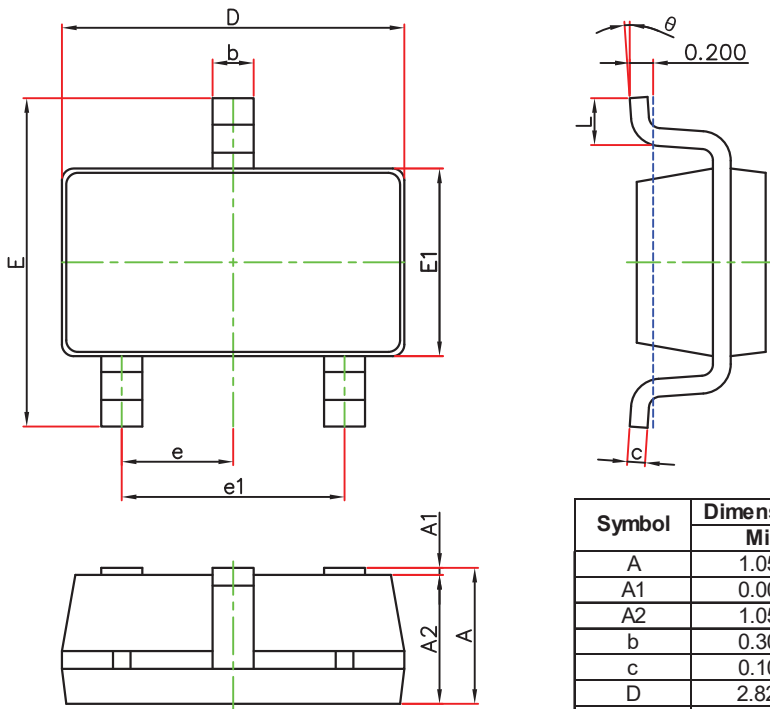

Symbol	Dimensions In Millimeters		Dimensions In Inches	
	Min.	Max.	Min.	Max.
A	1.050	1.250	0.041	0.049
A1	0.000	0.100	0.000	0.004
A2	1.050	1.150	0.041	0.045
b	0.300	0.500	0.012	0.020
c	0.100	0.200	0.004	0.008
D	2.820	3.020	0.111	0.119
E1	1.500	1.700	0.059	0.067
E	2.650	2.950	0.104	0.116
e	0.950(BSC)		0.037(BSC)	
e1	1.800	2.000	0.071	0.079
L	0.300	0.600	0.012	0.024
K	0°	8°	0°	8°

SOT-23-3L Suggested Pad Layout

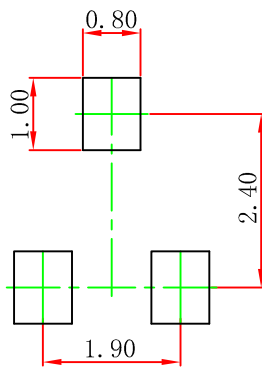

Note:

1. Controlling dimension: in millimeters.
2. General tolerance: ±0.05mm.
3. The pad layout is for reference purpose only.

10 Mechanical Information

10.2 SOT-89-3L Mechanical Information

SOT-89-3L Outline Dimensions

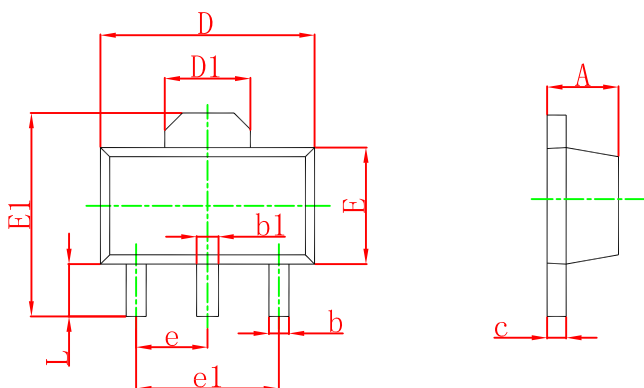

Symbol	Dimensions In Millimeters		Dimensions In Inches	
	Min	Max	Min	Max
A	1.400	1.600	0.055	0.063
b	0.320	0.520	0.013	0.020
b1	0.400	0.580	0.016	0.023
c	0.350	0.440	0.014	0.017
D	4.400	4.600	0.173	0.181
D1	1.550 REF.		0.061 REF.	
E	2.300	2.600	0.091	0.102
E1	3.940	4.250	0.155	0.167
e	1.500 TYP.		0.060 TYP.	
e1	3.000 TYP.		0.118 TYP.	
L	0.900	1.200	0.035	0.047

SOT-89-3L Suggested Pad Layout

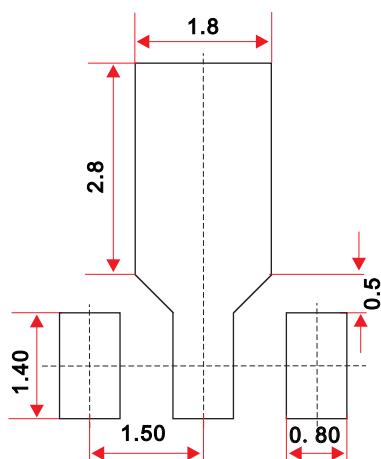

Note:

1. Controlling dimension: in millimeters.
2. General tolerance:  $\pm 0.05\text{mm}$ .
3. The pad layout is for reference purpose only.

10 Mechanical Information

10.3 TO-92 Mechanical Information

TO-92 Outline Dimensions

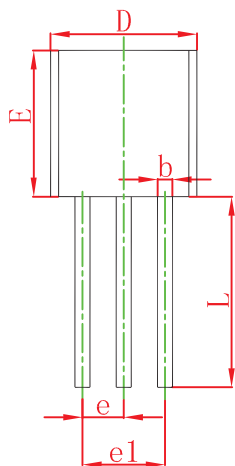
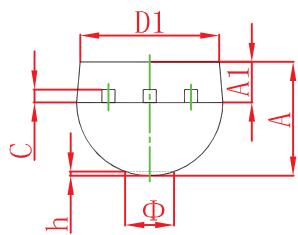

Symbol	Dimensions In Millimeters		Dimensions In Inches	
	Min	Max	Min	Max
A	3.300	3.700	0.130	0.146
A1	1.100	1.400	0.043	0.055
b	0.380	0.550	0.015	0.022
c	0.360	0.510	0.014	0.020
D	4.400	4.700	0.173	0.185
D1	3.430		0.135	
E	4.300	4.700	0.169	0.185
e	1.270 TYP		0.050 TYP	
e1	2.440	2.640	0.096	0.104
L	14.100	14.500	0.555	0.571
K		1.600		0.063
h	0.000	0.380	0.000	0.015

TO-92 Suggested Pad Layout

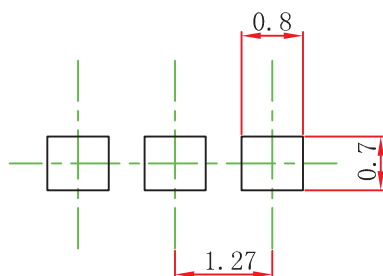

Note:

1. Controlling dimension: in millimeters.
2. General tolerance:  $\pm 0.05\text{mm}$ .
3. The pad layout is for reference purpose only.

## 11 Package Information

### 11.1 SOT-23-3L Tape and Reel Information

#### Embossed Carrier Tape

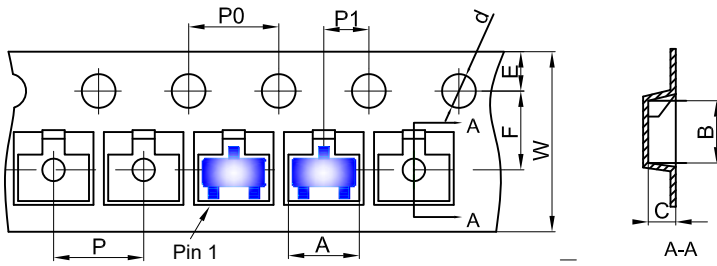

**Packaging Description:**

SOT-23-3L parts are shipped in tape. The carrier tape is made from a dissipative (carbon filled) polycarbonate resin. The cover tape is a multilayer film (Heat Activated Adhesive in nature) primarily composed of polyester film, adhesive layer, sealant, and anti-static sprayed agent. These reeled parts in standard option are shipped with 3,000 units per 7" or 18.0cm diameter reel. The reels are clear in color and is made of polystyrene plastic (anti-static coated).

Dimensions are in millimeter										
Pkg type	A	B	C	d	E	F	P0	P	P1	W
SOT-23-3L	3.18	3.28	1.32	Ø1.50	1.75	3.50	4.00	4.00	2.00	8.00

#### SOT-23-3L Tape Leader and Trailer

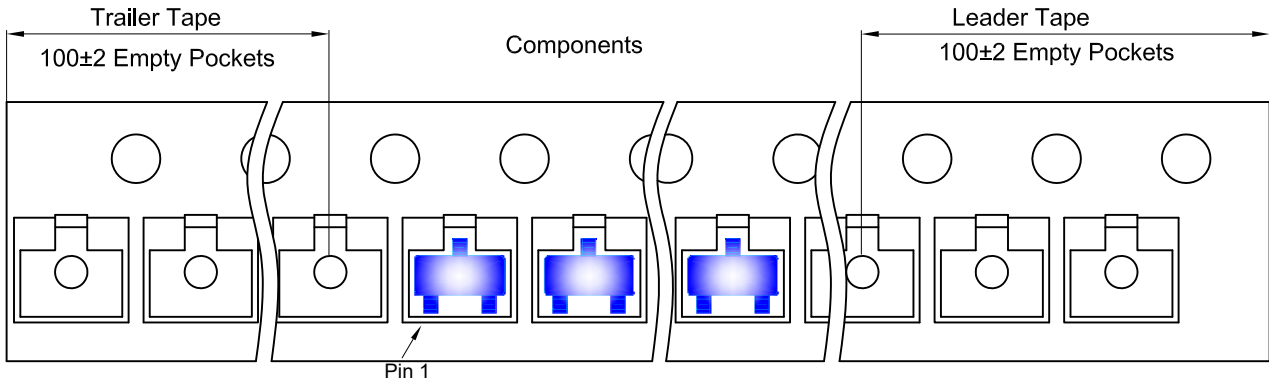

#### SOT-23-3L Reel

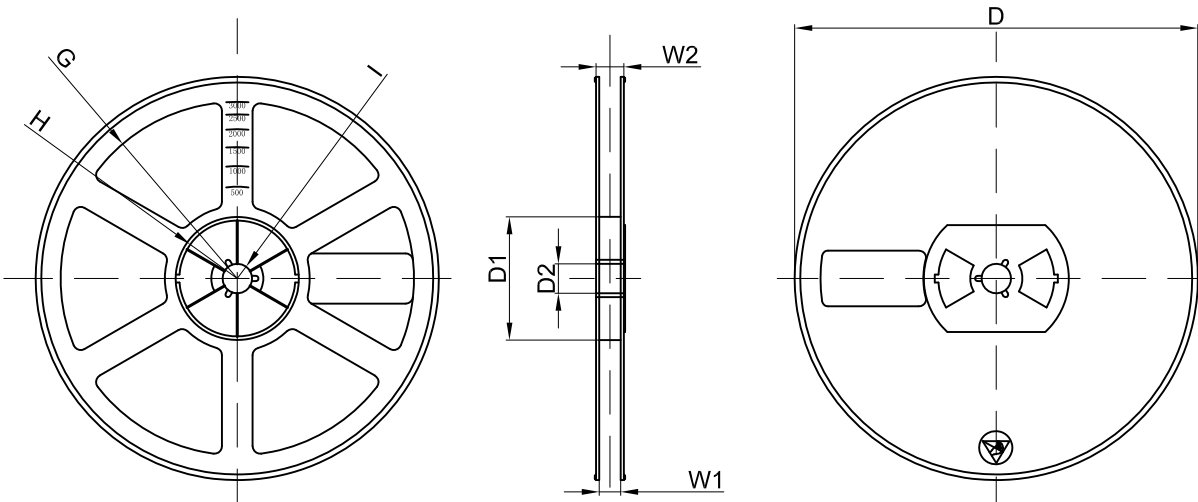

Dimensions are in millimeter								
Reel Option	D	D1	D2	G	H	I	W1	W2
7" Dia	Ø180.00	60.00	13.00	R78.00	R25.60	R6.50	9.50	13.10

REEL	Reel Size	Box	Box Size(mm)	Carton	Carton Size(mm)	G.W.(kg)
3000 pcs	7 inch	30,000 pcs	203×203×195	120,000 pcs	438×438×220	



## 11 Package Information

### 11.2 SOT-89-3L Tape and Reel Information

#### Embossed Carrier Tape

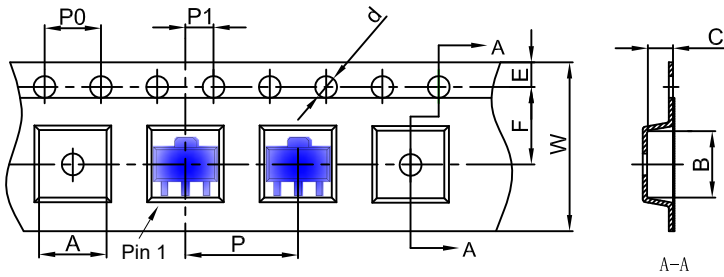

**Packaging Description:**  
 SOT-89-3L parts are shipped in tape. The carrier tape is made from a dissipative (carbon filled) polycarbonate resin. The cover tape is a multilayer film (Heat Activated Adhesive in nature) primarily composed of polyester film, adhesive layer, sealant, and anti-static sprayed agent. These reeled parts in standard option are shipped with 1,000 units per 7" or 18.0 cm diameter reel. The reels are clear in color and is made of polystyrene plastic (anti-static coated).

Dimensions are in millimeter										
Pkg type	A	B	C	d	E	F	P0	P	P1	W
SOT-89-3L	4.85	4.45	1.85	Ø1.50	1.75	5.50	4.00	8.00	2.00	12.00

#### SOT-89-3L Tape Leader and Trailer

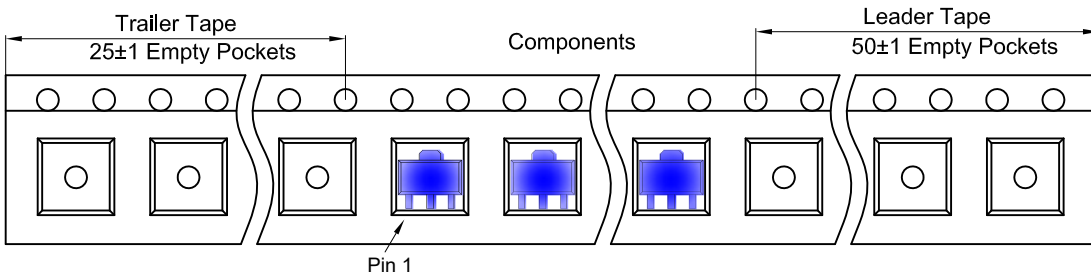

#### SOT-89-3L Reel

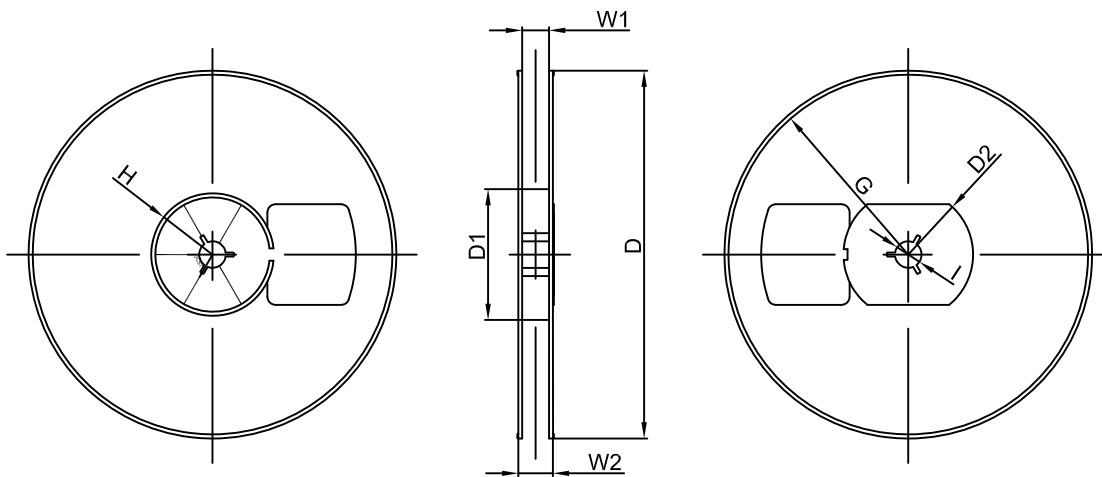

Dimensions are in millimeter								
Reel Option	D	D1	D2	G	H	I	W1	W2
7" Dia	Ø180.00	60.00	R32.00	R86.50	R30.00	Ø13.00	13.20	16.50

REEL	Reel Size	Box	Box Size(mm)	Carton	Carton Size(mm)	G.W.(kg)
1000 pcs	7 inch	10,000 pcs	203×203×195	40,000 pcs	438×438×220	

11 Package Information

11.3 TO-92 Tape and Reel Information

Embossed Carrier Tape

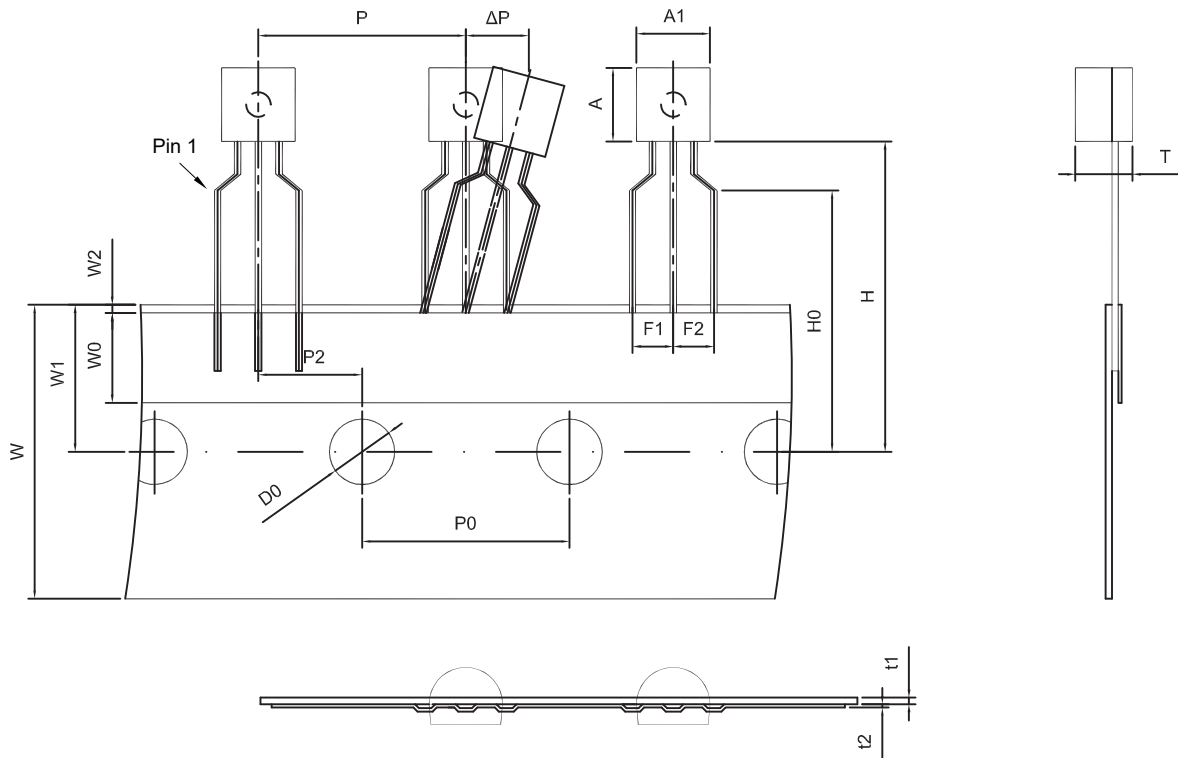

Dimiensions are in millimeter								
A1	A	T	P	P0	P2	F1	F2	W
4.5	4.5	3.5	12.7	12.7	6.35	2.5	2.5	18.0
W0	W1	W2	H	H0	D0	t1	t2	ΔP
6.0	9.0	1.0 MAX.	19.0	16.0	4.0	0.4	0.2	0

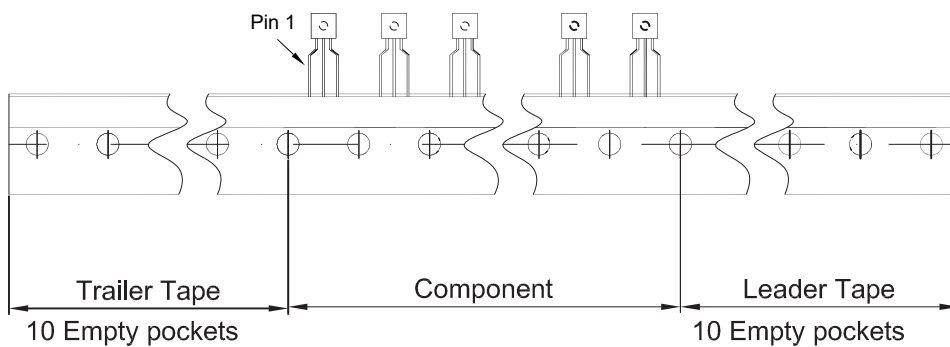

Package	Box	Box Size(mm)	Carton	Carton Size(mm)
TO-92	2000 pcs	333×162×43	20,000 pcs	350×340×250

## 12 Notes and Revision History

### 12.1 Associated Product Family and Others

To view other products of the same type or IC products of other types, please click the official website of JSCJ -- <https://www.jscj-elec.com> for more details.

### 12.2 Notes

#### Electrostatic Discharge Caution



This IC may be damaged by ESD. Relevant personnel shall comply with correct installation and use specifications to avoid ESD damage to the IC. If appropriate measures are not taken to prevent ESD damage, the hazards caused by ESD include but are not limited to degradation of integrated circuit performance or complete damage of integrated circuit. For some precision integrated circuits, a very small parameter change may cause the whole device to be inconsistent with its published specifications.

### 12.3 Revision History

#### May, 2023: changed from rev - 3.1 to rev - 3.2:

- Added the information of  $\pm 2\%$  grade products;
- Page 4, Marking Information, modified the marking description information for SOT-89-3L;
- Page 5, Absolute Maximum Ratings, removed the error message about SOT-23-5L;
- Page 5, Recommend Operating Conditions, removed the notes;
- Page 6, Thermal Information, added the  $R_{JC}$  information;
- Page 9, Electrical Characteristics, added the note about test conditions;
- Page 18, Risk Alert and Precautions, added the information about "Using Electrolytic Capacitor";
- Page 24 to 26, Package Information, added indication for position pin 1;
- Page 27, Notes, removed the notes about  $R_{JA}$  and  $P_{D Ref}$ .

#### September, 2022: changed from rev - 3.0 to rev - 3.1:

- Changed the data sheet layout to JSCJ format;
- Page 25, SOT-89-3L Suggested Pad Layout, changed recommended pads.

#### September, 2022: released CJ78L series, rev - 3.0:

- Modified data sheet format;
- All data sheet, added headers, changed font size;
- Page 1, modified footer;
- Assembled CJ78L05, CJ78L06, CJ78L08, CJ78L09, CJ78L12 and CJ78L15 devices into the CJ78L series;
- Deleted obsolete CJ78L18 device from the data sheet;
- Added Introduction, Available Package, Applications, Pin Configuration and Marking Information, Recommended Operating Conditions, ESD Ratings, Thermal Information, Detailed Description, Application and Implementation and Notes and Revision History sections

# DISCLAIMER

## **IMPORTANT NOTICE, PLEASE READ CAREFULLY**

The information in this data sheet is intended to describe the operation and characteristics of our products. JSCJ has the right to make any modification, enhancement, improvement, correction or other changes to any content in this data sheet, including but not limited to specification parameters, circuit design and application information, without prior notice.

Any person who purchases or uses JSCJ products for design shall: 1. Select products suitable for circuit application and design; 2. Design, verify and test the rationality of circuit design; 3. Procedures to ensure that the design complies with relevant laws and regulations and the requirements of such laws and regulations. JSCJ makes no warranty or representation as to the accuracy or completeness of the information contained in this data sheet and assumes no responsibility for the application or use of any of the products described in this data sheet.

Without the written consent of JSCJ, this product shall not be used in occasions requiring high quality or high reliability, including but not limited to the following occasions: medical equipment, military facilities and aerospace. JSCJ shall not be responsible for casualties or property losses caused by abnormal use or application of this product.

Official Website: [www.jscj-elec.com](http://www.jscj-elec.com)

Copyright © JIANGSU CHANGJING ELECTRONICS TECHNOLOGY CO., LTD.