

TO-92 Plastic-Encapsulate Transistors

MPSA55 TRANSISTOR (PNP)

FEATURES

- General Purpose Amplifier

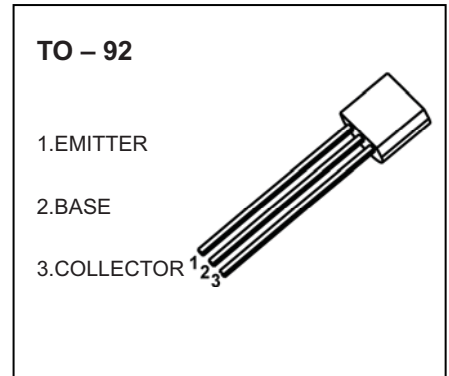

MARKING

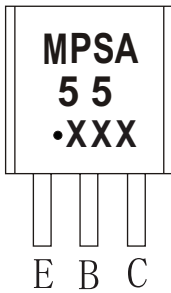

MPSA55=Device code
 Solid dot=Green molding compound device,
 if none,the normal device
 XXX=Code

Equivalent Circuit

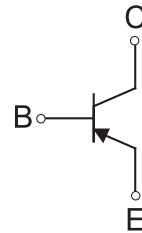

ORDERING INFORMATION

Part Number	Package	Packing Method	Pack Quantity
MPSA55	TO-92	Bulk	1000pcs/Bag
MPSA55-TA	TO-92	Tape	2000pcs/Box

MAXIMUM RATINGS (T_a=25°C unless otherwise noted)

Symbol	Parameter	Value	Unit
V _{CB0}	Collector-Base Voltage	-60	V
V _{CEO}	Collector-Emitter Voltage	-60	V
V _{EBO}	Emitter-Base Voltage	-4	V
I _c	Collector Current -Continuous	-0.5	A
P _D	Collector Power Dissipation	625	mW
R _{θJA}	Thermal Resistance from Junction to Ambient	200	°C /W
T _j	Junction Temperature	150	°C
T _{stg}	Storage Temperature	-55~+150	°C

ELECTRICAL CHARACTERISTICS

$T_a=25^\circ\text{C}$ unless otherwise specified

Parameter	Symbol	Test conditions	Min	Typ	Max	Unit
Collector-base breakdown voltage	$V_{(BR)CBO}$	$I_C = -0.1\text{mA}, I_E = 0$	-60			V
Collector-emitter breakdown voltage	$V_{(BR)CEO}$	$I_C = -1\text{mA}, I_B = 0$	-60			V
Emitter-base breakdown voltage	$V_{(BR)EBO}$	$I_E = -0.1\text{mA}, I_C = 0$	-4			V
Collector cut-off current	I_{CBO}	$V_{CB} = -60\text{V}, I_E = 0$			-0.1	μA
Collector cut-off current	I_{CEO}	$V_{CE} = -60\text{V}, I_B = 0$			-0.1	μA
Emitter cut-off current	I_{EBO}	$V_{EB} = -4\text{V}, I_C = 0$			-0.1	μA
DC current gain	$h_{FE(1)}$	$V_{CE} = -1\text{V}, I_C = -10\text{mA}$	100			
	$h_{FE(2)}$	$V_{CE} = -1\text{V}, I_C = -100\text{mA}$	100			
Collector-emitter saturation voltage	$V_{CE(sat)}$	$I_C = -100\text{mA}, I_B = -10\text{mA}$			-0.25	V
Base-emitter on voltage	V_{BE}	$I_C = -100\text{mA}, V_{CE} = -1\text{V}$			-1.2	V
Transition frequency	f_T	$V_{CE} = -1\text{V}, I_C = -100\text{mA}, f = 100\text{MHz}$	50			MHz

Typical Characteristics

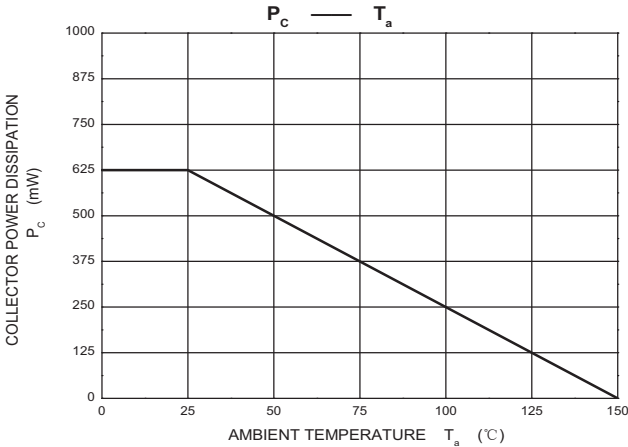
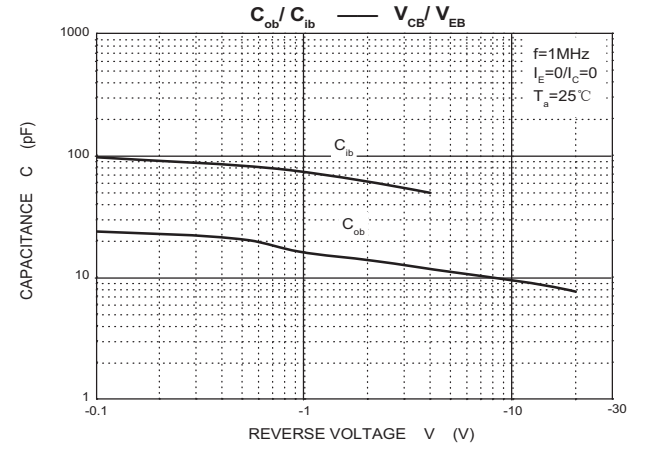
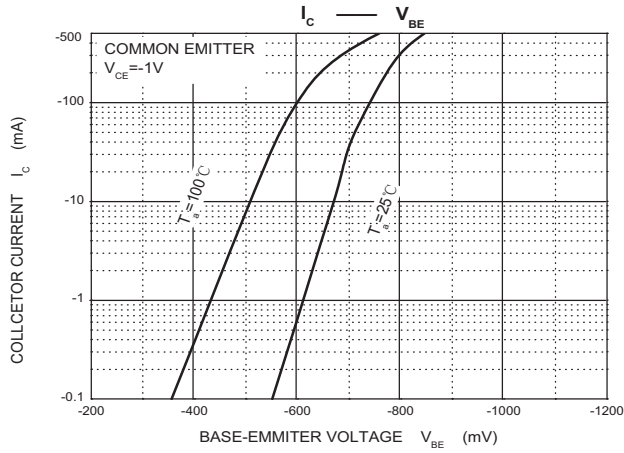
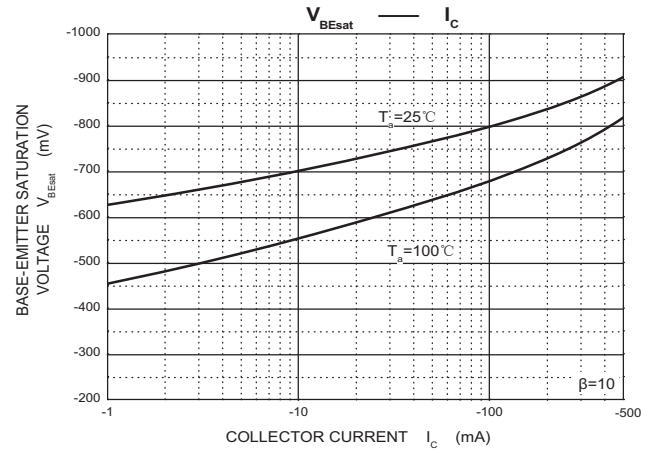
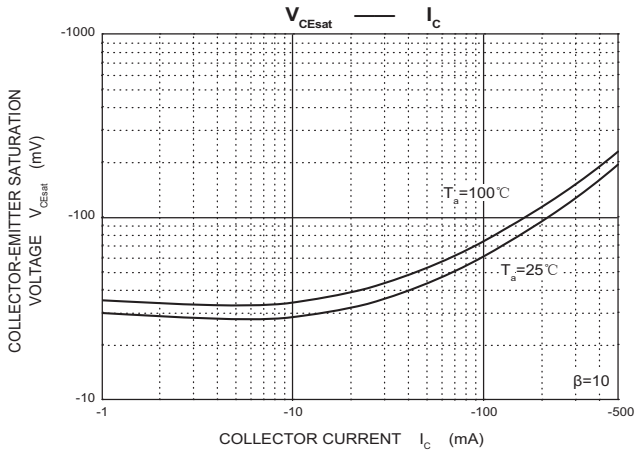
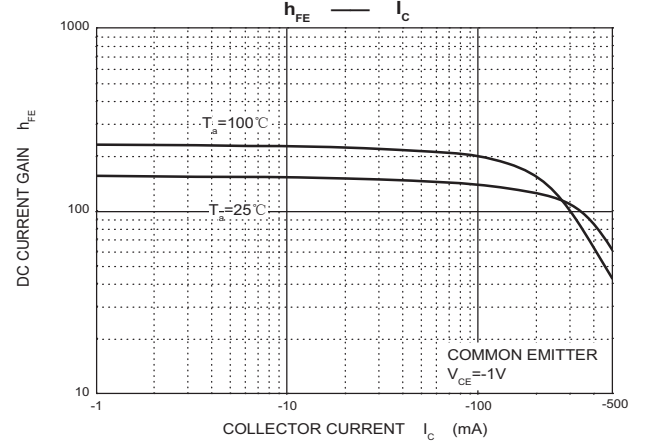
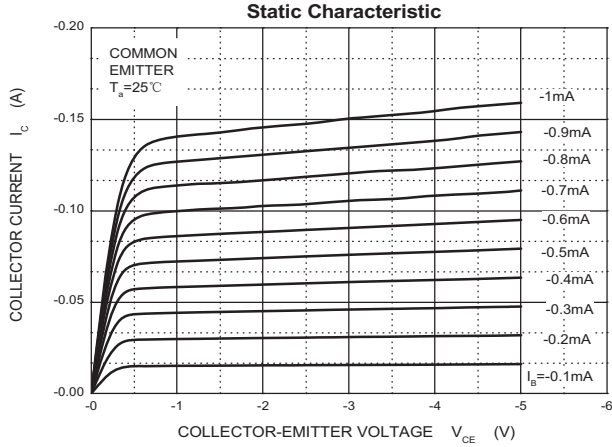

TO-92 Package Outline Dimensions

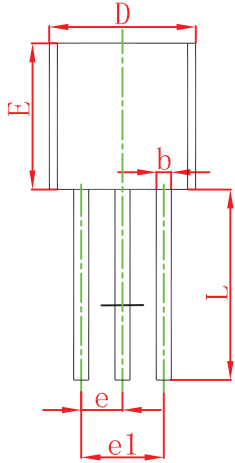
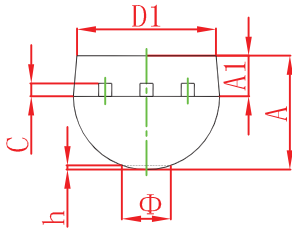

Symbol	Dimensions In Millimeters		Dimensions In Inches	
	Min	Max	Min	Max
A	3.300	3.700	0.130	0.146
A1	1.100	1.400	0.043	0.055
b	0.380	0.550	0.015	0.022
c	0.360	0.510	0.014	0.020
D	4.300	4.700	0.169	0.185
D1	3.430		0.135	
E	4.300	4.700	0.169	0.185
e	1.270 TYP		0.050 TYP	
e1	2.440	2.640	0.096	0.104
L	14.100	14.500	0.555	0.571
Φ		1.600		0.063
h	0.000	0.380	0.000	0.015

TO-92 Suggested Pad Layout

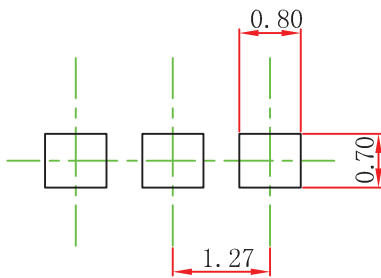

Note:

1. Controlling dimension: in millimeters.
2. General tolerance: $\pm 0.05\text{mm}$.
3. The pad layout is for reference purposes only.

NOTICE

JCET reserve the right to make modifications, enhancements, improvements, corrections or other changes without further notice to any product herein. JCET does not assume any liability arising out of the application or use of any product described herein.

TO-92 PACKAGE TAPEING DIMENSION

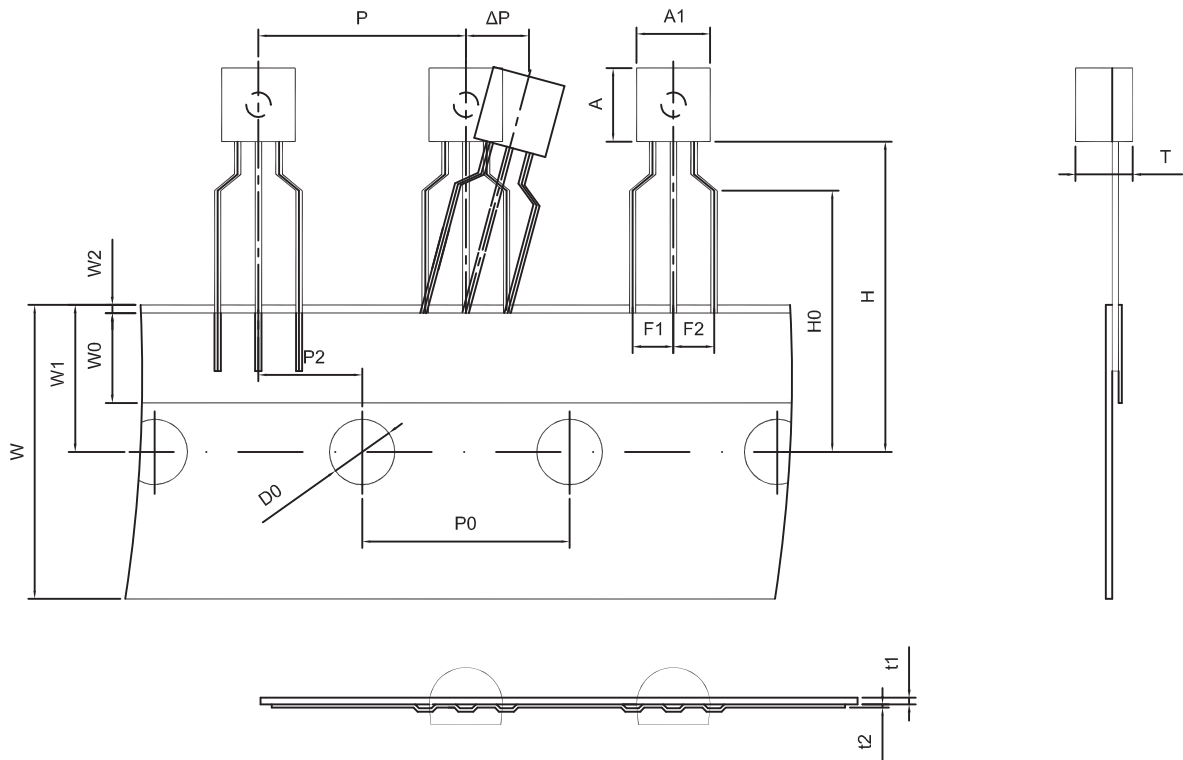

Dimiensions are in millimeter								
A1	A	T	P	P0	P2	F1	F2	W
4.5	4.5	3.5	12.7	12.7	6.35	2.5	2.5	18.0
W0	W1	W2	H	H0	D0	t1	t2	ΔP
6.0	9.0	1.0 MAX.	19.0	16.0	4.0	0.4	0.2	0

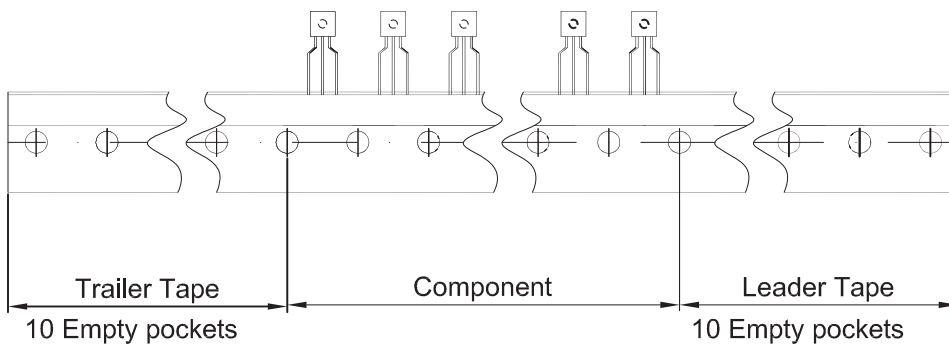

Package	Box	Box Size(mm)	Carton	Carton Size(mm)
TO-92	2000 pcs	333×162×43	20,000 pcs	350×340×250