



**TO-220F Plastic-Encapsulate Transistors**

**TIP127F** DARLINGTON TRANSISTOR (PNP)

**FEATURES**

- Medium Power Complementary Silicon Transistors

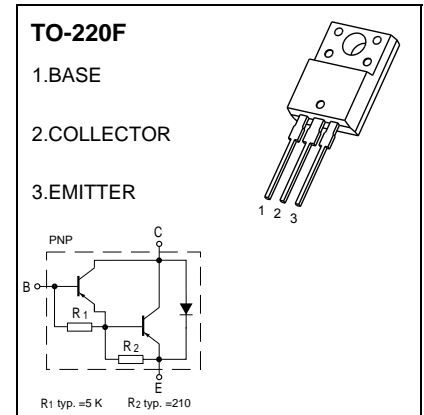

**MARKING**

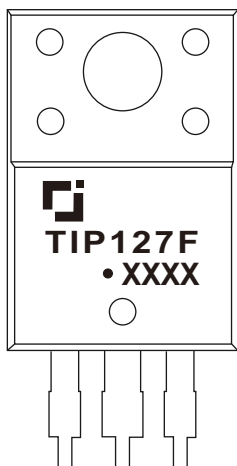

TIP127F=Device code  
 Solid dot=Green moldinn compound device,  
 if none,the normal device  
 XXXX=Code

**MAXIMUM RATINGS (Ta=25°C unless otherwise noted)**

Symbol	Parameter	Value	Unit
V <sub>CBO</sub>	Collector-Base Voltage	-100	V
V <sub>CEO</sub>	Collector-Emitter Voltage	-100	V
V <sub>EBO</sub>	Emitter-Base Voltage	-5	V
I <sub>C</sub>	Collector Current -Continuous	-5	A
P <sub>C</sub>	Collector Power Dissipation	2	W
R <sub>θJA</sub>	Thermal Resistance, Junction to Ambient	62.5	°C/W
R <sub>θJC</sub>	Thermal Resistance, Junction to Case	1.92	°C/W
T <sub>J</sub> , T <sub>stg</sub>	Operation Junction and Storage Temperature Range	-55~+150	°C

**ELECTRICAL CHARACTERISTICS (T<sub>a</sub>=25°C unless otherwise specified)**

Parameter	Symbol	Test conditions	Min	Max	Unit
Collector-base breakdown voltage	V <sub>(BR)CBO</sub>	I <sub>C</sub> = -1mA, I <sub>E</sub> =0	-100		V
Collector-emitter breakdown voltage	V <sub>CEO(SUS)</sub>	I <sub>C</sub> = -30mA, I <sub>B</sub> =0	-100		V
Collector cut-off current	I <sub>CBO</sub>	V <sub>CB</sub> =-100V, I <sub>E</sub> =0		-0.2	mA
Collector cut-off current	I <sub>CEO</sub>	V <sub>CE</sub> =-50 V, I <sub>B</sub> =0		-0.5	mA
Emitter cut-off current	I <sub>EBO</sub>	V <sub>EB</sub> =-5 V, I <sub>C</sub> =0		-2	mA
DC current gain	h <sub>FE(1)</sub>	V <sub>CE</sub> = -3V, I <sub>C</sub> =-0.5A	1000		
	h <sub>FE(2)</sub>	V <sub>CE</sub> = -3V, I <sub>C</sub> =-3 A	1000	12000	
Collector-emitter saturation voltage	V <sub>CE(sat)</sub>	I <sub>C</sub> =-3A, I <sub>B</sub> =-12mA I <sub>C</sub> =-5 A, I <sub>B</sub> =-20mA		-2 -4	V
Base-emitter voltage	V <sub>BE</sub>	V <sub>CE</sub> = -3V, I <sub>C</sub> =-3 A		-2.5	V
Output Capacitance	C <sub>ob</sub>	V <sub>CB</sub> =-10V, I <sub>E</sub> =0, f=0.1MHz		300	pF

# Typical Characteristics

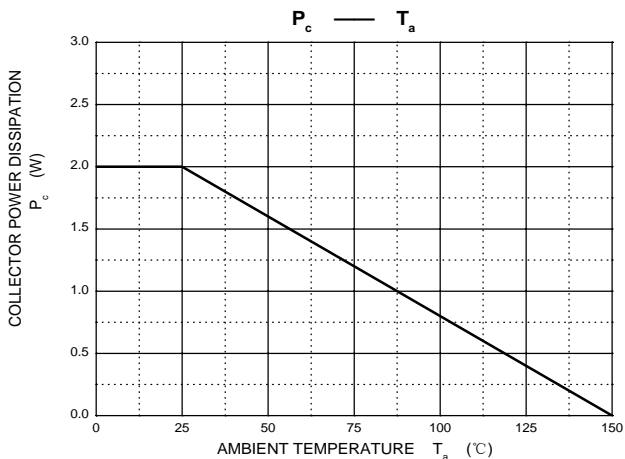
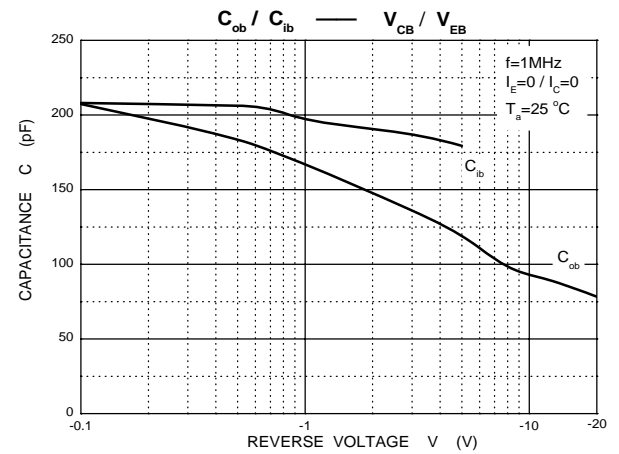
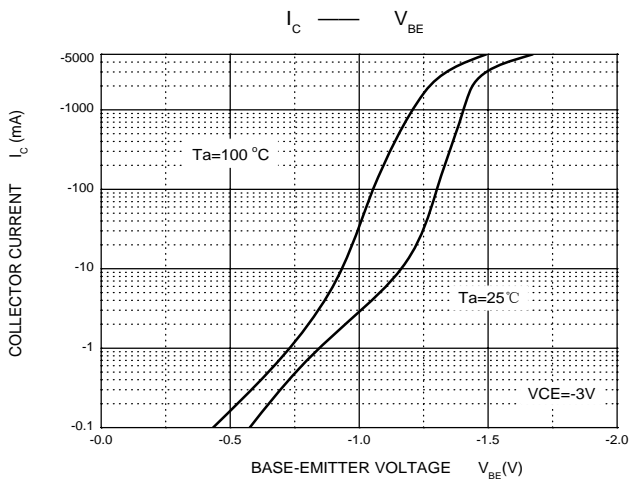
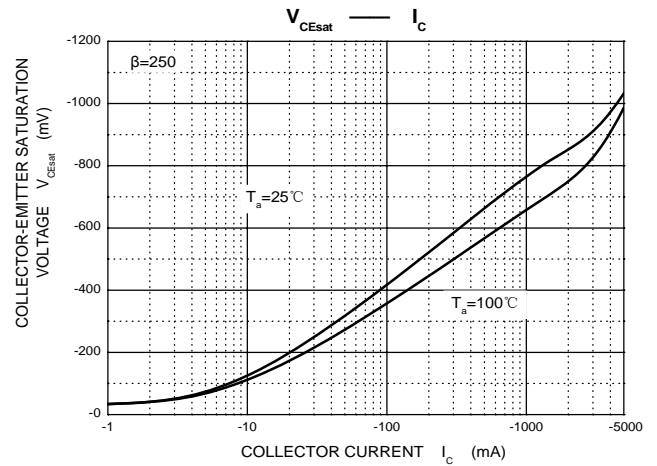
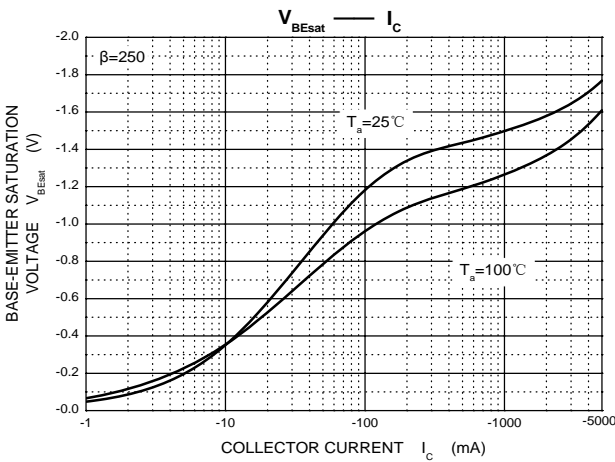
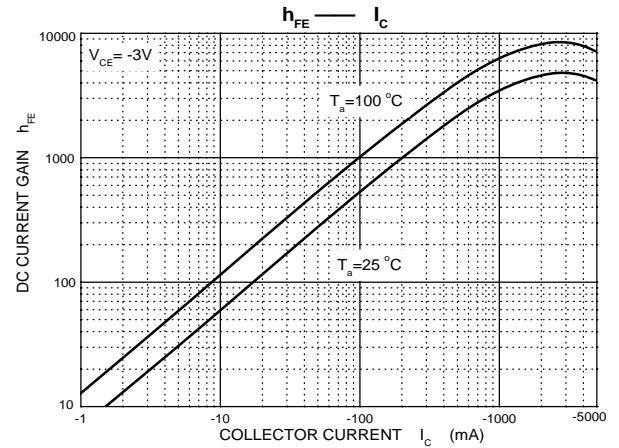
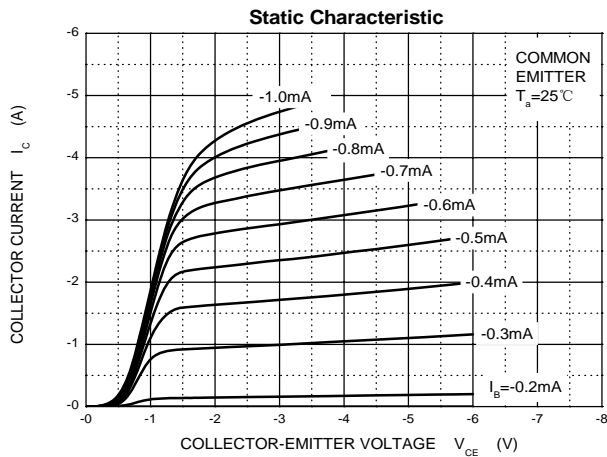

# TO-220F Package Outline Dimensions

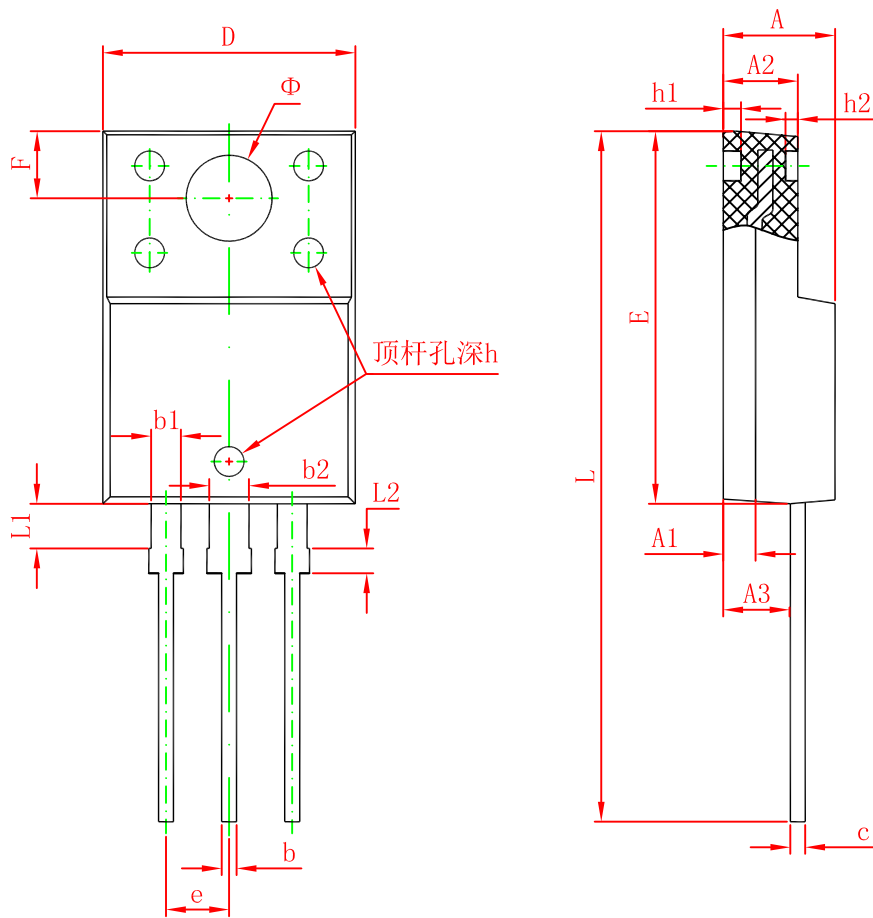

Symbol	Dimensions In Millimeters		Dimensions In Inches	
	Min.	Max.	Min.	Max.
A	4.300	4.700	0.169	0.185
A1	1.300 REF.		0.051 REF.	
A2	2.800	3.200	0.110	0.126
A3	2.500	2.900	0.098	0.114
b	0.500	0.750	0.020	0.030
b1	1.100	1.350	0.043	0.053
b2	1.500	1.750	0.059	0.069
c	0.500	0.750	0.020	0.030
D	9.960	10.360	0.392	0.408
E	14.800	15.200	0.583	0.598
e	2.540 TYP.		0.100 TYP.	
F	2.700 REF.		0.106 REF.	
Φ	3.500 REF.		0.138 REF.	
h	0.000	0.300	0.000	0.012
h1	0.800 REF.		0.031 REF.	
h2	0.500 REF.		0.020 REF.	
L	28.000	28.400	1.102	1.118
L1	1.700	1.900	0.067	0.075
L2	0.900	1.100	0.035	0.043