



Is Now Part of



**ON Semiconductor®**

To learn more about ON Semiconductor, please visit our website at  
[www.onsemi.com](http://www.onsemi.com)

Please note: As part of the Fairchild Semiconductor integration, some of the Fairchild orderable part numbers will need to change in order to meet ON Semiconductor's system requirements. Since the ON Semiconductor product management systems do not have the ability to manage part nomenclature that utilizes an underscore (\_), the underscore (\_) in the Fairchild part numbers will be changed to a dash (-). This document may contain device numbers with an underscore (\_). Please check the ON Semiconductor website to verify the updated device numbers. The most current and up-to-date ordering information can be found at [www.onsemi.com](http://www.onsemi.com). Please email any questions regarding the system integration to [Fairchild\\_questions@onsemi.com](mailto:Fairchild_questions@onsemi.com).

ON Semiconductor and the ON Semiconductor logo are trademarks of Semiconductor Components Industries, LLC dba ON Semiconductor or its subsidiaries in the United States and/or other countries. ON Semiconductor owns the rights to a number of patents, trademarks, copyrights, trade secrets, and other intellectual property. A listing of ON Semiconductor's product/patent coverage may be accessed at [www.onsemi.com/site/pdf/Patent-Marking.pdf](http://www.onsemi.com/site/pdf/Patent-Marking.pdf). ON Semiconductor reserves the right to make changes without further notice to any products herein. ON Semiconductor makes no warranty, representation or guarantee regarding the suitability of its products for any particular purpose, nor does ON Semiconductor assume any liability arising out of the application or use of any product or circuit, and specifically disclaims any and all liability, including without limitation special, consequential or incidental damages. Buyer is responsible for its products and applications using ON Semiconductor products, including compliance with all laws, regulations and safety requirements or standards, regardless of any support or applications information provided by ON Semiconductor. "Typical" parameters which may be provided in ON Semiconductor data sheets and/or specifications can and do vary in different applications and actual performance may vary over time. All operating parameters, including "Typicals" must be validated for each customer application by customer's technical experts. ON Semiconductor does not convey any license under its patent rights nor the rights of others. ON Semiconductor products are not designed, intended, or authorized for use as a critical component in life support systems or any FDA Class 3 medical devices or medical devices with a same or similar classification in a foreign jurisdiction or any devices intended for implantation in the human body. Should Buyer purchase or use ON Semiconductor products for any such unintended or unauthorized application, Buyer shall indemnify and hold ON Semiconductor and its officers, employees, subsidiaries, affiliates, and distributors harmless against all claims, costs, damages, and expenses, and reasonable attorney fees arising out of, directly or indirectly, any claim of personal injury or death associated with such unintended or unauthorized use, even if such claim alleges that ON Semiconductor was negligent regarding the design or manufacture of the part. ON Semiconductor is an Equal Opportunity/Affirmative Action Employer. This literature is subject to all applicable copyright laws and is not for resale in any manner.

# FMS6151 Ultra-Portable Video Filter Driver

## Features

- 5th-Order 8MHz (SD) Filter
- Power Down to 25nA
- DC-Coupled Input
- AC- or DC-Coupled Output
- DC-Coupled Output Eliminates AC-Coupling Cap
- SAG Correction Reduces Size of AC-Coupling Cap
- Fixed Gain of 6dB
- Small, Lead-Free, MicroPak™ Packaging

## Applications

- Digital Still Cameras
- Camera Phones
- Personal Digital Assistants
- Set Top Boxes
- Digital Video Recorders

## Description

The FMS6151 low-cost integrated video filter is intended to replace passive LC filters and drivers in low-voltage portable video applications. The 5th-order filter provides better image quality compared to typical 2nd- and 3rd-order passive solutions.

The FMS6151 is intended to be directly driven by a DC-coupled DAC output. The output can drive an AC- or DC-coupled doubly terminated coax (150Ω) load. DC-coupling the output removes the need for an expensive output coupling capacitor. If an AC-coupled output is needed, the SAG correction circuit can be used to reduce the AC output coupling capacitor value. Input DC levels are offset by approximately 100mV. This internal level shift is incorporated to prevent sync pulse clipping.

Offering SAG correction, 6dB fixed gain, and a 5th-order low-pass filter in a space-saving MicroPak™ package makes the FMS6151 well suited for space-sensitive applications, such as cellular phones and digital cameras.

## Block Diagram

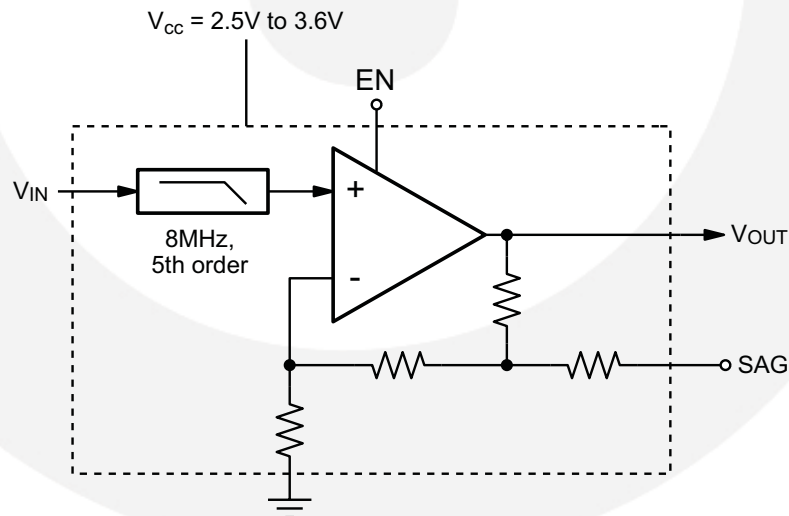

Figure 1. Block Diagram

## Ordering Information

Part Number	Operating Temperature Range	Package	Packaging Method
FMS6151L6X	-40°C to +105°C	6-Lead MicroPak™	Reel

## Pin Configuration

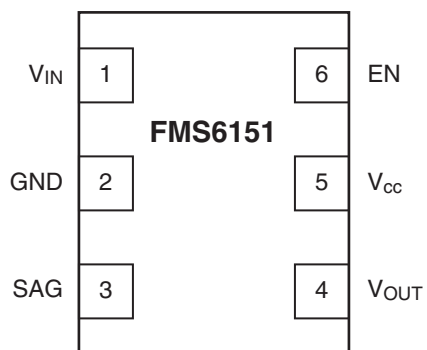

Figure 2. Pin Assignments

## Pin Assignments

Pin#	Pin Name	Type	Description
1	$V_{IN}$	Input	Input video
2	GND	Input	Ground
3	SAG	Input	SAG
4	$V_{OUT}$	Output	Filtered video output
5	$V_{CC}$	Input	Positive power supply
6	EN	Input	Enable 0 = Disabled 1 = Enabled

## Absolute Maximum Ratings

Stresses exceeding the absolute maximum ratings may damage the device. The device may not function or be operable above the recommended operating conditions and stressing the parts to these levels is not recommended. In addition, extended exposure to stresses above the recommended operating conditions may affect device reliability. The absolute maximum ratings are stress ratings only.

Parameter		Min.	Max.	Unit
DC Supply Voltage		-0.3	6.0	V
Analog and Digital I/O		-0.3	+V <sub>CC</sub> +0.3	V
Maximum Output Current, Do Not Exceed			45	mA
Electrostatic Discharge Protection Level	Human Body Model, JESD22-A114	6		kV
	Charged Device Model, JESD22-C101	2		

## Reliability Information

Parameter	Min.	Typ.	Max.	Unit
Junction Temperature			+150	°C
Storage Temperature Range	-65		+150	°C
Thermal Resistance ( $\theta_{JA}$ ), JDEC Standard, Multi-layer Test Boards, Still Air			271	°C/W

## Recommended Operating Conditions

The Recommended Operating Conditions table defines the conditions for actual device operation. Recommended operating conditions are specified to ensure optimal performance to the datasheet specifications. Fairchild does not recommend exceeding them or designing to absolute maximum ratings.

Parameter	Min.	Typ.	Max.	Unit
Operating Temperature Range	-40		+105	°C
Supply Voltage Range	2.5	2.7	3.6	V



## DC Electrical Characteristics

$T_A = 25^\circ\text{C}$ ,  $V_{CC} = 2.7\text{V}$ ,  $R_S = 37.5\Omega$ , AC-coupled output into  $150\Omega$  load, SAG pin connected to  $V_{OUT}$  pin, unless otherwise noted.

Symbol	Parameter	Conditions	Min.	Typ.	Max.	Units
$I_{CC}$	Supply Current <sup>(1)</sup>	$V_{CC} = 2.7\text{V}$ , No Load		3.8	6.4	mA
$V_{IN}$	Video Input Voltage Range	Referenced to GND		1.2		$V_{pp}$
Vols	Output Level Shift <sup>(1)</sup>	$V_{IN} = 0\text{V}$	50	200	350	mV
PSRR	Vols over power supply	$V_{CC} = 2.7\text{V}$ to $3.3\text{V}$		40		dB
$I_{SH}$	Shut Down Current			25		nA
$V_{il}$	Disabled Logic Low <sup>(1)</sup>		0		0.8	V
$V_{ih}$	Enabled Logic High <sup>(1)</sup>		$V_{CC} * 0.6$		$V_{CC}$	V
$t_{ON}$	Enable Time			1.5		$\mu\text{s}$
$t_{OFF}$	Disable Time			50		ns

## AC Electrical Characteristics

$T_A = 25^\circ\text{C}$ ,  $V_{CC} = 2.7\text{V}$ ,  $R_S = 37.5\Omega$ , AC-coupled output into  $150\Omega$  load, SAG pin connected to  $V_{OUT}$  pin, unless otherwise noted.

Symbol	Parameter	Conditions	Min.	Typ.	Max.	Units
$A_V$	Gain <sup>(1)</sup>	DC	6.0	6.2	6.4	dB
$f_{1dB}$	-1dB Bandwidth <sup>(1)</sup>		5.0	6.7		MHz
$f_c$	-3dB Bandwidth			8		MHz
$f_{SB}$	Attenuation <sup>(1)</sup> (Stopband Reject)	27MHz	40	47		dB
DG	Differential Gain			0.5		%
DP	Differential Phase			0.5		$^\circ$
SNR	Signal-to-Noise Ratio	NTC-7 Weighting, 100kHz to 4.2MHz		78		dB

**Note:**

1. 100% tested at  $25^\circ\text{C}$ .

### Typical Performance Characteristics

$T_A = 25^\circ\text{C}$ ,  $V_{CC} = 2.7\text{V}$ ,  $R_S = 37.5\Omega$ , AC-coupled output into  $150\Omega$  load, SAG pin connected to  $V_{OUT}$  pin, unless otherwise noted.

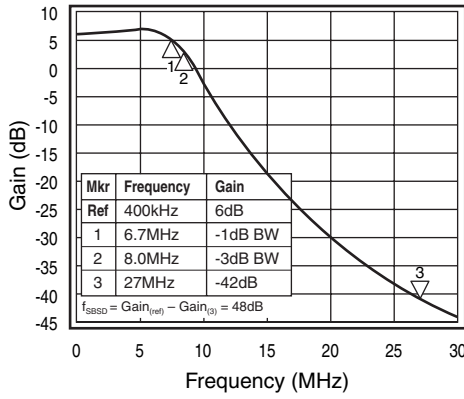

Figure 3. Frequency Response

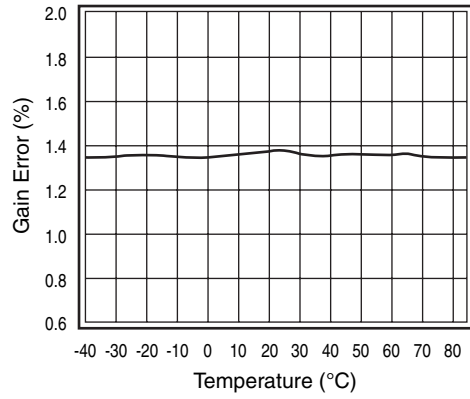

Figure 4. Gain Error vs. Temperature

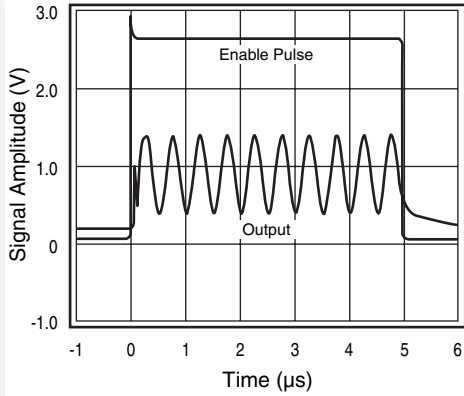

Figure 5. Enable/Disable Response

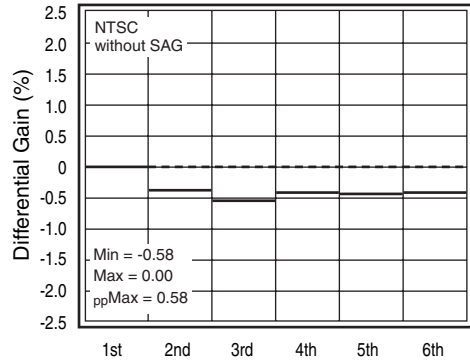

Figure 6. Differential Gain

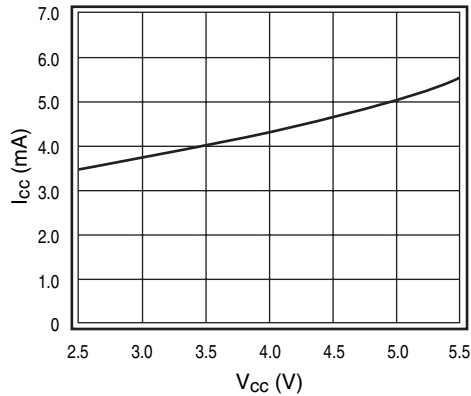

Figure 7.  $I_{CC}$  vs. Supply Voltage

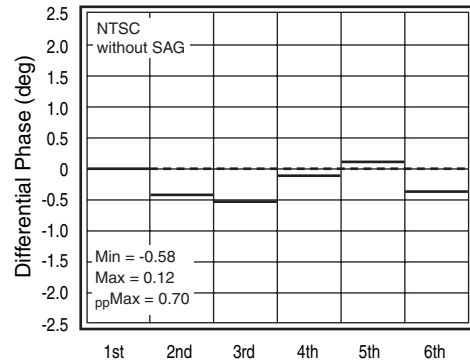

Figure 8. Differential Phase

### Typical Performance Characteristics

$T_A = 25^\circ\text{C}$ ,  $V_{CC} = 2.7\text{V}$ ,  $R_S = 37.5\Omega$ , AC-coupled output into  $150\Omega$  load, SAG pin connected to  $V_{OUT}$  pin, unless otherwise noted.

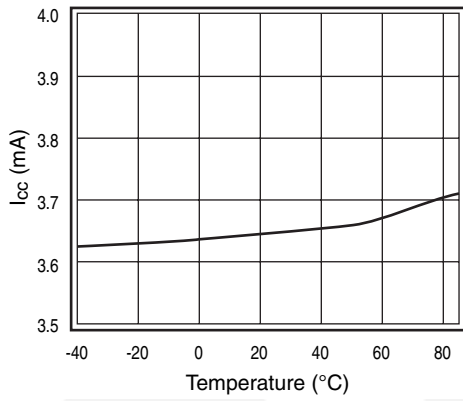

Figure 9. Supply Current vs. Temperature

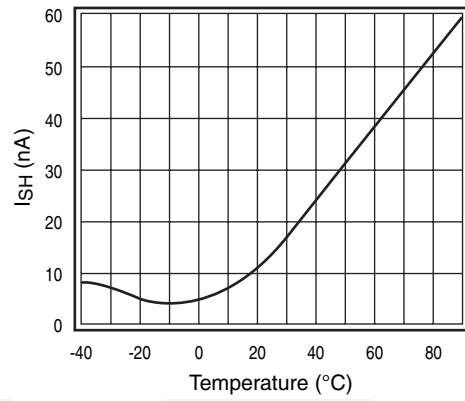

Figure 10. Shutdown Current vs. Temperature

## Application Information

### Input Voltage

The FMS6151 is intended to be directly driven by a DC-coupled DAC output. The input common-mode range of the FMS6151 is  $1.2V_{pp}$ , ground referenced.

### Enable/Shutdown

The FMS6151 has a shutdown feature that disables the output and reduces the quiescent current to  $\sim 25nA$ . This feature is especially useful in portable applications, such as cellular phones, hand held gaming devices, and video cameras requiring video filtering and drive capability.

### Internal Level Shift

The FMS6151 has an internal level-shift circuit to avoid sync tip clipping. The output signal is shifted 200mV toward the  $V_{CC}$  rail to help prevent clipping. This offset is useful when DC coupled out or using SAG correction.

### SAG Correction

SAG correction provides excellent performance with a small output coupling capacitor. It eliminates the  $220\mu F$  -  $1000\mu F$  output coupling capacitors traditionally used. The traditional output circuit ( $220\mu F$  into  $150\Omega$  load) creates a single pole ( $-3dB$ ) at 5Hz. Reducing this capacitor causes excessive phase shift, resulting in video field tilt that can prevent proper recovery of the synchronization signals.

The FMS6151 SAG correction circuit provides a small amount of peaking, which provides compensation of the phase response, significantly reducing video field tilt. The SAG correction circuit allows decrease of the large  $220\mu F$  output coupling capacitor. A  $22\mu F$  is used for SAG correction and a  $47\mu F$  is used for the output coupling capacitor; much smaller and cheaper than traditional circuit requirements.

### Output Configuration

The FMS6151 output is a low-impedance voltage driver. It is capable of driving an AC- or DC-coupled single load.

*For more application information, please refer to FMS6151 Application Note, AN-8005.*







**TRADEMARKS**

The following includes registered and unregistered trademarks and service marks, owned by Fairchild Semiconductor and/or its global subsidiaries, and is not intended to be an exhaustive list of all such trademarks.

- |                          |                                     |                                     |   |
|--------------------------|-------------------------------------|-------------------------------------|---|
| AccuPower™               | F-PFST™                             | Power-SPM™                          | <p>SYSTEM GENERAL®<br/>The Power Franchise®<br/>the power franchise<br/>TinyBoost™<br/>TinyBuck™<br/>TinyCalc™<br/>TinyLogic®<br/>TINYOPTO™<br/>TinyPower™<br/>TinyPWM™<br/>TinyWire™<br/>TriFault Detect™<br/>TRUECURRENT™<br/>μSerDes™<br/> SerDes™<br/>UHC®<br/>Ultra FRFET™<br/>UniFET™<br/>VCX™<br/>VisualMax™<br/>XS™</p> |
| Auto-SPM™                | FRFET®                              | PowerTrench®                        |   |
| Build it Now™            | Global Power Resource <sup>SM</sup> | PowerXS™                            |   |
| CorePLUS™                | Green FPS™                          | Programmable Active Droop™          |   |
| CorePOWER™               | Green FPS™ e-Series™                | QFET®                               |   |
| CROSSVOLT™               | Gmax™                               | QST™                                |   |
| CTL™                     | GTO™                                | Quiet Series™                       |   |
| Current Transfer Logic™  | IntelliMAX™                         | RapidConfigure™                     |   |
| DEUXPEED®                | ISOPLANAR™                          | ™                                   |   |
| Dual Cool™               | MegaBuck™                           | Saving our world, 1mW/kW at a time™ |   |
| EcoSPARK®                | MICROCOUPLER™                       | SignalWise™                         |   |
| EfficientMax™            | MicroFET™                           | SmartMax™                           |   |
| ESBC™                    | MicroPak™                           | SMART START™                        |   |
| ™                        | MicroPak2™                          | SPM®                                |   |
| Fairchild®               | MillerDrive™                        | STEALTH™                            |   |
| Fairchild Semiconductor® | MotionMax™                          | SuperFET™                           |   |
| FACT Quiet Series™       | Motion-SPM™                         | SuperSOT™-3                         |   |
| FACT®                    | OptoHIT™                            | SuperSOT™-6                         |   |
| FAST®                    | OPTOLOGIC®                          | SuperSOT™-8                         |   |
| FastvCore™               | OPTOPLANAR®                         | SupreMOS®                           |   |
| FETBench™                | ™                                   | SyncFET™                            |   |
| FlashWriter®             | PDP SPM™                            | Sync-Lock™                          |   |
| FPS™                     |                                     |                                     |   |

\* Trademarks of System General Corporation, used under license by Fairchild Semiconductor.

**DISCLAIMER**

FAIRCHILD SEMICONDUCTOR RESERVES THE RIGHT TO MAKE CHANGES WITHOUT FURTHER NOTICE TO ANY PRODUCTS HEREIN TO IMPROVE RELIABILITY, FUNCTION, OR DESIGN. FAIRCHILD DOES NOT ASSUME ANY LIABILITY ARISING OUT OF THE APPLICATION OR USE OF ANY PRODUCT OR CIRCUIT DESCRIBED HEREIN; NEITHER DOES IT CONVEY ANY LICENSE UNDER ITS PATENT RIGHTS, NOR THE RIGHTS OF OTHERS. THESE SPECIFICATIONS DO NOT EXPAND THE TERMS OF FAIRCHILD'S WORLDWIDE TERMS AND CONDITIONS, SPECIFICALLY THE WARRANTY THEREIN, WHICH COVERS THESE PRODUCTS.

**LIFE SUPPORT POLICY**

FAIRCHILD'S PRODUCTS ARE NOT AUTHORIZED FOR USE AS CRITICAL COMPONENTS IN LIFE SUPPORT DEVICES OR SYSTEMS WITHOUT THE EXPRESS WRITTEN APPROVAL OF FAIRCHILD SEMICONDUCTOR CORPORATION.

As used herein:

1. Life support devices or systems are devices or systems which, (a) are intended for surgical implant into the body or (b) support or sustain life, and (c) whose failure to perform when properly used in accordance with instructions for use provided in the labeling, can be reasonably expected to result in a significant injury of the user.
2. A critical component in any component of a life support, device, or system whose failure to perform can be reasonably expected to cause the failure of the life support device or system, or to affect its safety or effectiveness.

**ANTI-COUNTERFEITING POLICY**

Fairchild Semiconductor Corporation's Anti-Counterfeiting Policy. Fairchild's Anti-Counterfeiting Policy is also stated on our external website, [www.fairchildsemi.com](http://www.fairchildsemi.com), under Sales Support.

Counterfeiting of semiconductor parts is a growing problem in the industry. All manufacturers of semiconductor products are experiencing counterfeiting of their parts. Customers who inadvertently purchase counterfeit parts experience many problems such as loss of brand reputation, substandard performance, failed applications, and increased cost of production and manufacturing delays. Fairchild is taking strong measures to protect ourselves and our customers from the proliferation of counterfeit parts. Fairchild strongly encourages customers to purchase Fairchild parts either directly from Fairchild or from Authorized Fairchild Distributors who are listed by country on our web page cited above. Products customers buy either from Fairchild directly or from Authorized Fairchild Distributors are genuine parts, have full traceability, meet Fairchild's quality standards for handling and storage and provide access to Fairchild's full range of up-to-date technical and product information. Fairchild and our Authorized Distributors will stand behind all warranties and will appropriately address any warranty issues that may arise. Fairchild will not provide any warranty coverage or other assistance for parts bought from Unauthorized Sources. Fairchild is committed to combat this global problem and encourage our customers to do their part in stopping this practice by buying direct or from authorized distributors.

**PRODUCT STATUS DEFINITIONS**

**Definition of Terms**

Datasheet Identification	Product Status	Definition
Advance Information	Formative / In Design	Datasheet contains the design specifications for product development. Specifications may change in any manner without notice.
Preliminary	First Production	Datasheet contains preliminary data; supplementary data will be published at a later date. Fairchild Semiconductor reserves the right to make changes at any time without notice to improve design.
No Identification Needed	Full Production	Datasheet contains final specifications. Fairchild Semiconductor reserves the right to make changes at any time without notice to improve the design.
Obsolete	Not In Production	Datasheet contains specifications on a product that is discontinued by Fairchild Semiconductor. The datasheet is for reference information only.

Rev. 149

ON Semiconductor and  are trademarks of Semiconductor Components Industries, LLC dba ON Semiconductor or its subsidiaries in the United States and/or other countries. ON Semiconductor owns the rights to a number of patents, trademarks, copyrights, trade secrets, and other intellectual property. A listing of ON Semiconductor's product/patent coverage may be accessed at [www.onsemi.com/site/pdf/Patent-Marking.pdf](http://www.onsemi.com/site/pdf/Patent-Marking.pdf). ON Semiconductor reserves the right to make changes without further notice to any products herein. ON Semiconductor makes no warranty, representation or guarantee regarding the suitability of its products for any particular purpose, nor does ON Semiconductor assume any liability arising out of the application or use of any product or circuit, and specifically disclaims any and all liability, including without limitation special, consequential or incidental damages. Buyer is responsible for its products and applications using ON Semiconductor products, including compliance with all laws, regulations and safety requirements or standards, regardless of any support or applications information provided by ON Semiconductor. "Typical" parameters which may be provided in ON Semiconductor data sheets and/or specifications can and do vary in different applications and actual performance may vary over time. All operating parameters, including "Typicals" must be validated for each customer application by customer's technical experts. ON Semiconductor does not convey any license under its patent rights nor the rights of others. ON Semiconductor products are not designed, intended, or authorized for use as a critical component in life support systems or any FDA Class 3 medical devices or medical devices with a same or similar classification in a foreign jurisdiction or any devices intended for implantation in the human body. Should Buyer purchase or use ON Semiconductor products for any such unintended or unauthorized application, Buyer shall indemnify and hold ON Semiconductor and its officers, employees, subsidiaries, affiliates, and distributors harmless against all claims, costs, damages, and expenses, and reasonable attorney fees arising out of, directly or indirectly, any claim of personal injury or death associated with such unintended or unauthorized use, even if such claim alleges that ON Semiconductor was negligent regarding the design or manufacture of the part. ON Semiconductor is an Equal Opportunity/Affirmative Action Employer. This literature is subject to all applicable copyright laws and is not for resale in any manner.

## PUBLICATION ORDERING INFORMATION

### LITERATURE FULFILLMENT:

Literature Distribution Center for ON Semiconductor  
19521 E. 32nd Pkwy, Aurora, Colorado 80011 USA  
**Phone:** 303-675-2175 or 800-344-3860 Toll Free USA/Canada  
**Fax:** 303-675-2176 or 800-344-3867 Toll Free USA/Canada  
**Email:** [orderlit@onsemi.com](mailto:orderlit@onsemi.com)

**N. American Technical Support:** 800-282-9855 Toll Free  
USA/Canada  
**Europe, Middle East and Africa Technical Support:**  
Phone: 421 33 790 2910  
**Japan Customer Focus Center**  
Phone: 81-3-5817-1050

**ON Semiconductor Website:** [www.onsemi.com](http://www.onsemi.com)  
**Order Literature:** <http://www.onsemi.com/orderlit>  
For additional information, please contact your local  
Sales Representative

# Mouser Electronics

Authorized Distributor

Click to View Pricing, Inventory, Delivery & Lifecycle Information:

[onsemi:](#)

[FMS6151L6X](#)