

EMI Suppression Safety Capacitor, Ceramic Disc, Class X1, 760 V_{AC}, Class Y1, 500 V_{AC}



LINKS TO ADDITIONAL RESOURCES



| QUICK REFERENCE DATA | | | | |
|----------------------------|--------|-----|------------------|------------------|
| DESCRIPTION | VALUE | | | |
| Ceramic Class | 1 | | 2 | |
| Ceramic Dielectric | U2J | U2J | Y5S, Y5U, Y5V | Y5S, Y5U, Y5V |
| Voltage (V _{AC}) | 500 | 760 | 500 | 760 |
| Min. Capacitance (pF) | 10 | | 33 | |
| Max. Capacitance (pF) | 22 | | 4700 | |
| Mounting | Radial | | | |

OPERATING TEMPERATURE RANGE

-40 °C to +125 °C

TEMPERATURE CHARACTERISTICS

Class 1: U2J

Class 2: Y5S, Y5U, Y5V

SECTIONAL SPECIFICATIONS

Climatic category (according to EN 60058-1)

Class 1 and class 2: 40 / 125 / 21

COATING

According to UL 94 V-0

Epoxy resin, isolating, flame retardant

Halogen-free available

Reinforced insulation

APPROVALS

IEC 60384-14

UL 60384-14

DIN EN 60384-14

CSA E60384-1:03, CSA E60384-14:09

CQC11-471112-2009

PACKAGING

Bulk, tape and reel, taped ammpack

FEATURES

- Complying with IEC 60384-14
- High reliability
- Vertical (inline) kinked or straight leads
- Singlelayer AC disc safety capacitors
- Material categorization:
for definitions of compliance please see
www.vishay.com/doc?99912



RoHS
COMPLIANT
HALOGEN
FREE
GREEN
(5-2008)

APPLICATIONS

- X1, Y1 according to IEC 60384-14
- Line-to-line filtering (Class X)
- Line-to-ground filtering (Class Y)
- Primary and secondary coupling (SMPS)
- EMI / RFI suppression and filtering

DESIGN

The capacitor consists of a ceramic disc which is silver plated on both sides. Connection leads are made of tinned copper clad steel having a diameter of 0.6 mm.

The capacitors may be supplied with vertical (inline) kinked leads having a lead spacing of 10.0 mm, or 12.5 mm. Encapsulation is made of flame retardant epoxy resin in accordance with UL 94 V-0.

CAPACITANCE RANGE

10 pF to 4700 pF

RATED VOLTAGE U_R

IEC 60384-14:

(X1): 760 V_{AC}, 50 Hz

(Y1): 500 V_{AC}, 50 Hz

1500 V_{DC}

TEST VOLTAGE

Component test (100 %):

4000 V_{AC}, 50 Hz, 2 s

Random sampling test (destructive test):

4000 V_{AC}, 50 Hz, 60 s

Voltage proof of coating (destructive test):

4000 V_{AC}, 50 Hz, 60 s

INSULATION RESISTANCE

≥ 10 000 MΩ

CAPACITANCE TOLERANCE

± 20 % (code M); ± 10 % (code K)

DISSIPATION FACTOR

Class 1: max. 0.5 % (1 MHz)

Class 2: max. 2.5 % (1 kHz)

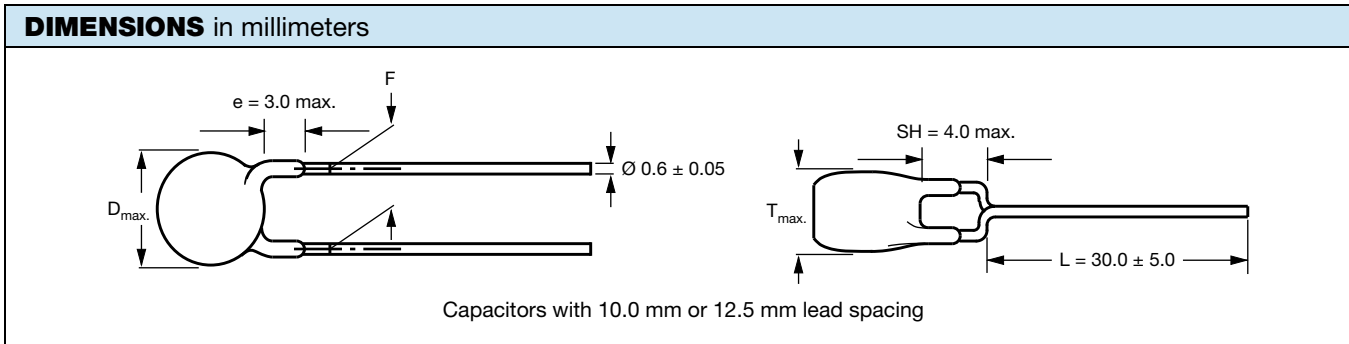

| TECHNICAL DATA | | | | | |
|-----------------------------|---------------------------------|--|---|-------------------------------|---|
| CAPACITANCE C (pF) | CAPACITANCE TOLERANCE (%) | BODY DIAMETER D _{max.} (mm) | BODY THICKNESS T _{max.} (mm) | LEAD SPACING F (mm) ± 1 mm | PART NUMBER |
| | | | | | MISSING DIGITS SEE ORDERING CODE BELOW |
| U2J | | | | | |
| 10 | ± 10 | 8.0 | 5.0 | 10.0 or 12.5 | VY1100K31U2JQ6### |
| 15 | | | | | VY1150K31U2JQ6### |
| 22 | | | | | VY1220K31U2JQ6### |
| Y5S | | | | | |
| 33 | ± 10 | 8.0 | 5.0 | 10.0 or 12.5 | VY1330K31Y5SQ6### |
| 47 | | | | | VY1470K31Y5SQ6### |
| 68 | | | | | VY1680K31Y5SQ6### |
| 100 | | | | | VY1101K31Y5SQ6### |
| 150 | | | | | VY1151K31Y5SQ6### |
| 220 | | | | | VY1221K31Y5SQ6### |
| 330 | | | | | VY1331K31Y5SQ6### |
| Y5U | | | | | |
| 470 | ± 20 ⁽¹⁾ | 8.0 | 5.0 | 10.0 or 12.5 | VY1471#31Y5UQ6### |
| 680 | | | | | VY1681#31Y5UQ6### |
| 1000 | | 9.0 | | | VY1102#35Y5UQ6### |
| 1500 | | 10.5 | | | VY1152#41Y5UQ6### |
| 2200 | | 12.0 | | | VY1222#47Y5UQ6### |
| 3300 | | 15.0 | | | VY1332#59Y5UQ6### |
| 3900 | | 15.5 | | | VY1392#61Y5UQ6### |
| 4700 | | 16.0 | | | VY1472#63Y5UQ6### |
| Y5V MINI SIZE SERIES | | | | | |
| 1000 | ± 20 | 7.5 | 5.5 | 10.0 or 12.5 | VY1102M29Y5VQ6### |
| 1500 | | 8.5 | | | VY1152M33Y5VQ6### |
| 2200 | | 9.5 | | | VY1222M37Y5VQ6### |
| 3300 | | 11.0 | | | VY1332M43Y5VQ6### |
| 3900 | | 12.0 | | | VY1392M47Y5VQ6### |
| 4700 | | 13.0 | | | VY1472M51Y5VQ6### |

Notes

- Straight leads available on request
- Coating extension DR valid for straight leads only

⁽¹⁾ ± 10 % available on request

| ORDERING CODE | | | | | | | | | | |
|----------------|--|-------------------|-----------------------|-----------|-------------------------|------------------------------------|--------------------|---|--------------------------------------|----------------------|
| # | 7 th digit | | Capacitance tolerance | | | ± 10 % = K, ± 20 % = M | | | | |
| ### | 15 th to 17 th digit | | Lead configuration | | | Available configurations see below | | | | |
| Example | VY1 | 101 | K | 31 | Y5S | Q | 6 | T | V | 0 |
| | Series | Capacitance value | Tolerance code | Size code | Temperature coefficient | Rated voltage | Lead wire diameter | Packaging / lead length | Lead style | Lead spacing |
| | | | | | | Q = X1/Y1 500 V (AC) | | 3 = bulk T = tape and reel U = ammpack | L = straight V = inline kinked | 0 = 10.0 X = 12.5 |

| PACKAGING | | | | |
|-----------|---|----------------------|------|------|
| SIZE CODE | BODY DIAMETER D _{max.} (mm) | PACKAGING QUANTITIES | | |
| | | BULK | REEL | AMMO |
| 31 to 47 | 12.0 | 1000 | 500 | 750 |
| 51 to 63 | 16.0 | 500 | 500 | 750 |

Note

- The capacitors are supplied in bulk packaging (cardboard boxes), in tape on reel or in ammpack

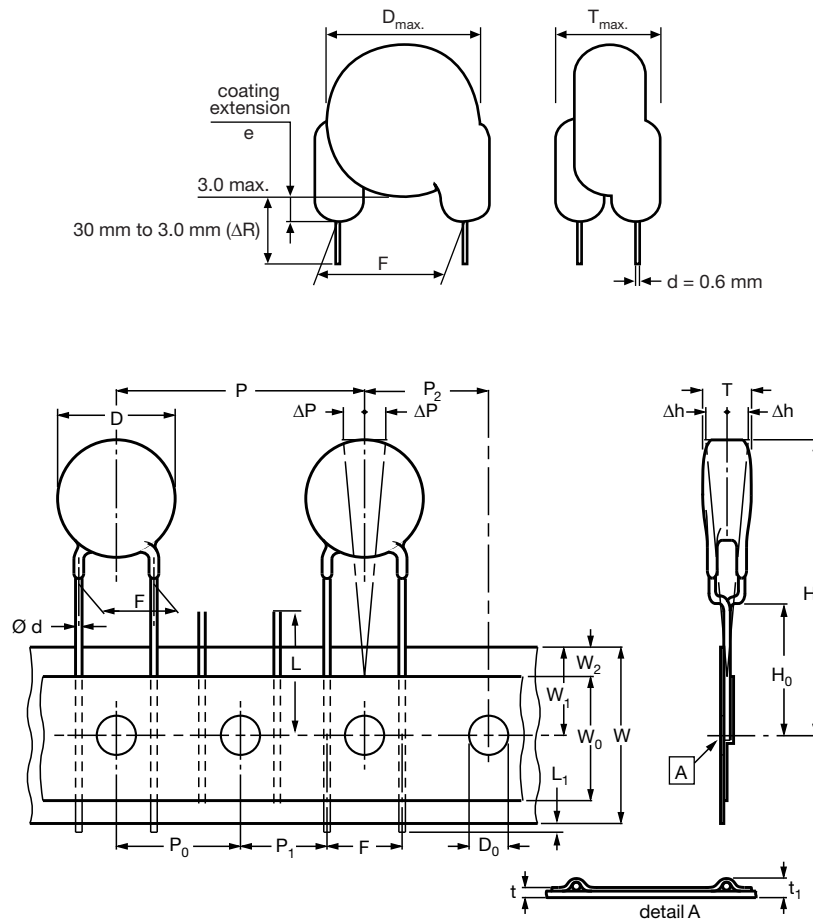
STRAIGHT LEADS

The sprocket hole pitch (P_0) is 12.7 mm for lead spacing 10.0 mm and 12.5 mm

| DIMENSIONS OF TAPE | | |
|-------------------------------|--|--------------------------|
| SYMBOL | PARAMETER | DIMENSIONS (mm) |
| D ⁽¹⁾ | Body diameter | 16.0 max. |
| d | Lead diameter | 0.6 ± 0.05 |
| P | Pitch of component | 25.4 ± 1 |
| P ₀ ⁽²⁾ | Pitch of sprocket hole | 12.7 ± 0.3 |
| P ₁ ⁽³⁾ | Distance, hole center to lead | 7.7 or 6.4 ± 1.0 |
| P ₂ ⁽³⁾ | Distance, hole to center of component | 12.7 ± 1.5 |
| F | Lead spacing | 10.0 or 12.5 + 0.6/- 0.4 |
| Δh | Average deviation across tape | ± 1.0 max. |
| ΔP | Average deviation in direction of reeling | ± 1.0 max. |
| W | Carrier tape width | 18.0 + 1/- 0.5 |
| W ₀ | Hold-down tape width | 5.0 min. |
| W ₁ | Position of sprocket hole | 9.0 + 0.75/- 0.5 |
| W ₂ | Distance of hold-down tape | 3.0 max. |
| H ₁ | Maximum component height | 40.0 |
| H ₀ | Height to seating plane (for kinked leads) | 16.0 ± 0.5 |
| H ₀ | Height to seating plane (for straight leads) | 20.0 ± 0.5 |
| L | Length of cut leads | 11.0 max. |
| L ₁ | Length of lead protrusion | 1.0 max. |
| D ₀ | Diameter of sprocket hole | 4.0 ± 0.2 |
| t | Total tape thickness | 0.9 max. |
| t ₁ | Total tape thickness with lead wire | t + d |

Notes

- (1) See "Technical Data" table
- (2) Cumulative pitch error: ± 1 mm/20 pitches
- (3) Obliquity maximum 3°

REEL AND TAPE DATA in millimeters

Reel with capacitors on tape



Ammpack with capacitors on tape

APPROVALS

IEC 60384-14 - Safety tests
 This approval together with CB test certificate substitutes all national approvals.

CB Certificate

| | | | | |
|------------------------------------|-------------|-----------------|---------------------|--|
| Y1-capacitor: CB test certificate: | US-26561-UL | 10 pF to 4.7 nF | 500 V _{AC} | |
| X1-capacitor: CB test certificate: | US-26561-UL | 10 pF to 4.7 nF | 760 V _{AC} | |

VDE

| | | | | |
|-----------------------------------|----------|-----------------|---------------------|--|
| Y1-capacitor: VDE marks approval: | 40012673 | 10 pF to 4.7 nF | 500 V _{AC} | |
| X1-capacitor: VDE marks approval: | 40012673 | 10 pF to 4.7 nF | 760 V _{AC} | |

DIN EN 60384-14 VDE 0565-1-1:2006-04 - Safety tests

Underwriters Laboratories Inc./Canadian Standards Association

| | | | | |
|-------------------------------------|---------|-----------------|---------------------|--|
| Y1-capacitor: CSA test certificate: | E183844 | 10 pF to 4.7 nF | 500 V _{AC} | |
| X1-capacitor: CSA test certificate: | E183844 | 10 pF to 4.7 nF | 760 V _{AC} | |

UL 60384-14, CSA E60384-1:03, CSA E60384-14:09

Fixed capacitors for electromagnetic interference suppression and connection to the supply mains.

CQC

| | | | | |
|-------------------------------------|----------------|-----------------|---------------------|--|
| Y1-capacitor: CQC test certificate: | CQC05001015032 | 10 pF to 4.7 nF | 500 V _{AC} | |
| X1-capacitor: CQC test certificate: | CQC05001015032 | 10 pF to 4.7 nF | 760 V _{AC} | |

MARKING

Sample
(2 sides)

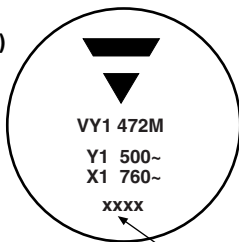

4 digit date code
(year/week; add suffix "V" for mini size series)

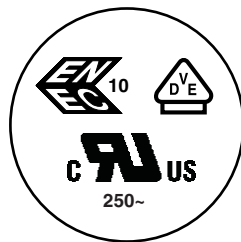

| | | |
|-----------------------|--------------------|-----------|
| PN: VY1471M31Y5UQ6XT0 | Lot1: 14Z551S12 | DC1: 0601 |
| QTY: 225 | Lot2: | DC2: |
| PO: | Batch: 200601CN | |
| SO: | Region: 9520 | SL: 0010 |
| | Ser.No: 0601H69340 | |

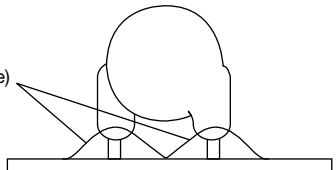

1/1

| PERFORMANCE | | |
|----------------------------------|---|---|
| TEST | TEST CONDITION | TEST LIMITS |
| Visual and mechanical inspection | Optical inspection, dimensions measured with caliper | No visible damage, marking legible |
| Capacitance (C) | 25 °C ± 3 °C , relative humidity (RH) ≤ 75 % , 1.0 V _{RMS} ± 0.2 V _{RMS} at 1 kHz for Y5U and Y5S, and 1 MHz for U2J | Capacitance within specified tolerance |
| Dissipation factor (DF) | | DF ≤ 0.3 % for U2J and DF ≤ 2.5 % for Y5S and Y5U |
| Insulation resistance (IR) | Measured within 60 s ± 5 s after charging at 500 V _{DC} | 10 000 MΩ min. |
| Dielectric strength | 4000 V _{AC} at 50 Hz/60 Hz for 1 min, 50 mA max. | No failure |
| Temperature characteristic | RH ≤ 75 % , 1.0 V _{RMS} ± 0.2 V _{RMS} at 1 kHz for Y5U and Y5S, and 1 MHz for U2J | U2J: -750 ppm ± 120 ppm Y5S: ± 22 % Y5U: +22 %/-56 % |
| Impulse voltage | 3 pulses of 8 kV | No failure |
| Life test | 1000 h at 125 °C ± 2 °C, 850 V _{AC} /50 Hz; once every hour 1000 V _{AC} for 0.1 s | External appearance: no visible damage ΔC/C ≤ ± 15 % DF ≤ 0.5 % for U2J and ≤ 5 % for Y5S and Y5U IR ≥ 3000 MΩ Dielectric strength: no failure |
| Humidity test | 500 h at 500 V _{AC} , 50 Hz and 500 h unloaded 40 °C, RH = 90 % to 95% | External appearance: no visible damage ΔC/C ≤ ± 10 % for U2J and ≤ ± 15 % for Y5S and Y5U DF ≤ 0.5 % for U2J and ≤ 5 % for Y5S and Y5U IR ≥ 3000 MΩ Dielectric strength: no failure |
| Robustness of termination | Pull test: 0.5 kg tensile weight in radial direction for 10 s ± 1 s Bending strength: capacitor body rotated by 90° in both directions | No damage to capacitor body and lead wire |
| Soldering effect | Immersion of lead wires into 260 °C ± 5 °C solder for 10 s ± 2 s; min. distance from body: 1.5 mm Hand soldering at 400 °C ± 10 °C for 3 s to 4 s; min. distance from body: 1.5 mm | External appearance: no visible damage ΔC/C ≤ ± 5 % for U2J and ≤ ± 10 % for Y5S and Y5U Dielectric strength: no failure |
| Vibration test |  <p>Solder the capacitor onto test jig (glass epoxy body) and use resin (adhesive) to stick the body to the test jig. The capacitor must be soldered firmly to the supporting lead wire. Vibration change from 10 Hz to 2000 Hz and back to 10 Hz; Total amplitude: 1.5 mm; Acceleration: 100 m/s²; Sweep rate: 1 oct/min, each axis 2 h (6 h in total)</p> | External appearance: no visible damage Capacitance within specified tolerance DF ≤ 0.3 % for U2J and ≤ 2.5 % for Y5S and Y5U IR ≥ 10 000 GΩ |

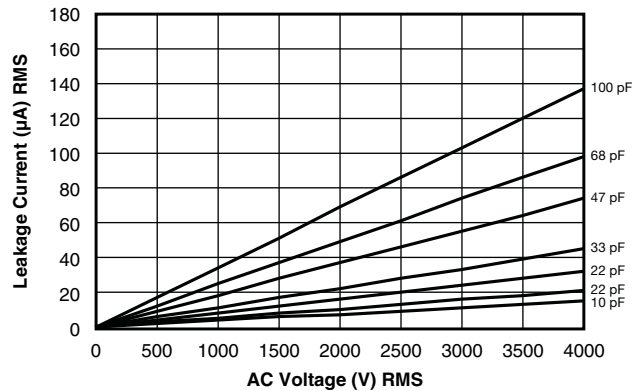
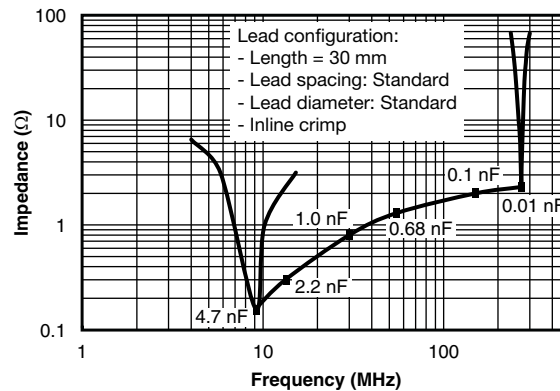
LEAKAGE CURRENT VS. VOLTAGE (Typical)

IMPEDANCE VS. FREQUENCY (Typical)

Note

- The capacitors meet the essential requirements of "EIA 198". Unless stated otherwise all electrical values apply at an ambient temperature of $25\text{ °C} \pm 3\text{ °C}$, at normal atmospheric conditions

| RELATED DOCUMENTS | |
|--------------------------|--|
| General Information | www.vishay.com/doc?28536 |
| CB Test Certificate | www.vishay.com/doc?22249 |
| VDE Marks Approval | www.vishay.com/doc?22251 |
| UL Test Certificate | www.vishay.com/doc?22250 |
| CQC Test Certificate | www.vishay.com/doc?22248 |
| LTspice® Models | www.vishay.com/doc?28568 |

| SAMPLE KITS | |
|------------------------------------|--|
| Part Number (VY1 Sample Kit) | VY11-KIT-HF |
| Link (VY1 Sample Kit) | www.vishay.com/doc?28552 |
| Part Number (VY1...Y5V Sample Kit) | VY1-KIT-MS |
| Link (VY1...Y5V Sample Kit) | www.vishay.com/doc?28561 |



Disclaimer

ALL PRODUCT, PRODUCT SPECIFICATIONS AND DATA ARE SUBJECT TO CHANGE WITHOUT NOTICE TO IMPROVE RELIABILITY, FUNCTION OR DESIGN OR OTHERWISE.

Vishay Intertechnology, Inc., its affiliates, agents, and employees, and all persons acting on its or their behalf (collectively, "Vishay"), disclaim any and all liability for any errors, inaccuracies or incompleteness contained in any datasheet or in any other disclosure relating to any product.

Vishay makes no warranty, representation or guarantee regarding the suitability of the products for any particular purpose or the continuing production of any product. To the maximum extent permitted by applicable law, Vishay disclaims (i) any and all liability arising out of the application or use of any product, (ii) any and all liability, including without limitation special, consequential or incidental damages, and (iii) any and all implied warranties, including warranties of fitness for particular purpose, non-infringement and merchantability.

Statements regarding the suitability of products for certain types of applications are based on Vishay's knowledge of typical requirements that are often placed on Vishay products in generic applications. Such statements are not binding statements about the suitability of products for a particular application. It is the customer's responsibility to validate that a particular product with the properties described in the product specification is suitable for use in a particular application. Parameters provided in datasheets and / or specifications may vary in different applications and performance may vary over time. All operating parameters, including typical parameters, must be validated for each customer application by the customer's technical experts. Product specifications do not expand or otherwise modify Vishay's terms and conditions of purchase, including but not limited to the warranty expressed therein.

Hyperlinks included in this datasheet may direct users to third-party websites. These links are provided as a convenience and for informational purposes only. Inclusion of these hyperlinks does not constitute an endorsement or an approval by Vishay of any of the products, services or opinions of the corporation, organization or individual associated with the third-party website. Vishay disclaims any and all liability and bears no responsibility for the accuracy, legality or content of the third-party website or for that of subsequent links.

Except as expressly indicated in writing, Vishay products are not designed for use in medical, life-saving, or life-sustaining applications or for any other application in which the failure of the Vishay product could result in personal injury or death. Customers using or selling Vishay products not expressly indicated for use in such applications do so at their own risk. Please contact authorized Vishay personnel to obtain written terms and conditions regarding products designed for such applications.

No license, express or implied, by estoppel or otherwise, to any intellectual property rights is granted by this document or by any conduct of Vishay. Product names and markings noted herein may be trademarks of their respective owners.