

SOT-23 Plastic-Encapsulate Diodes

BAP64-04,05,06 Pin Diode

FEATURES

- High voltage ,current controlled
- RF resistor for RF attenuators and switches
- Low diode capacitance
- Low diode forward resistance
- Low series inductance
- For applications up to 3 GHz

SOT-23

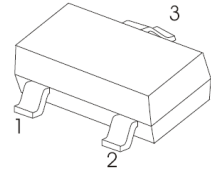

BAP64-04

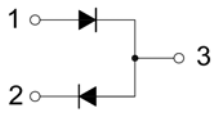

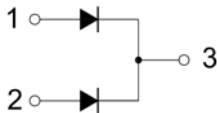

BAP64-05

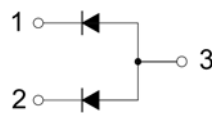

BAP64-06

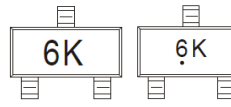

BAP64-04	BAP64-05	BAP64-06
		

Solid dot = Green molding compound device,if none, the normal device.

Maximum Ratings ($T_a=25^{\circ}\text{C}$ unless otherwise specified)

Parameter	Symbol	Value	Unit
Continuous reverse voltage	V_R	175	V
Continuous forward current	I_F	100	mA
Power dissipation	P_D	250	mW
Thermal resistance from junction to ambient	$R_{\theta JA}$	500	$^{\circ}\text{C}/\text{W}$
Junction temperature	T_j	150	$^{\circ}\text{C}$
Storage temperature	T_{stg}	-55~150	$^{\circ}\text{C}$

MOSFET ELECTRICAL CHARACTERISTICS

$T_a=25\text{ }^\circ\text{C}$ unless otherwise specified

Parameter	Symbol	Min	Typ	Max	Unit	Conditions
Forward Voltage	V_F			1.1	V	$I_F=50\text{mA}$
Reverse Current	I_{R1}			10	μA	$V_{R1}=175\text{V}$
	I_{R2}			1		$V_{R2}=20\text{V}$
Diode Capacitance	C_{d1}		0.52		pF	$V_R=0\text{V}, f=1\text{MHz}$
	C_{d2}			0.5		$V_R=1\text{V}, f=1\text{MHz}$
	C_{d3}			0.35		$V_R=20\text{V}, f=1\text{MHz}$
Diode Forward Resistance (note 1)	R_{d1}			40	Ω	$I_F=0.5\text{mA}, f=100\text{MHz}$
	R_{d2}			20		$I_F=1\text{mA}, f=100\text{MHz}$
	R_{d3}			3.8		$I_F=10\text{mA}, f=100\text{MHz}$
	R_{d4}			1.35		$I_F=100\text{mA}, f=100\text{MHz}$
Charge Carrier Life Time	τ_L		1.55		μs	When switched from $I_F=10\text{mA}$ to $I_R=6\text{mA}; R_L=100\Omega$; measured at $I_R=3\text{mA}$
Series Inductance	L_S		1.4		nH	$I_F=10\text{mA}, f=100\text{MHz}$

Note:

1. Guaranteed on AQL basis: inspection level S4, AQL 1.0.

Typical Characteristics

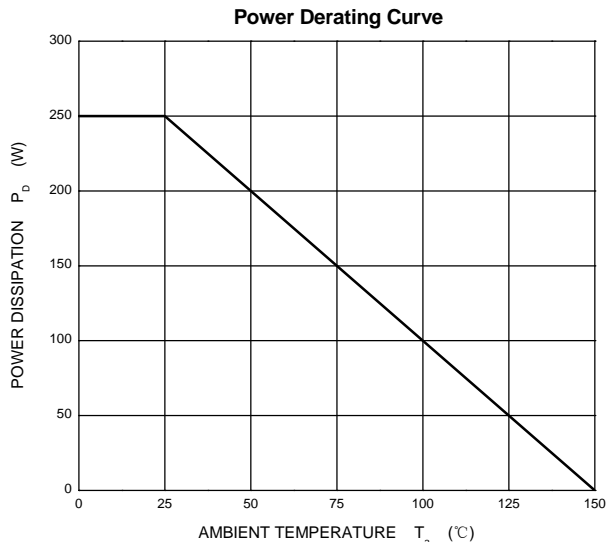
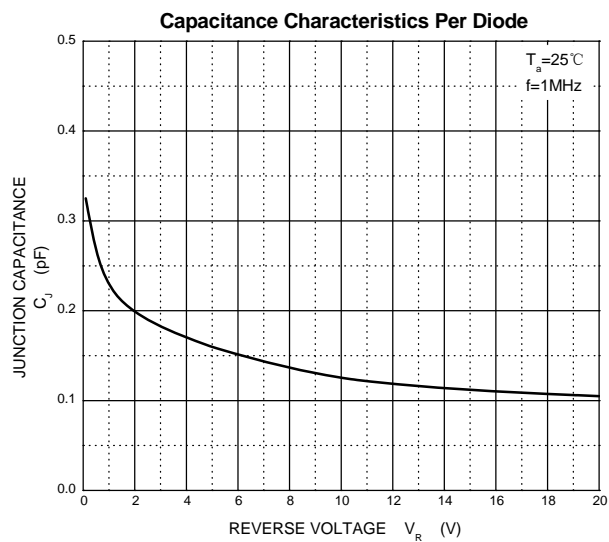
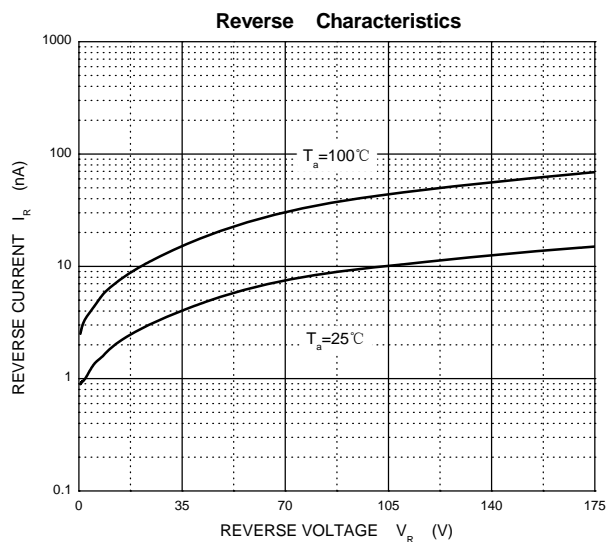
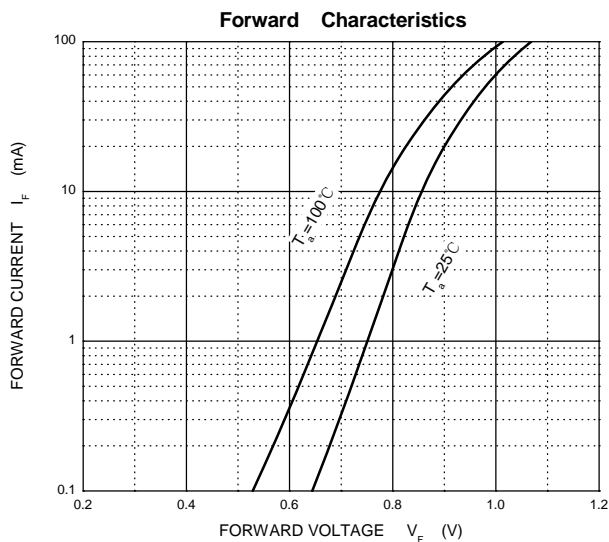

SOT-23 Package Outline Dimensions



Symbol	Dimensions In Millimeters		Dimensions In Inches	
	Min	Max	Min	Max
A	0.900	1.150	0.035	0.045
A1	0.000	0.100	0.000	0.004
A2	0.900	1.050	0.035	0.041
b	0.300	0.500	0.012	0.020
c	0.080	0.150	0.003	0.006
D	2.800	3.000	0.110	0.118
E	1.200	1.400	0.047	0.055
E1	2.250	2.550	0.089	0.100
e	0.950 TYP		0.037 TYP	
e1	1.800	2.000	0.071	0.079
L	0.550 REF		0.022 REF	
L1	0.300	0.500	0.012	0.020
θ	0°	8°	0°	8°

SOT-23 Suggested Pad Layout



- Note:
1. Controlling dimension: in millimeters.
 2. General tolerance: $\pm 0.05\text{mm}$.
 3. The pad layout is for reference purposes only.

NOTICE

JCET reserve the right to make modifications, enhancements, improvements, corrections or other changes without further notice to any product herein. JCET does not assume any liability arising out of the application or use of any product described herein.

SOT-23 Tape and Reel

SOT-23 Embossed Carrier Tape

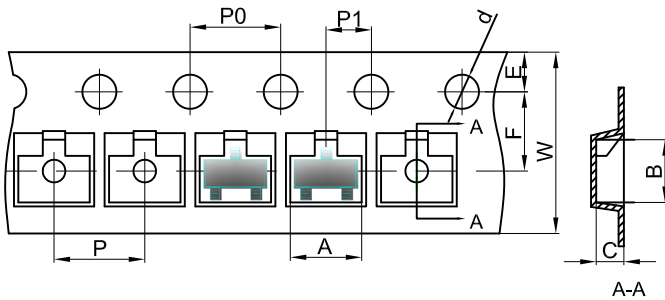

Packaging Description:

SOT-23 parts are shipped in tape. The carrier tape is made from a dissipative (carbon filled) polycarbonate resin. The cover tape is a multilayer film (Heat Activated Adhesive in nature) primarily composed of polyester film, adhesive layer, sealant, and anti-static sprayed agent. These reeled parts in standard option are shipped with 3,000 units per 7" or 17.8cm diameter reel. The reels are clear in color and is made of polystyrene plastic (anti-static coated).

Dimensions are in millimeter

Pkg type	A	B	C	d	E	F	P0	P	P1	W
SOT-23	3.15	2.77	1.22	Ø1.50	1.75	3.50	4.00	4.00	2.00	8.00

SOT-23 Tape Leader and Trailer

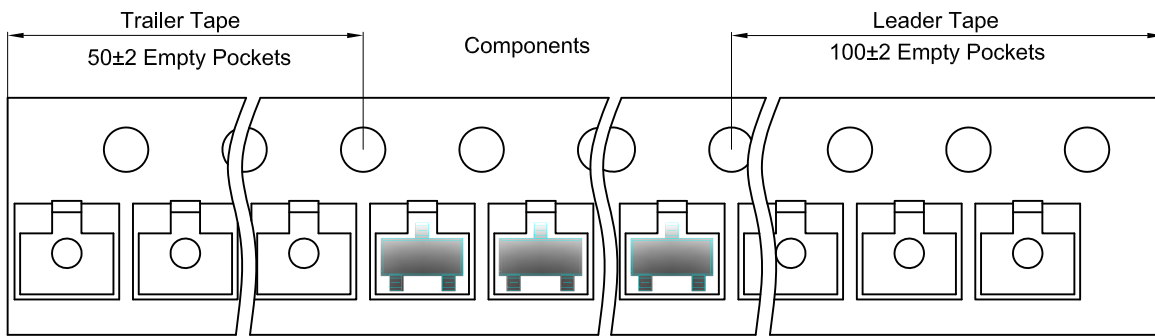

SOT-23 Reel

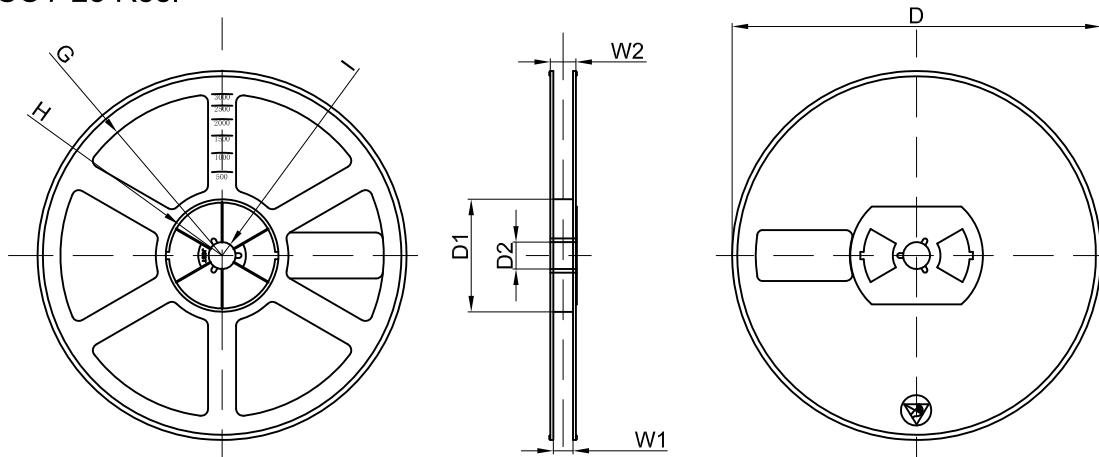

Dimensions are in millimeter

Reel Option	D	D1	D2	G	H	I	W1	W2
7"Dia	Ø178.00	54.40	13.00	R78.00	R25.60	R6.50	9.50	12.30

REEL	Reel Size	Box	Box Size(mm)	Carton	Carton Size(mm)	G.W.(kg)
3000 pcs	7 inch	45,000 pcs	203×203×195	180,000 pcs	438×438×220	