

SOD-123 Plastic-Encapsulate Diodes

BAV19W~BAV21W SWITCHING DIODE

FEATURES

- Low Reverse Current
- Surface Mount Package Ideally Suited for Automatic Insertion
- Fast Switching Speed
- For General Purpose Switching Applications

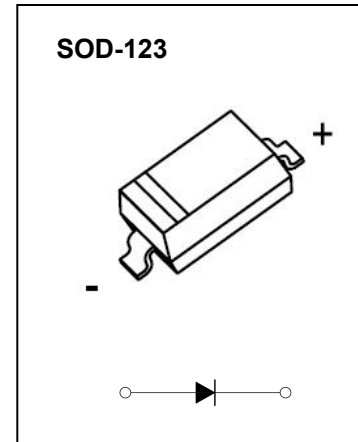

MARKING:

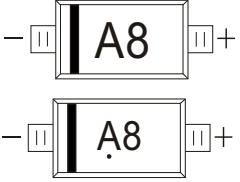
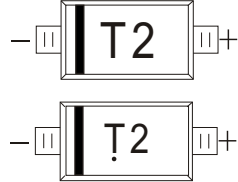
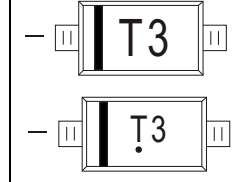
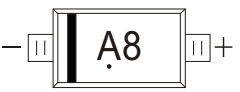
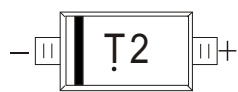
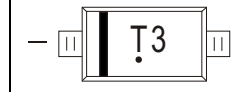
BAV19W A8	BAV20W T2	BAV21W T3
		
		

The marking bar indicates the cathode
Solid dot = Green molding compound device,
if none, the normal device.

MAXIMUM RATINGS ($T_a=25^{\circ}\text{C}$ unless otherwise noted)

Symbol	Parameter	Value			Unit
		BAV19W	BAV20W	BAV21W	
V_{RM}	Non-Repetitive Peak Reverse Voltage	120	200	250	V
V_{RRM}	Peak Repetitive Reverse Voltage	100	150	200	V
V_{RWM}	Working Peak Reverse Voltage				
$V_{R(RMS)}$	RMS Reverse Voltage	71	106	141	V
I_O	Average Rectified Output Current	200			mA
I_{FSM}	Non-repetitive Peak Forward Surge Current @ $t=8.3\text{ms}$	2.0			A
P_D	Power Dissipation	500			mW
$R_{\theta JA}$	Thermal Resistance from Junction to Ambient	250			$^{\circ}\text{C}/\text{W}$
T_j	Junction Temperature	150			$^{\circ}\text{C}$
T_{stg}	Storage Temperature	-55~+150			$^{\circ}\text{C}$

ELECTRICAL CHARACTERISTICS($T_a=25^{\circ}\text{C}$ unless otherwise specified)

Parameter	Symbol	Test conditions	Min	Typ	Max	Unit
Reverse current	I_R	$V_R=100\text{V}$ BAV19W			0.1	μA
		$V_R=150\text{V}$ BAV20W			0.1	
		$V_R=200\text{V}$ BAV21W			0.1	
Forward voltage	V_F	$I_F=100\text{mA}$			1	V
		$I_F=200\text{mA}$			1.25	
Total capacitance	C_{tot}	$V_R=0\text{V}, f=1\text{MHz}$			5	pF
Reverse recovery time	t_{rr}	$I_F=I_R=30\text{mA}, I_{rr}=0.1 \cdot I_R, R_L=100\Omega$			50	ns

BAV19W Typical Characteristics

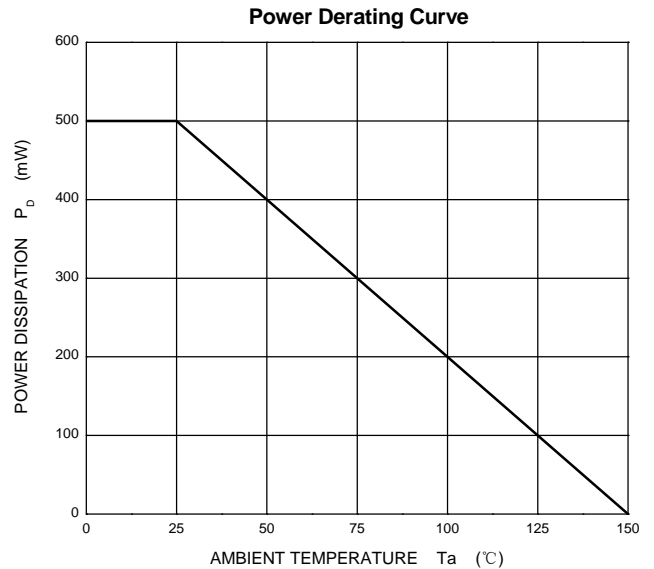
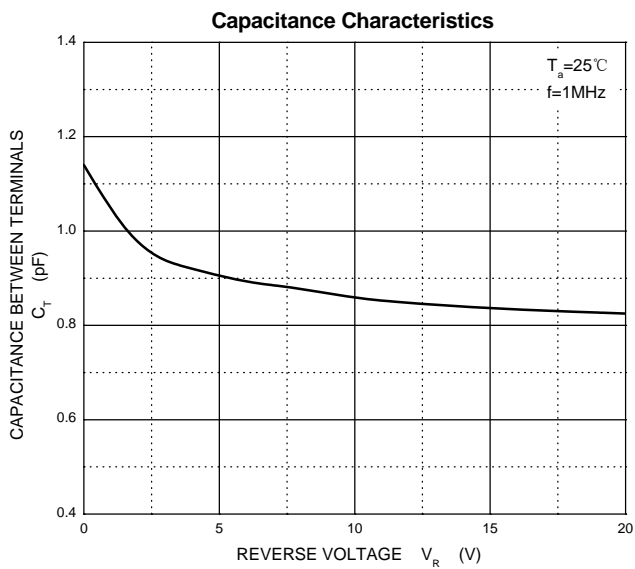
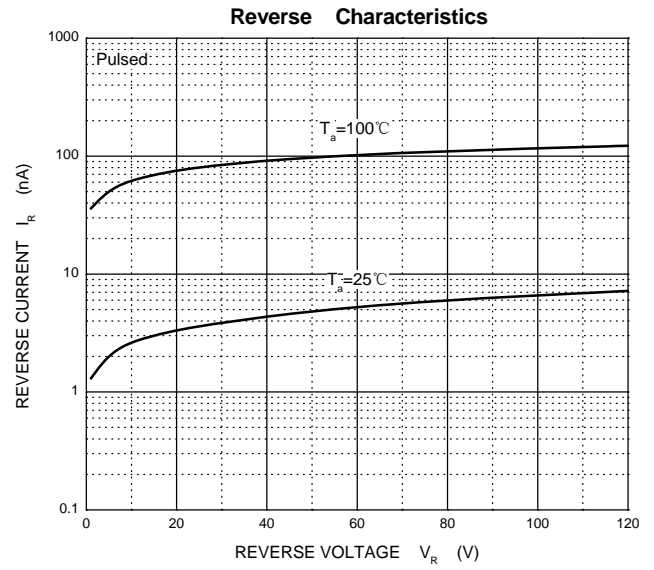
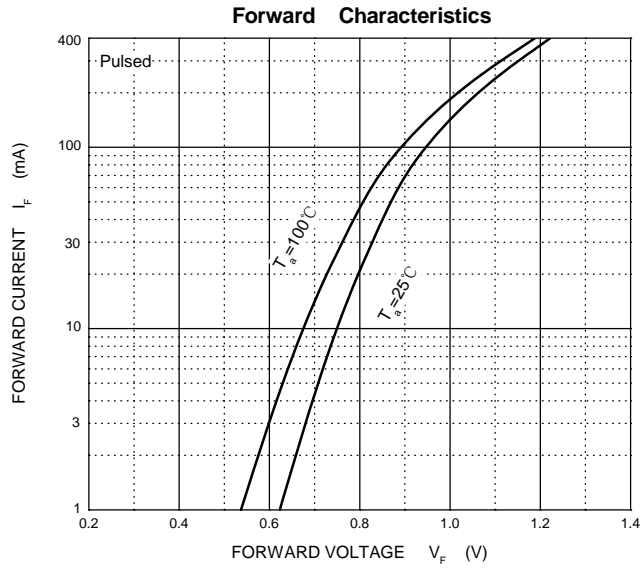

SOD-123 Package Outline Dimensions

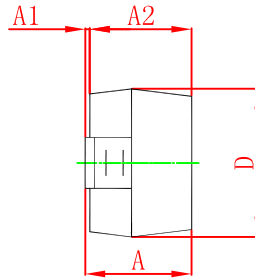
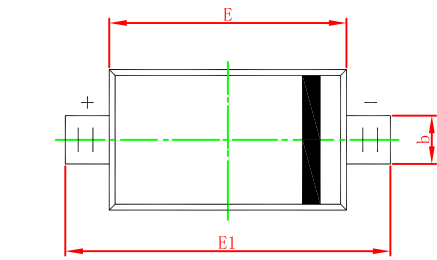

Symbol	Dimensions In Millimeters		Dimensions In Inches	
	Min	Max	Min	Max
A	1.050	1.250	0.041	0.049
A1	0.000	0.100	0.000	0.004
A2	1.050	1.150	0.041	0.045
b	0.450	0.650	0.018	0.026
c	0.080	0.150	0.003	0.006
D	1.500	1.700	0.059	0.067
E	2.600	2.800	0.102	0.110
E1	3.550	3.850	0.140	0.152
L	0.500 REF		0.020 REF	
L1	0.250	0.450	0.010	0.018
θ	0°	8°	0°	8°

SOD-123 Suggested Pad Layout

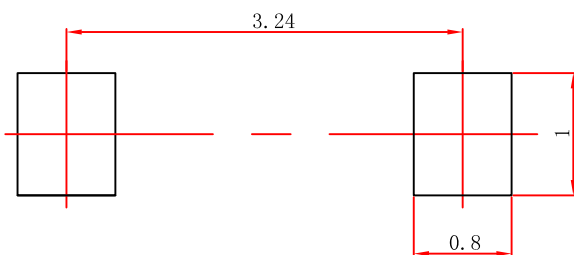

Note:

1. Controlling dimension: in millimeters.
2. General tolerance: $\pm 0.05\text{mm}$.
3. The pad layout is for reference purposes only.

NOTICE

JCET reserve the right to make modifications, enhancements, improvements, corrections or other changes without further notice to any product herein. JCET does not assume any liability arising out of the application or use of any product described herein.

SOD-123 Tape and Reel

SOD-123 Embossed Carrier Tape

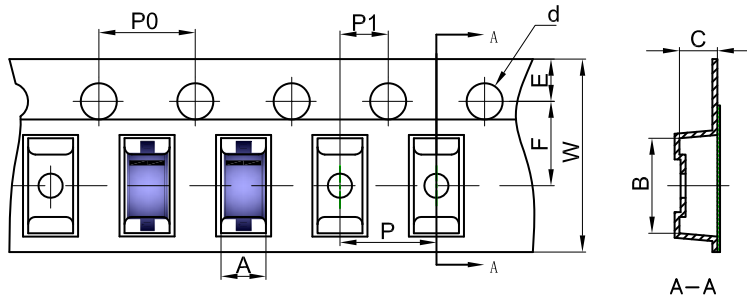

Packaging Description:

SOD-123 parts are shipped in tape. The carrier tape is made from a dissipative (carbon filled) polycarbonate resin. The cover tape is a multilayer film (Heat Activated Adhesive in nature) primarily composed of polyester film, adhesive layer, sealant, and anti-static sprayed agent. These reeled parts in standard option are shipped with 3,000 units per 7" or 17.8cm diameter reel. The reels are clear in color and is made of polystyrene plastic (anti-static coated).

Dimensions are in millimeter											
Pkg type	A	B	C	d	E	F	P0	P	P1	W	
SOD-123	1.85	3.95	1.57	Ø1.55	1.75	3.50	4.00	4.00	2.00	8.00	

SOD-123 Tape Leader and Trailer

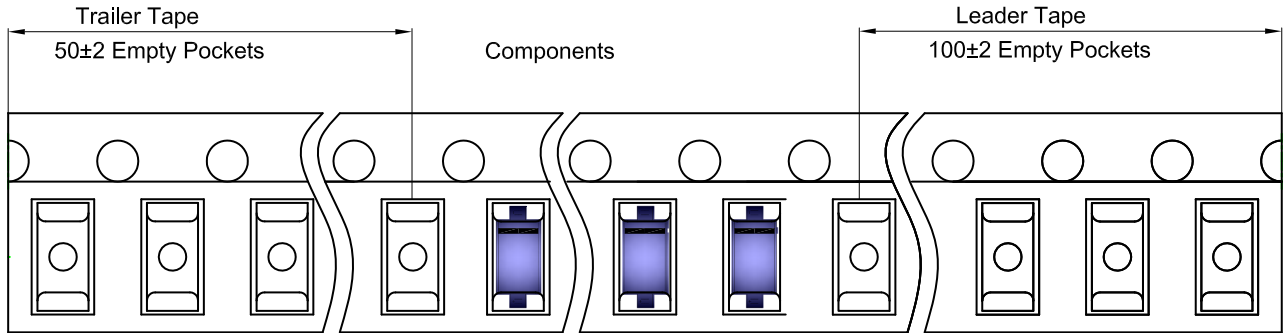

SOD-123 Reel

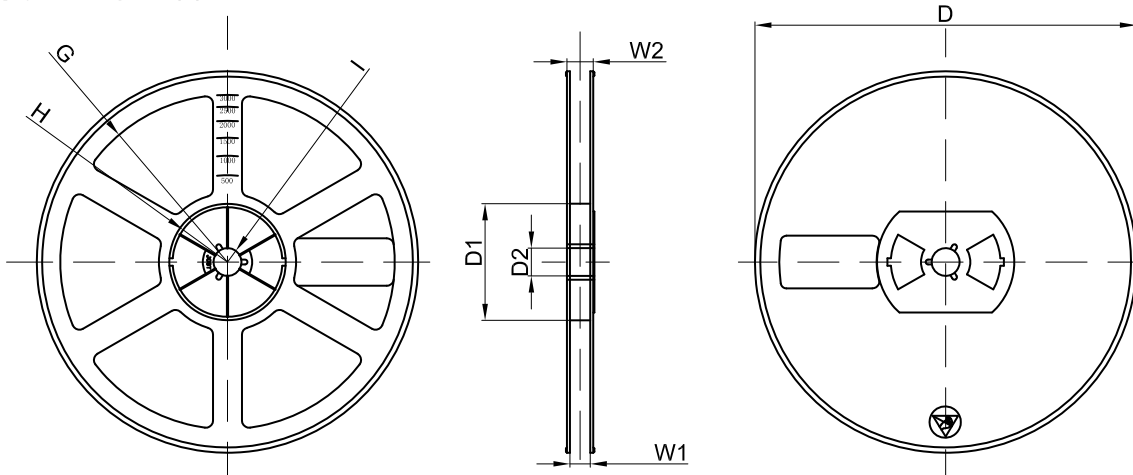

Dimensions are in millimeter								
Reel Option	D	D1	D2	G	H	I	W1	W2
7"Dia	Ø178.00	54.40	13.00	R78.00	R25.60	R6.50	9.50	12.30

REEL	Reel Size	Box	Box Size(mm)	Carton	Carton Size(mm)	G.W.(kg)
3000 pcs	7 inch	45,000 pcs	203×203×195	180,000 pcs	438×438×220	