



Half Pitch Mini-Flat Phototransistor Optocoupler

Features

- High isolation 3750 V_{RMS}
- Multiple CTR selection available
- DC input with transistor output
- Operating temperature range - 55 °C to 125 °C
- RoHS compliance
- REACH compliance
- Halogen compliance
- Regulatory Approvals
 - UL - UL1577 (Pending Approval)
 - VDE - EN60747-5-5 (Pending Approval)
 - CQC – GB4943.1, GB8898 (Pending Approval)
 - IEC60065, IEC60950 (Pending Approval)

Description

The CTH291GB series of general purpose optocoupler consists of a photo transistor optically coupled to a gallium arsenide Infrared-emitting diode in a 4-lead half pitch Mini-Flat package.

Applications

- Switch mode power supplies
- Computer peripheral interface
- Microprocessor system interface

Package Outline

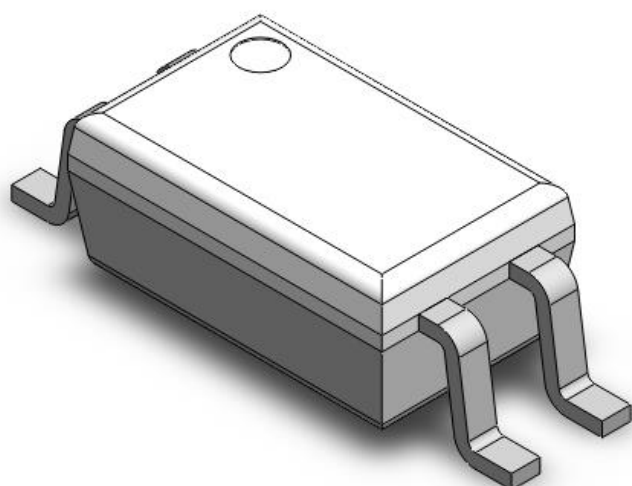

Schematic

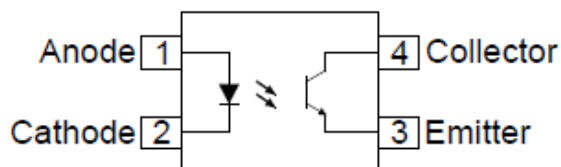

CTH291

**Half Pitch Mini-Flat Phototransistor Optocoupler****Absolute Maximum Rating at 25°C**

Symbol	Parameters	Ratings	Units	Notes
V _{ISO}	Isolation voltage	3750	V _{RMS}	
P _{TOT}	Total power dissipation	200	mW	
T _{OPR}	Operating temperature	-55 ~ +125	°C	
T _{STG}	Storage temperature	-55 ~ +150	°C	
T _{SOL}	Soldering temperature	260	°C	
Emitter				
I _F	Forward current	60	mA	
I _{F(TRANS)}	Peak transient current (≤1μs P.W,300pps)	1000	mA	
V _R	Reverse voltage	6	V	
P _D	Emitter power dissipation	70	mW	
Detector				
P _C	Detector power dissipation	150	mW	
B _{VCEO}	Collector-Emitter Breakdown Voltage	80	V	
B _{VECO}	Emitter-Collector Breakdown Voltage	6	V	
I _C	Collector Current	50	mA	

**Half Pitch Mini-Flat Phototransistor Optocoupler****Electrical Characteristics** $T_A = 25^\circ\text{C}$ (unless otherwise specified)**Emitter Characteristics**

Symbol	Parameters	Test Conditions	Min	Typ	Max	Units	Notes
V_F	Forward voltage	$I_F = 10\text{mA}$	-	1.25	1.4	V	
I_R	Reverse Current	$V_R = 6\text{V}$	-	-	5	μA	
C_{IN}	Input Capacitance	$f = 1\text{MHz}$	-	10	30	pF	

Detector Characteristics

Symbol	Parameters	Test Conditions	Min	Typ	Max	Units	Notes
$B_{V_{CEO}}$	Collector-Emitter Breakdown	$I_C = 100\mu\text{A}$	80	-	-	V	
$B_{V_{ECO}}$	Emitter-Collector Breakdown	$I_E = 100\mu\text{A}$	7	-	-	V	
I_{CEO}	Collector-Emitter Dark Current	$V_{CE} = 48\text{V}, I_F = 0\text{mA}$	-	-	100	nA	
		$V_{CE} = 48\text{V}, T_a = 85^\circ\text{C}$	-	-	50	μA	

Transfer Characteristics

Symbol	Parameters	Test Conditions	Min	Typ	Max	Units	Notes
CTR	Current Transfer Ratio	$I_F = 5\text{mA}, V_{CE} = 5\text{V}$	100	-	400	%	
$V_{CE(SAT)}$	Collector -Emitter Saturation Voltage	$I_F = 1\text{mA}, I_C = 0.2\text{mA}$	-	-	0.4	V	
R_{IO}	Isolation Resistance	$V_{IO} = 500\text{V}_{DC}$	5×10^{10}	-	-	Ω	
C_{IO}	Isolation Capacitance	$f = 1\text{MHz}$	-	0.25	1	pF	

**Half Pitch Mini-Flat Phototransistor Optocoupler**

Switching Characteristics

Symbol	Parameters	Test Conditions	Min	Typ	Max	Units	Notes
t_r	Rise Time	$I_C = 2\text{mA}$, $V_{CE} = 2\text{V}$ $R_L = 100\Omega$	-	5	16	μs	
t_f	Fall Time		-	6	16		
t_{on}	Turn-on time			8	20	μs	
t_{off}	Turn-off time			7	20		



Half Pitch Mini-Flat Phototransistor Optocoupler

Typical Characteristic Curves

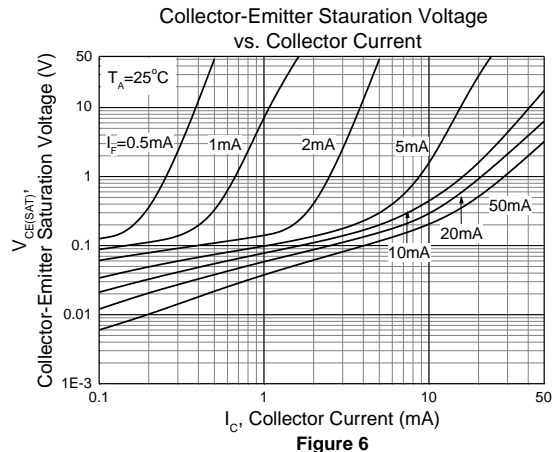
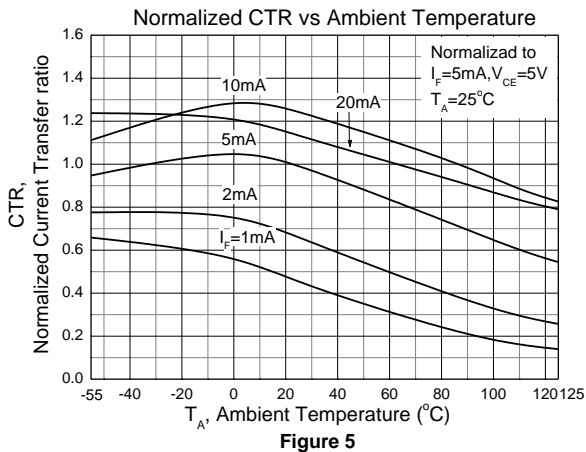
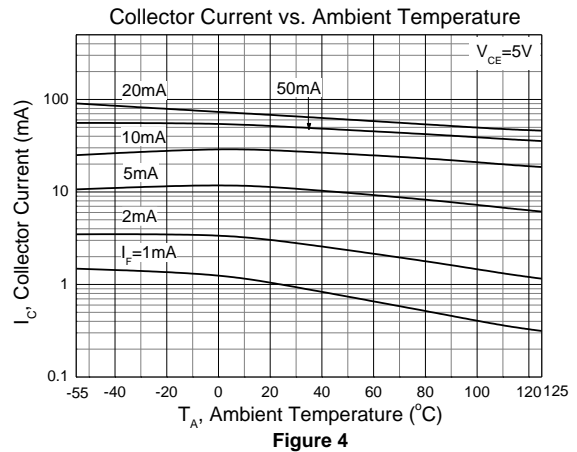
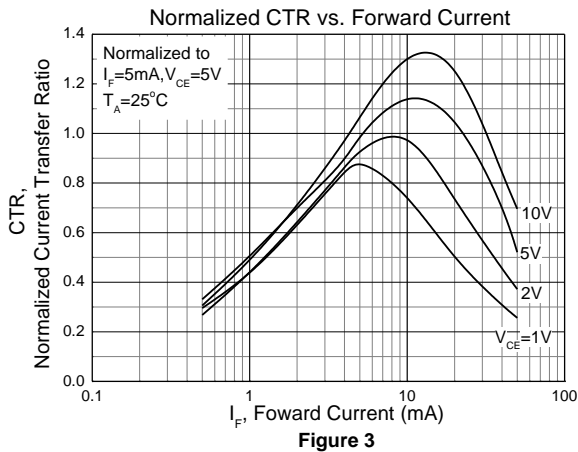
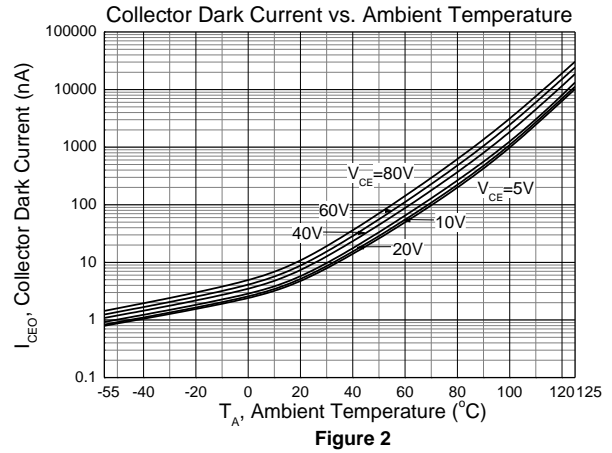
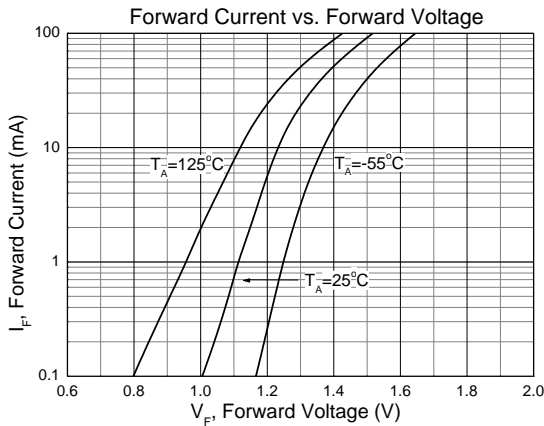



Half Pitch Mini-Flat Phototransistor Optocoupler

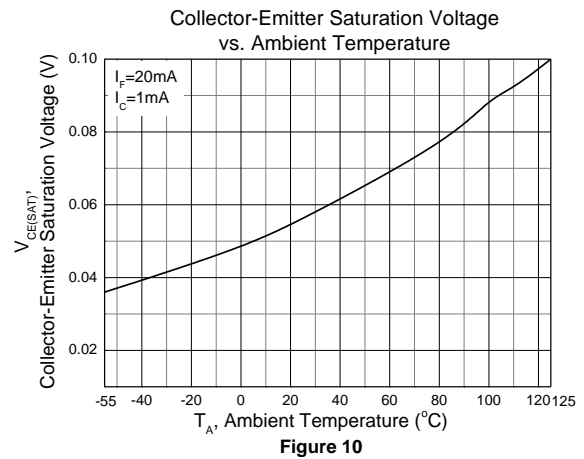
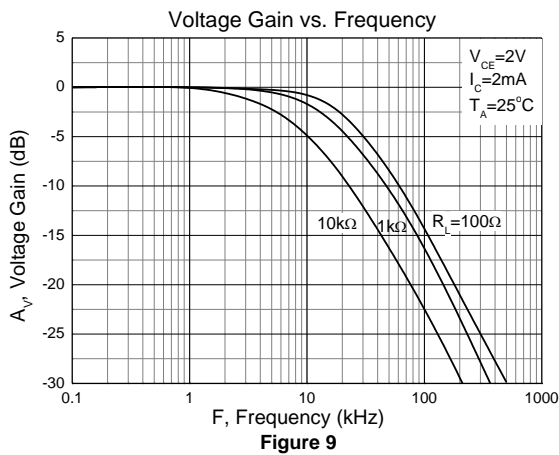
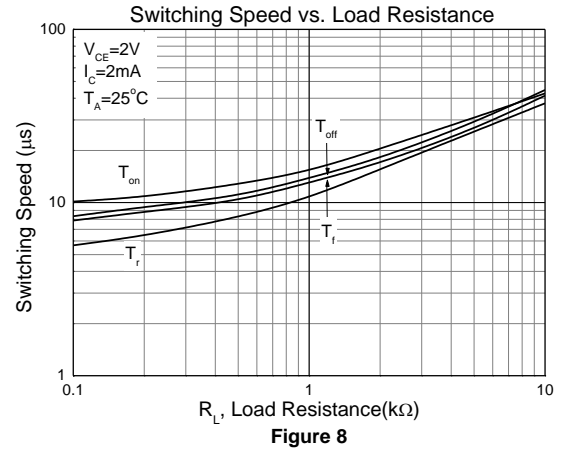
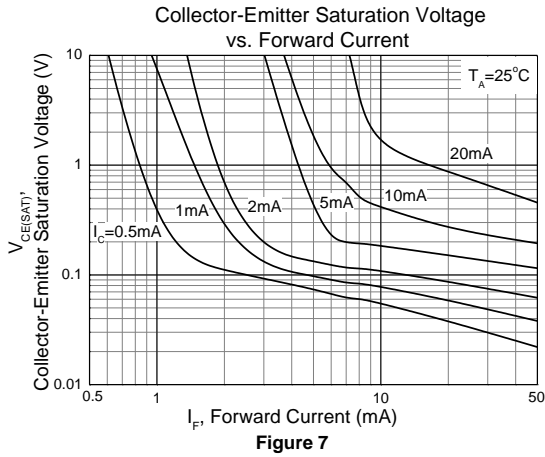



Half Pitch Mini-Flat Phototransistor Optocoupler

Package Dimension *Dimensions in mm unless otherwise stated*

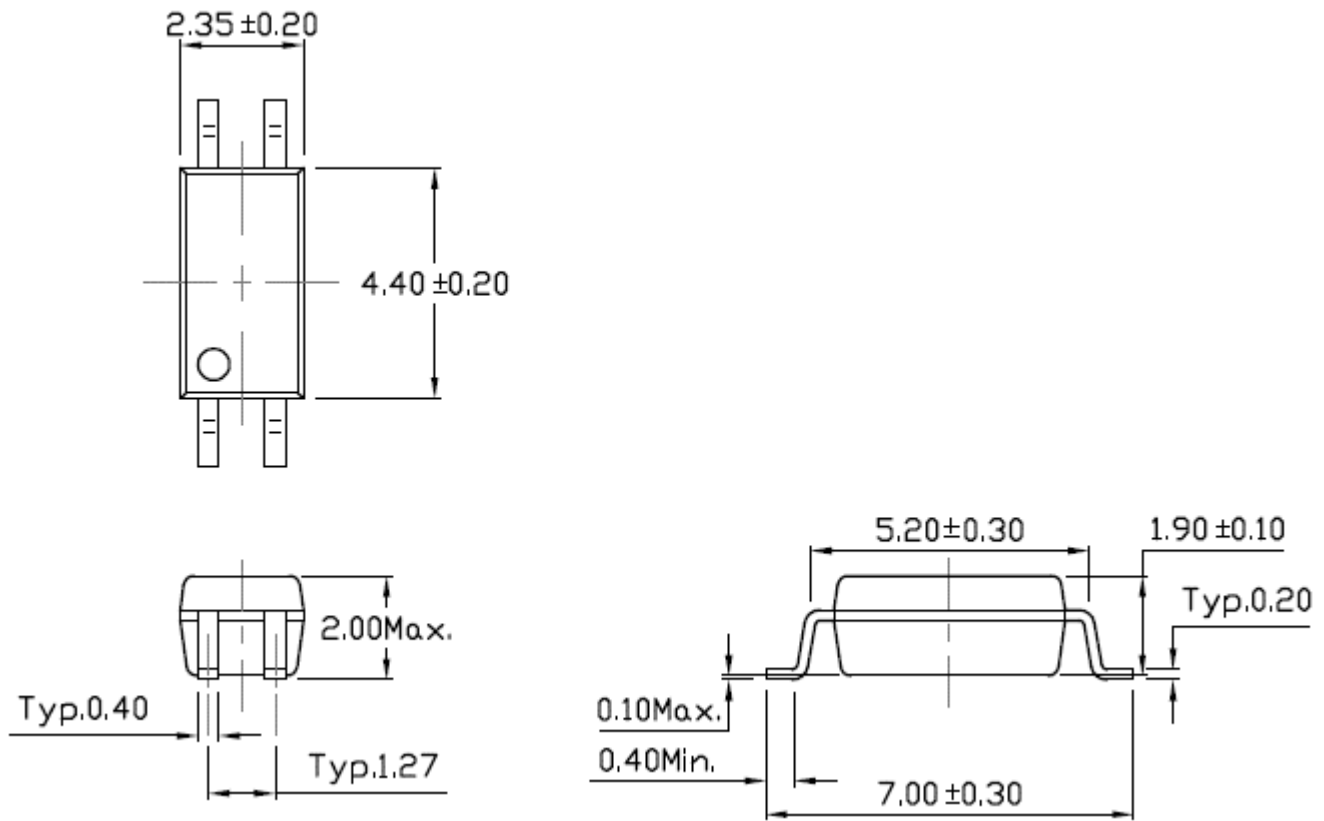

Recommended Solder Mask *Dimensions in mm unless otherwise stated*

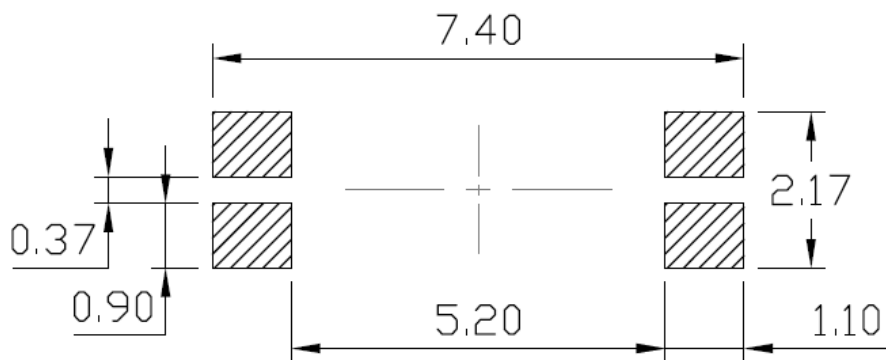



Half Pitch Mini-Flat Phototransistor Optocoupler

Marking Information



Note:

- CT : Denotes “CT Micro”
- 291 : Part Number
- GB : CTR Rank
- V : VDE Safety Option (V or none)
- Y : Fiscal Year
- WW : Work Week
- K : Manufacturing Code

Ordering Information

CTH291GB(V)(Y)

- CT : Denotes “CT Micro”
- 291 : Part Number
- GB : CTR Rank
- V : VDE Safety Option (V or none)
- Y : Tape and reel option (T1 or T2)

Option	Description	Quantity
T1	Surface Mount Lead Forming – With Option 1 Taping	5000 Units/Reel
T2	Surface Mount Lead Forming – With Option 2 Taping	5000 Units/Reel



Half Pitch Mini-Flat Phototransistor Optocoupler

Carrier Tape Specifications *Dimensions in mm unless otherwise stated*

Option T1

Input Direction
→

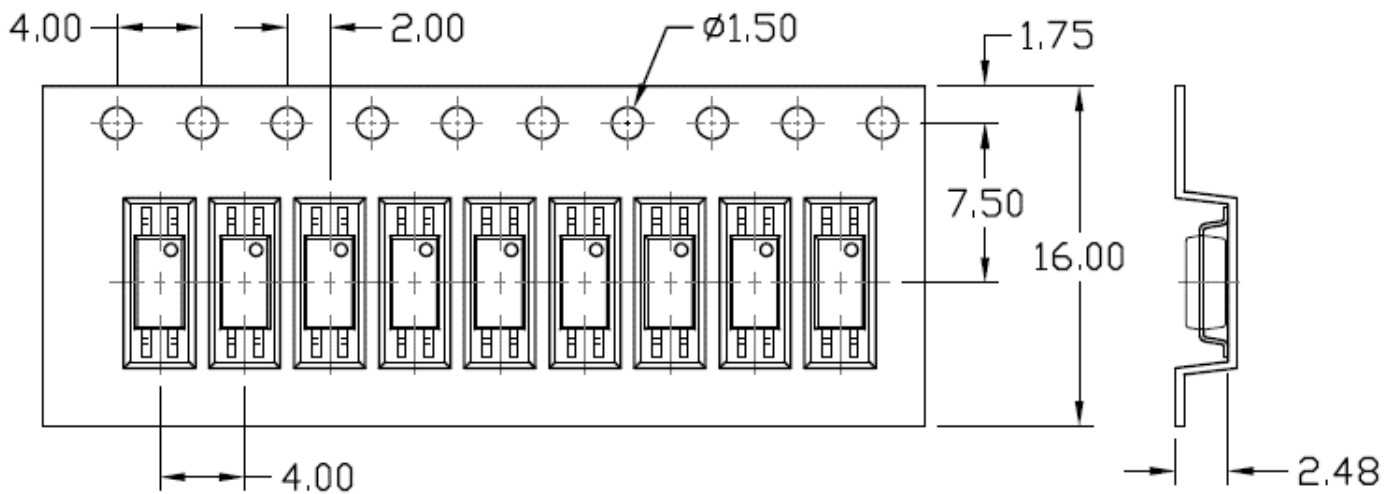

Option T2

Input Direction
→

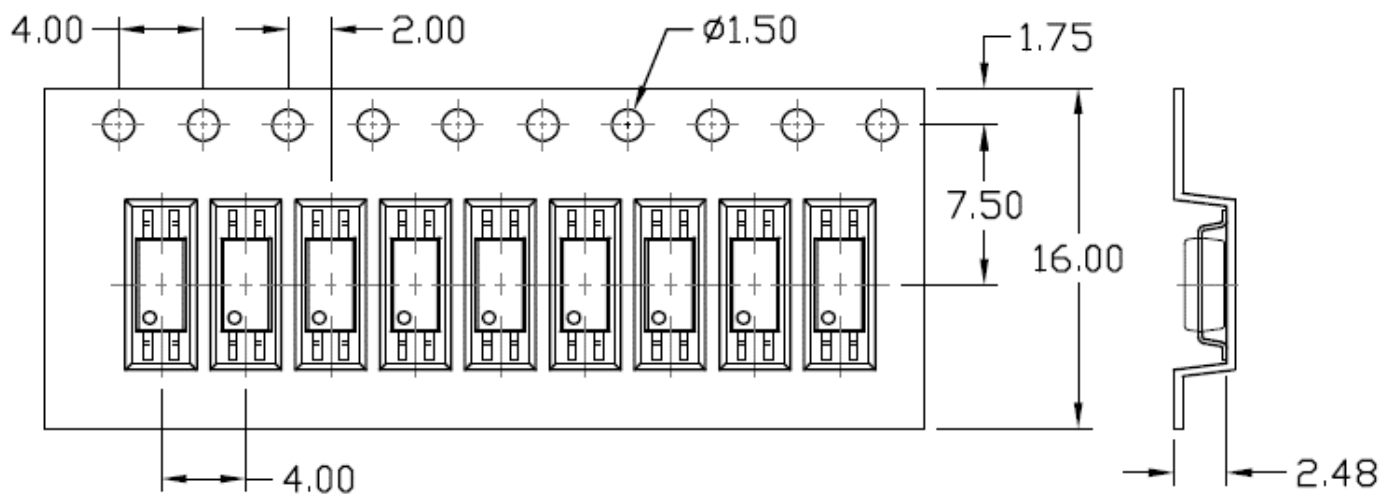



Half Pitch Mini-Flat Phototransistor Optocoupler

Reflow Profile

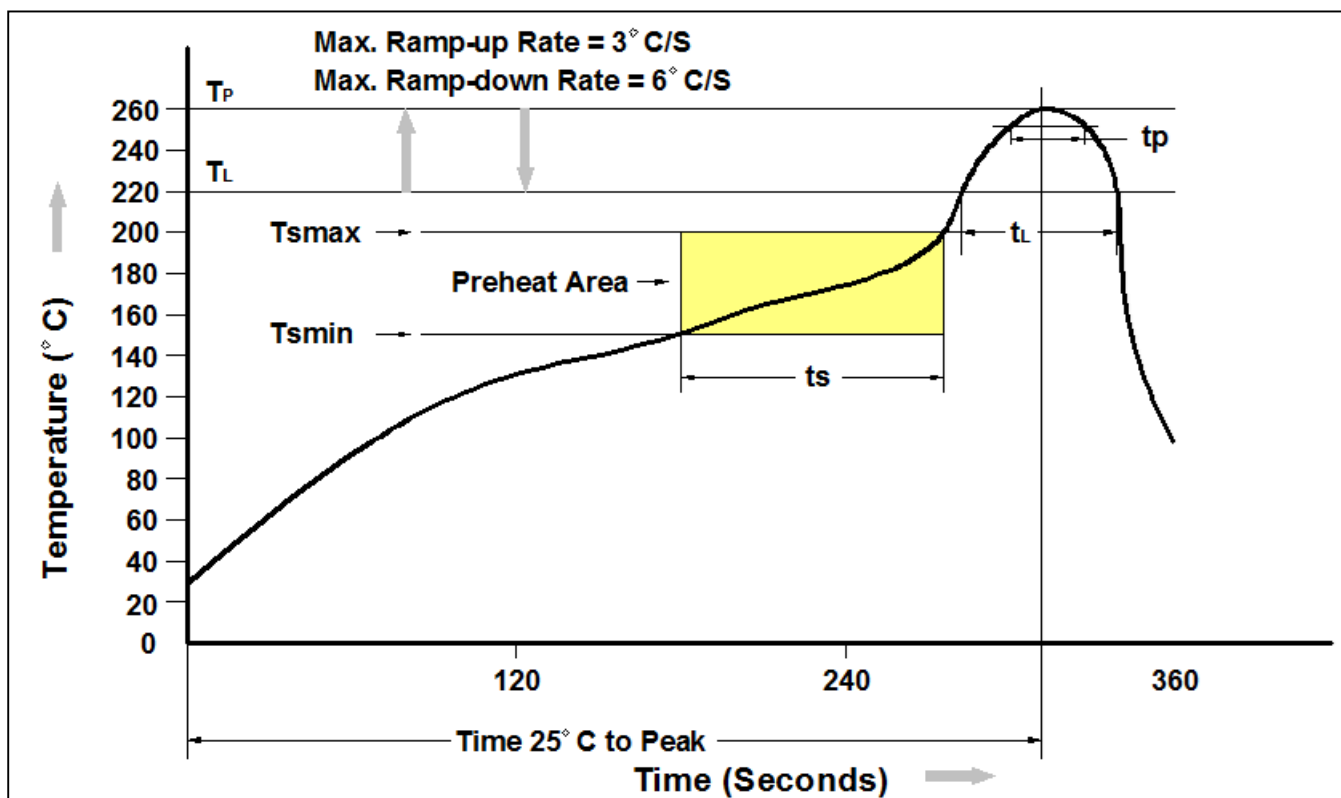

Profile Feature	Pb-Free Assembly Profile
Temperature Min. (T_{smin})	150°C
Temperature Max. (T_{smax})	200°C
Time (t_s) from (T_{smin} to T_{smax})	60-120 seconds
Ramp-up Rate (t_L to t_P)	3°C/second max.
Liquidous Temperature (T_L)	217°C
Time (t_L) Maintained Above (T_L)	60 – 150 seconds
Peak Body Package Temperature	260°C +0°C / -5°C
Time (t_P) within 5°C of 260°C	30 seconds
Ramp-down Rate (T_P to T_L)	6°C/second max
Time 25°C to Peak Temperature	8 minutes max.



Half Pitch Mini-Flat Phototransistor Optocoupler

DISCLAIMER

CTH MICRO RESERVES THE RIGHT TO MAKE CHANGES WITHOUT FURTHER NOTICE TO ANY PRODUCTS HEREIN TO IMPROVE RELIABILITY, FUNCTION OR DESIGN. CTH MICRO DOES NOT ASSUME ANY LIABILITY ARISING OUT OF THE APPLICATION OR USE OF ANY PRODUCT OR CIRCUIT DESCRIBED HEREIN; NEITHER DOES IT CONVEY ANY LICENSE UNDER ITS PATENT RIGHTS, NOR THE RIGHTS OF OTHERS.

DISCOLORATION MIGHT OCCUR ON THE PACKAGE SURFACE AFTER SOLDERING, REFLOW OR LONG TERM USE. THIS DOES NOT IMPACT THE PRODUCT PERFORMANCE NOR THE PRODUCT RELIABILITY.

CTH MICRO ARE NOT AUTHORIZED FOR USE AS CRITICAL COMPONENTS IN LIFE SUPPORT DEVICES OR SYSTEMS WITHOUT EXPRESS WRITTEN APPROVAL OF CTH MICRO INTERNATIONAL CORPORATION.

- 1. Life support devices or systems are devices or systems which, (a) are intended for surgical implant into the body, or (b) support or sustain life, or (c) whose failure to perform when properly used in accordance with instruction for use provided in the labelling, can be reasonably expected to result in significant injury to the user.*
- 2. A critical component is any component of a life support device or system whose failure to perform can be reasonably expected to cause the failure of the life support device or system, or to affect its safety or effectiveness.*