



Technical Data Sheet

Infrared Remote-control Receiver Module

IRM-3638TF4

Features

- Photo detector and preamplifier in one package
- Internal filter for PCM frequency
- Improved inner shielding against electrical field disturbance
- TTL and CMOS compatibility
- Low power consumption
- Improved immunity against ambient light
- Suitable burst length ≥ 10 cycles/burst
- Pb free
- BiCMOS manufacture IC ; ESD HBM>4000V ; MM>250V
- The product itself will remain within RoHS compliant version.



Descriptions

The IRM-3638TF4 is miniaturized receivers for infrared remote control Systems. PIN diode and preamplifier are assembled on lead frame, the epoxy package is designed as IR filter. The demodulated output signal can directly be decoded by a microprocessor.

IRM-3638TF4 is the standard IR remote control receiver series, supporting all major transmission codes.

Applications

- Light detecting portion of remote control
- AV instruments such as Audio, TV, VCR, CD, MD, etc.
- Home appliances such as Air-conditioner, Fan , etc.
- The other equipments with wireless remote control.
- CATV set top boxes
- Multi-media Equipment

PART	MATERIAL	COLOR
Chip	Silicon	Black
Compound	Epoxy	Black

Package Dimensions

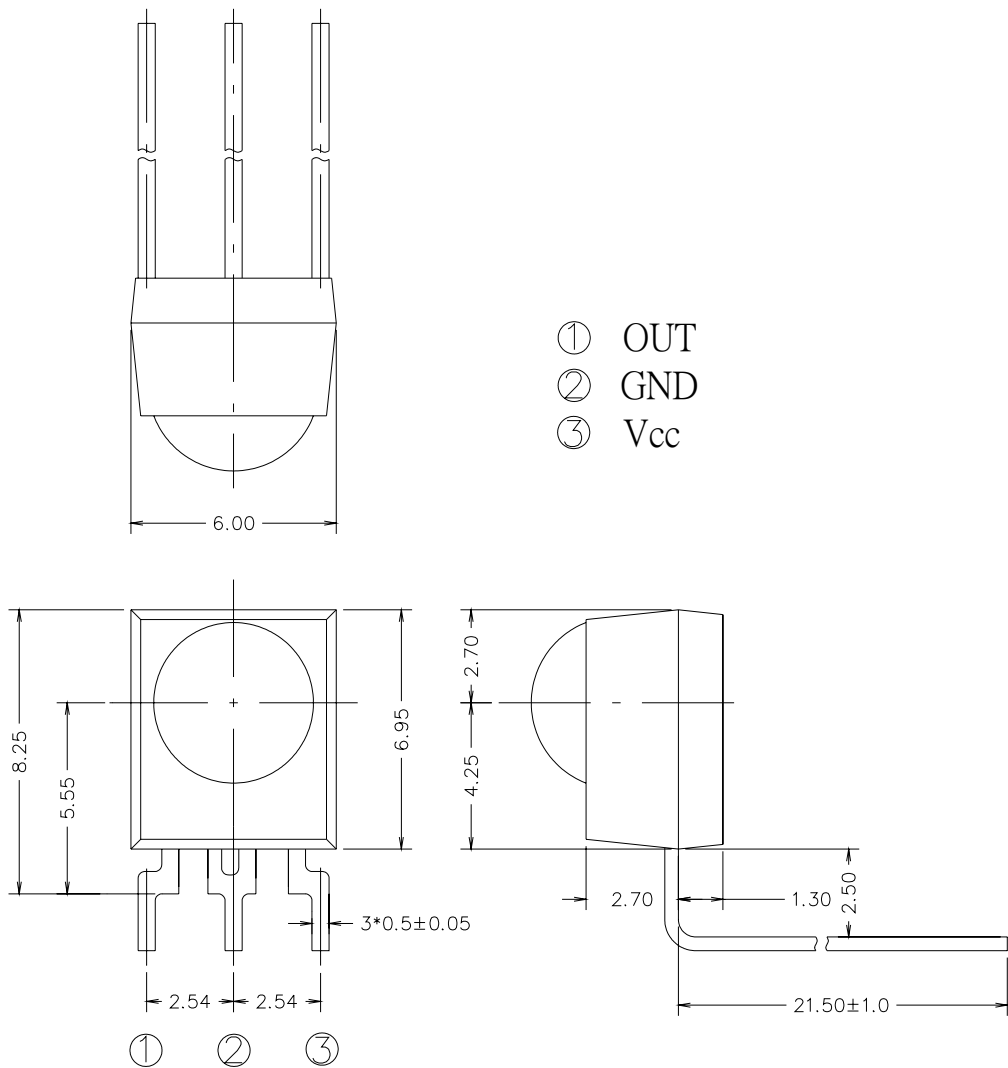

Unit:mm

- Notes:**
- 1.All dimensions are in millimeters.
 - 2.Tolerances unless dimensions ± 0.3 mm.

Absolute Maximum Ratings (Ta=25°C)

Parameter	Symbol	Rating	Unit	Notice
Supply Voltage	Vcc	0~6	V	
Operating Temperature	Topr	-25 ~ +80	°C	
Storage Temperature	Tstg	-40 ~ +85	°C	
Soldering Temperature	Tsol	260	°C	4mm from mold body less than 10 seconds

Recommended Operating Condition
Supply Voltage Rating: Vcc 2.7V to 5.5V
Electro-Optical Characteristics (Ta=25°C, and Vcc=3.0V)

Parameter	Symbol	MIN.	TYP.	MAX.	Unit	Condition
Consumption Current	Icc	---	0.8	1.0	mA	No signal input
B.P.F Center Frequency	Fo	---	38	---	KHz	
Peak Wavelength	λ_p	---	940	---	nm	
Reception Distance	L ₀	14	---	---	m	At the ray axis *1
	L ₄₅	6	---	---		
Half Angle(Horizontal)	Θ_h	---	45	---	deg	
Half Angle(Vertical)	Θ_v	---	45	---	deg	
High Level Pulse Width	T _H	400	---	800	μ s	At the ray axis *2
Low Level Pulse Width	T _L	400	---	800	μ s	
High Level Output Voltage	V _H	2.7	---	---	V	
Low Level Output Voltage	V _L	---	---	0.25	V	

Notes:

*1: The ray receiving surface at a vertex and relation to the ray axis in the range of $\theta=0^\circ$ and $\theta=45^\circ$.

*2: A range from 30cm to the arrival distance. Average value of 50 pulses.

Test Method :

The specified electro-optical characteristics is satisfied under the following Conditions at the controllable distance.

①Measurement place

A place that is nothing of extreme light reflected in the room.

②External light

Project the light of ordinary white fluorescent lamps which are not high Frequency lamps and must be less then 10 Lux at the module surface.

($E_e \leq 10\text{Lux}$)

③Standard transmitter

A transmitter whose output is so adjusted as to **$V_o=400\text{mVp-p}$** and the output Wave form shown in Fig.-1.According to the measurement method shown in Fig.-2 the standard transmitter is specified.

However , the infrared photodiode to be used for the transmitter should be $\lambda_p=940\text{nm}, \Delta\lambda=50\text{nm}$. Also, photodiode is used of PD438B($V_r=5\text{V}$).

(Standard light / Light source temperature 2856°K).

④Measuring system

According to the measuring system shown in Fig.-3

Block Diagram :

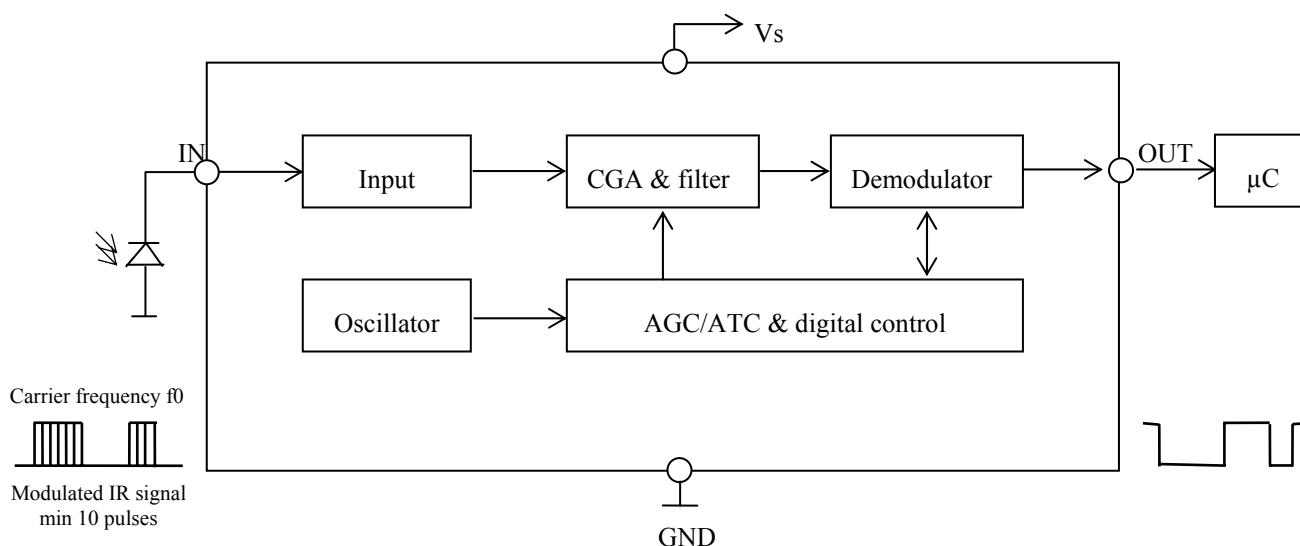

Application Circuit :

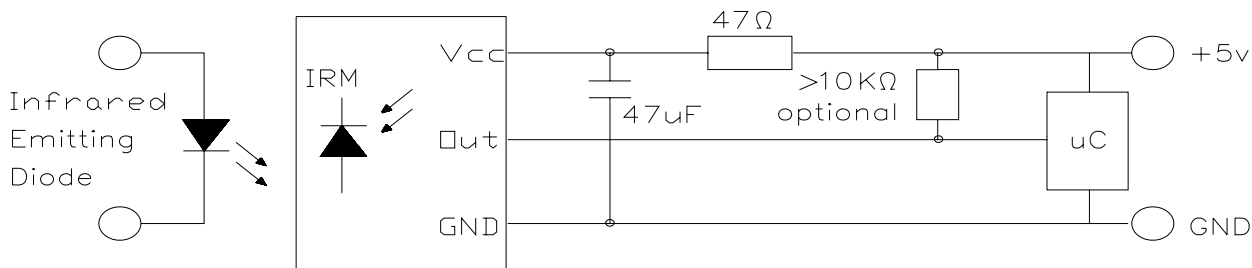

RC Filter should be connected closely between Vcc pin and GND pin.

Fig.-1 Transmitter Wave Form

D.U.T output Pulse

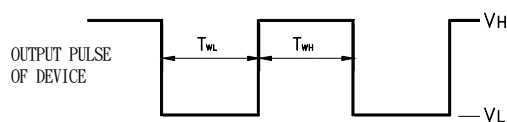
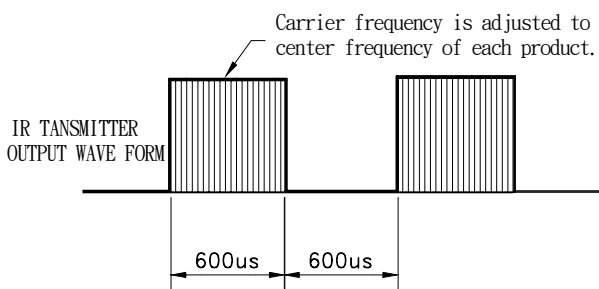

Duty=0.5

Fig.-2 Measuring Method

Fig.-3 Measuring System

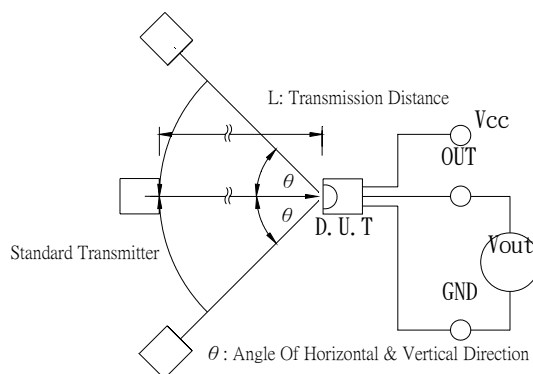
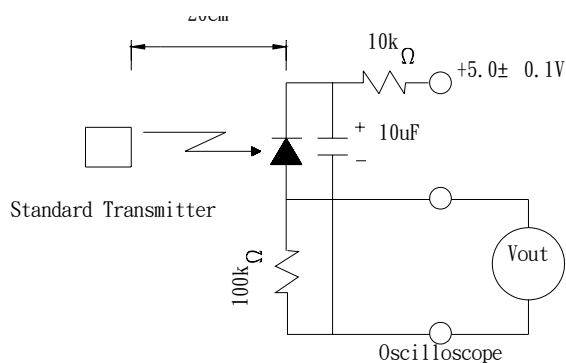

IRM-3638TF4

The Notice of Application:

Transmission of remote control signal consist of four parts: Encode Part, IR Transmitter Source, IRM device, Decode Part

1. When IRM-3638TF4 code select frequency, it need to well understand the center system of encode part.
2. Strong or weak light of IR Transmitter can affect distance of transmission.
3. When using IRM-3638TF4 device, it requires the composition of code pattern to reach the demand as follows:

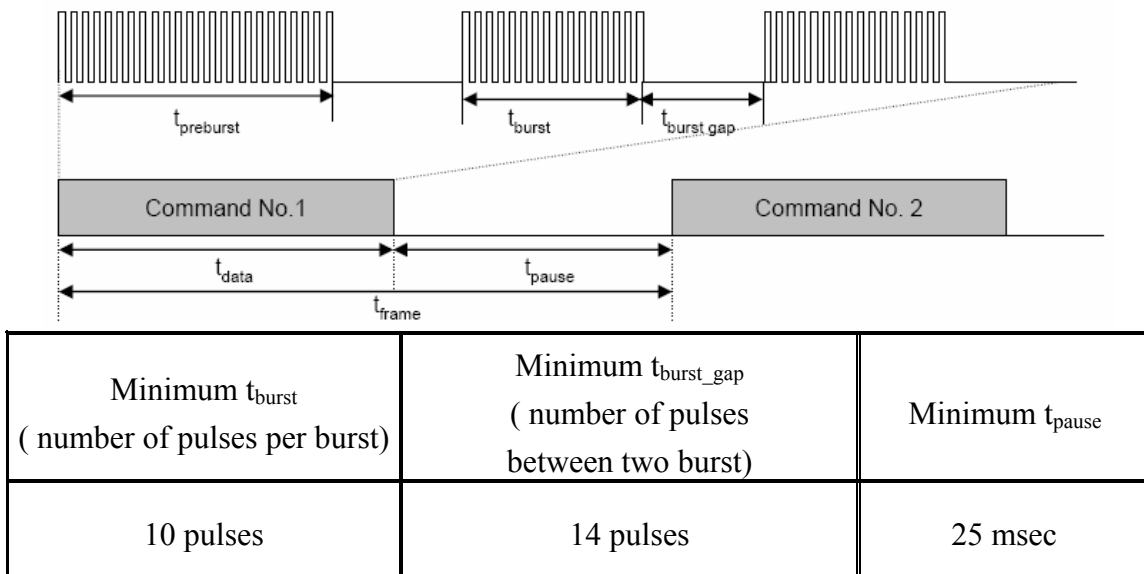

4. It needs to ensure the translation range of decode part if it is applied to the pulse-width range.

If the above items hardly assure of its application, it'll cause NG(no good) message from the edge of signal.

IRM-3638TF4 Code Property:

Data format		Data format	
NEC	O	Sony 12 Bit	O
RC5_Philips	O	Sony 15 Bit	X
RC6_Philips	O	Sony 20 Bit	X
RCA_Thomson	X	Matsushita	O
Toshiba	O	Mitsubishi	O
Sharp	O	Zenith	O
JVC	O	High data rate (4000 bit/s)	X

Typical Electro-Optical Characteristics Curves

Fig.-4 Relative Spectral Sensitivity vs. Wavelength

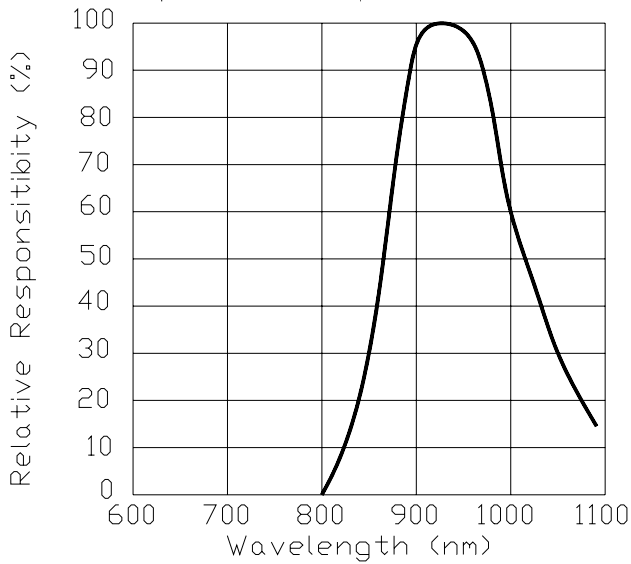

Fig.-5 Relative Transmission Distance vs. Direction

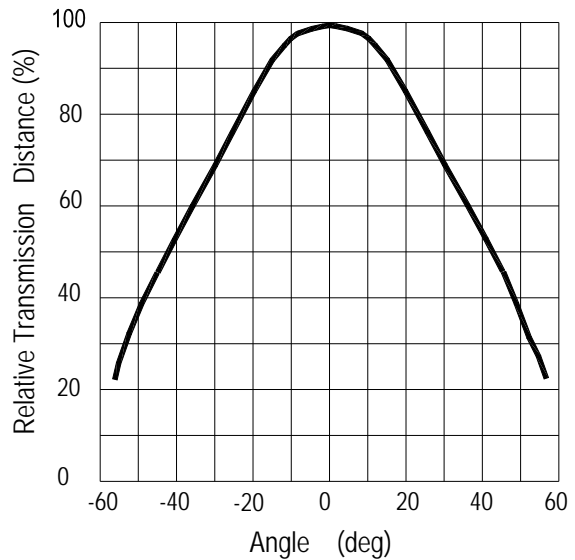

Fig.-6 Output Pulse Length vs. Arrival Distance

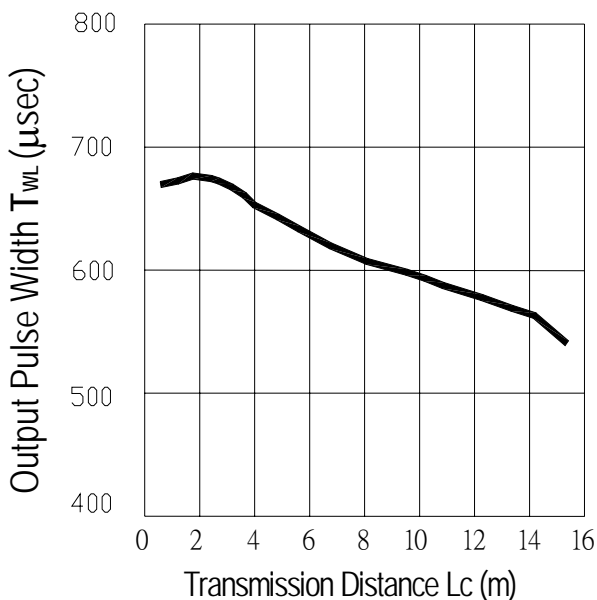
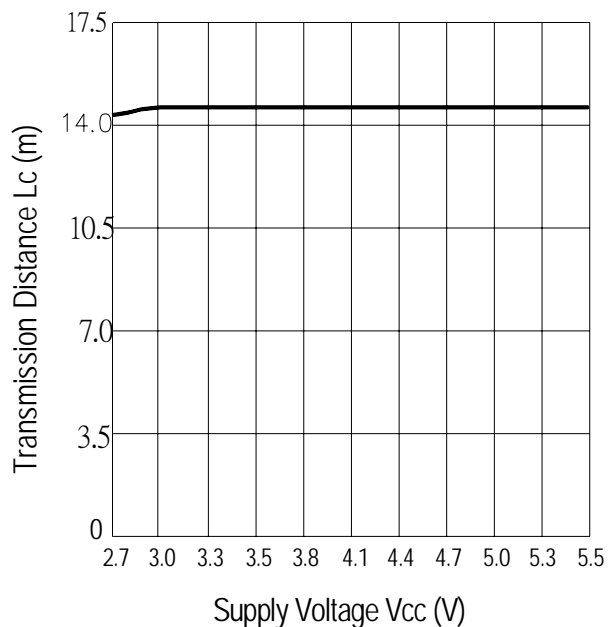

Fig.-7 Arrival Distance vs. Supply Voltage



Typical Electro-Optical Characteristics Curves

Fig.-8 Relative Transmission Distance vs. Center Carrier Frequency

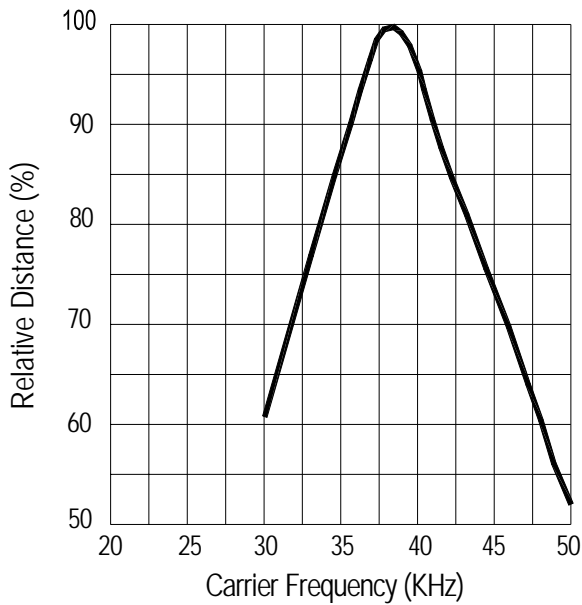
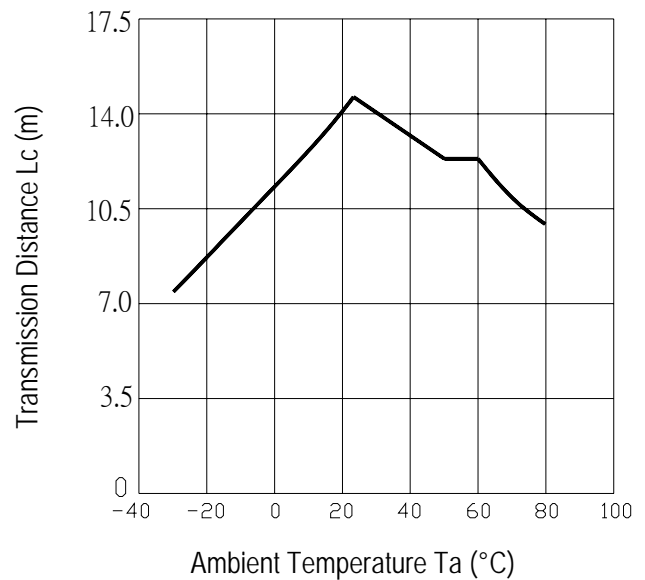

Fig.-9 Arrival Distance vs. Ambient Temperature



Reliability Test Item And Condition

The reliability of products shall be satisfied with items listed below.

Confidence level : 90%

LTPD : 10%

Test Items	Test Conditions	Failure Judgement Criteria	Samples(n) Defective(c)
Temperature cycle	1 cycle -40°C \longleftrightarrow +100°C (15min)(5min)(15min) 300 cycle test	$L_0 \leq L \times 0.8$ $L_{45} \leq L \times 0.8$ L: Lower specification limit	n=22,c=0
High temperature test	Temp: +100°C Vcc:6V 1000hrs		n=22,c=0
Low temperature storage	Temp: -40°C 1000hrs		n=22,c=0
High temperature High humidity	Ta: 85°C,RH:85% 1000hrs		n=22,c=0
Solder heat	Temp: 260±5°C 10sec 4mm From the bottom of the package.		n=22,c=0

Packing Quantity Specification

1. 1500 PCS/1Box
2. 10 Boxes/1Carton

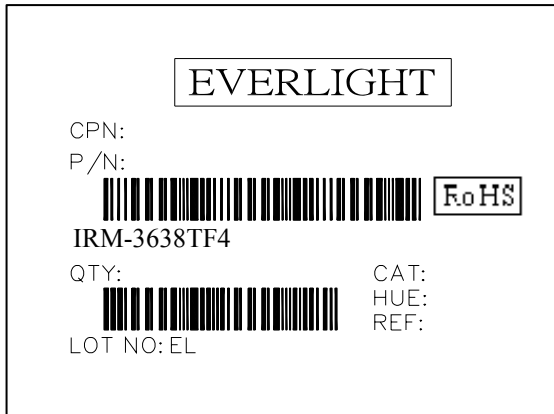
Label Form Specification

CPN: Customer's Production Number
P/N : Production Number
QTY: Packing Quantity
CAT: Ranks
HUE: None
REF: Reference
LOT No: Lot Number
MADE IN TAIWAN: Production Place

Notes

1. Above specification may be changed without notice. EVERLIGHT will reserve authority on material change for above specification.
2. When using this product, please observe the absolute maximum ratings and the instructions for using outlined in these specification sheets. EVERLIGHT assumes no responsibility for any damage resulting from use of the product which does not comply with the absolute maximum ratings and the instructions included in these specification sheets.
3. These specification sheets include materials protected under copyright of EVERLIGHT corporation. Please don't reproduce or cause anyone to reproduce them without EVERLIGHT's consent.

EVERLIGHT ELECTRONICS CO., LTD.

Office: No 25, Lane 76, Sec 3, Chung Yang Rd,
Tucheng, Taipei 236, Taiwan, R.O.C

Tel: 886-2-2267-2000, 2267-9936

Fax: 886-2267-6244, 2267-6189, 2267-6306

<http://www.everlight.com>