

**SUPER-COMPACT SIZE, FLAT-PACKAGE****DESCRIPTION**

NEXEM UC2/UD2 relay is a new generation miniature signal relay, super-compact and slim.

**FEATURES**

- Small mounting size of flat package for dense mounting
- Telcordia (2500 V) and FCC (1500 V) surge capacity
- IEC60950/UL1950/EN60950 spacing and high breakdown voltage  
(Basic insulation class on 200 V working voltage)
- Low power consumption (100-140 mW)

**APPLICATIONS**

Electronic switching systems, PBX, Terminal equipment, Telephone system

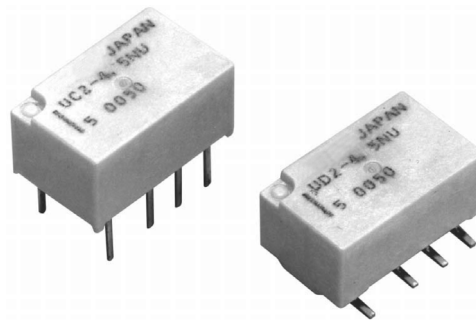
**For Right Use of Miniature Relays****DO NOT EXCEED MAXIMUM RATINGS.**

Do not use relays under exceeding conditions such as over ambient temperature, over voltage and over current. Incorrect use could result in abnormal heating, damage to related parts or cause burning.

**READ CAUTIONS IN THE SELECTION GUIDE.**

Read the cautions described in EM Devices' "Miniature Relays" when you choose relays for your application.

The information in this document is subject to change without notice.

DIMENSIONS AND PAD LAYOUTS

Unit: mm (inch)

UC2 SERIES

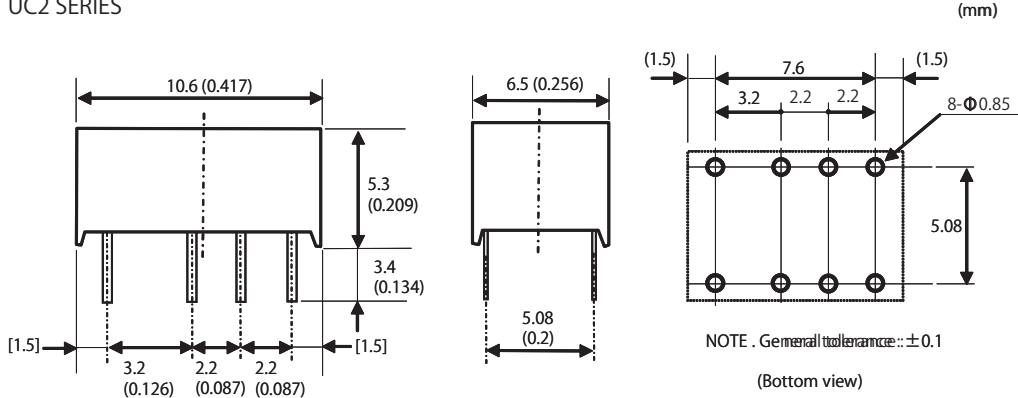

Tolerance of lead pitch is  $\pm 0.15\text{mm}$  (0.006inch)  
 Other tolerances  $\pm 0.3\text{mm}$  (0.012inch)  
 NJ type: Lead length 2.8mm

Lead size 0.4x0.2  $\pm 0.1$

UD2 SERIES

STANDARD

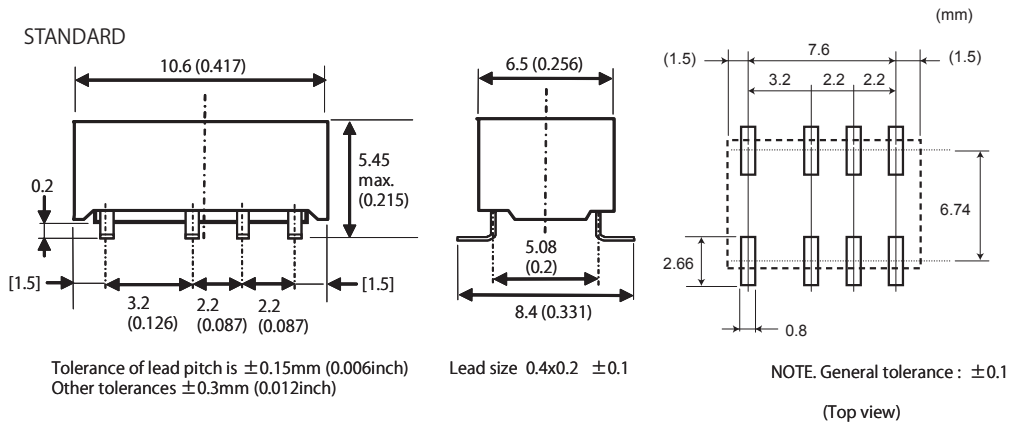

Tolerance of lead pitch is  $\pm 0.15\text{mm}$  (0.006inch)  
 Other tolerances  $\pm 0.3\text{mm}$  (0.012inch)

Lead size 0.4x0.2  $\pm 0.1$

MINIMUM FOOTPRINT TYPE

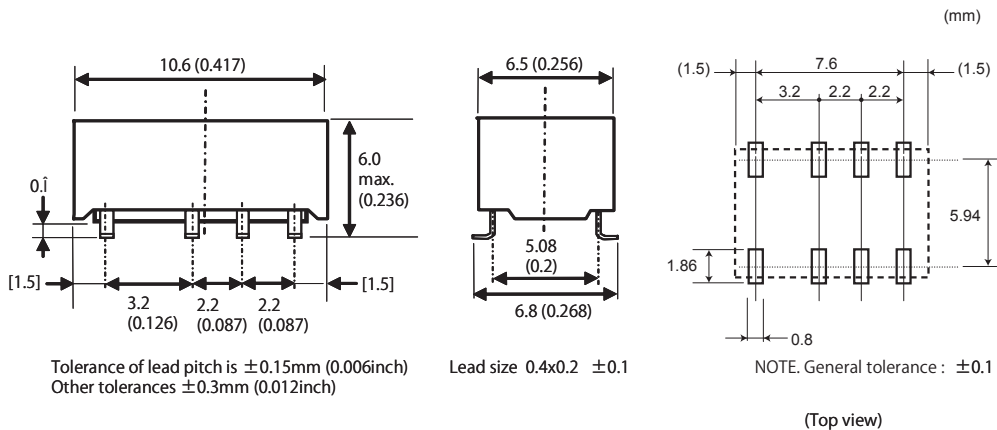

Tolerance of lead pitch is  $\pm 0.15\text{mm}$  (0.006inch)  
 Other tolerances  $\pm 0.3\text{mm}$  (0.012inch)

Lead size 0.4x0.2  $\pm 0.1$



- All specifications in this catalog and production status of products are subject to change without notice. Prior to the purchase, please contact EM Devices for updated product data.
- Please request for a specification sheet for detailed product data prior to the purchase.
- Before using the product in this catalog, please read "Precautions" and other safety precautions listed in the printed version catalog.

**PIN CONFIGURATIONS** (Bottom view)

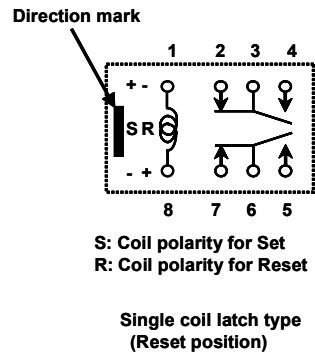
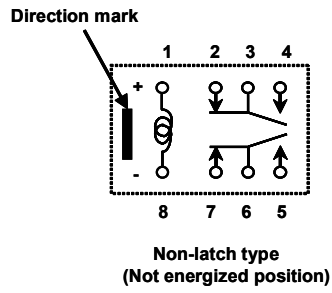

**MARKINGS** (top view)

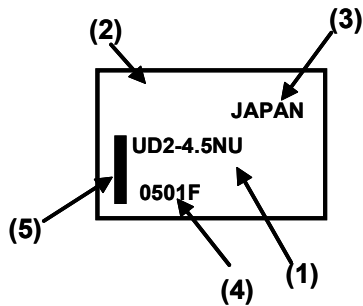

- (1) Part number
- (2) Manufacturer
- (3) Country of origin
- (4) Date code
- (5) Direction mark (pin No. 1 and 8)

**GENERAL SPECIFICATIONS**

Contact Form		2 Form C
Contact Material		Silver alloy with gold alloy overlay
Contact Ratings	Maximum Switching Power	30 W, 37.5 VA
	Maximum Switching Voltage	220 VDC, 250 VAC
	Maximum Switching Current	1 A
	Maximum Carrying Current	1 A
Minimum Contact Ratings		10 m VDC, 10 $\mu$ A *1
Initial Contact Resistance		100 m $\Omega$ max. (initial)
Operate Time (Excluding bounce)		Approx. 2 ms
Release Time (Excluding bounce)		Approx. 1 ms
Insulation Resistance		1000 M $\Omega$ at 500 VDC
Withstanding Voltage	Between open contacts	1000 VAC (for one minute) 1500 V surge (10x160 $\mu$ s *2)
	Between adjacent contacts	1000 VAC (for one minute) 1500 V surge (10x160 $\mu$ s *2)
	Between coil and contacts	1500 VAC (for one minute) , 2500 V surge (2x10 $\mu$ s *3)
Shock Resistance		735 m/s <sup>2</sup> (75G) (misoperation) 980 m/s <sup>2</sup> (100G) (destructive failure)
Vibration Resistance		10 to 55 Hz, double amplitude 3 mm(20G) (misoperation) 10 to 55 Hz, double amplitude 5 mm(30G) (destructive failure)
Ambient Temperature		-40 to +85 °C -40 to +70 °C (Low power consumption type)
Coil Temperature Rise		18 °C at nominal coil voltage (140mW)
Running Specifications	Non-load	5x10 <sup>7</sup> operations (Non-latch type) *4 1x10 <sup>7</sup> operations (Latch type)
	Load	30 VDC 1A (resistive), 1x10 <sup>5</sup> operations at 20°C,1Hz 125 VAC 0.3A (resistive), 1x10 <sup>5</sup> operations at 20°C,1Hz
Weight		Approx. 0.8 g

\* 1 This value is a reference value in the resistance load.

Minimum capacity changes depending on switching frequency and environment temperature and the load.

\* 2 rise time: 10  $\mu$ s, decay time to half crest: 160  $\mu$ s

\* 3 rise time: 2  $\mu$ s, decay time to half crest: 10  $\mu$ s

\* 4 This shows the number of operations with fatal defects. Stable characteristics are maintained for 1 x 10<sup>7</sup> operations.

**COIL SPECIFICATIONS**

<b>Non-latch Type</b>					at 20°C
Nominal Coil Voltage (VDC)	Coil Resistance (Ω)±10%	Must Operate Voltage* (VDC)	Must Release Voltage* (VDC)	Nominal Operating Power (mW)	
3	64.3	2.25	0.3	140	
4.5	145	3.38	0.45	140	
5	178	3.75	0.5	140	
9	579	6.75	0.9	140	
12	1028	9.0	1.2	140	

<b>Single Coil Latch Type</b>					at 20°C
Nominal Coil Voltage (VDC)	Coil Resistance (Ω)±10%	Set Voltage* (VDC)	Reset Voltage* (VDC)	Nominal Operating Power (mW)	
3	90	2.25	2.25	100	
4.5	202.5	3.38	3.38	100	
5	250	3.75	3.75	100	
9	810	6.75	6.75	100	
12	1440	9.0	9.0	100	

<b>Non-latch Low Power Consumption Type</b>					at 20°C
Nominal Coil Voltage (VDC)	Coil Resistance (Ω)±10%	Must Operate Voltage* (VDC)	Must Release Voltage* (VDC)	Nominal Operating Power (mW)	
3	90	2.4	0.3	100	
4.5	202.5	3.6	0.45	100	
5	250	4.0	0.5	100	

Note \* Test by pulse voltage

**SAFETY STANDARD AND RATING**

UL Recognized (UL508)* File No E73266	CSA Certificated (CSA C22.2 No14)** File No LR46266	TUV Certificate (EN61810)
30 VDC, 1 A (Resistive) 110 VDC, 0.3 A (Resistive) 125 VAC, 0.5 A (Resistive)		No. 2050596
		Creepage and clearance of coil to contact is more than 2 mm. (According to EN60950)
		Basic insulation class

\* Spacing: UL840, \*\*Spacing :CSA std950

**RECOMMENDED RELAY DRIVE CONDITIONS**

Drive under conditions. If it is impossible, please inquire to EM Devices.

Non-latch type	Voltage: within ±5% of nominal voltage	Ambient temperature - 40 to +85 °C
Non-latch type (Low power consumption Type)		Ambient temperature - 40 to +70 °C
Single coil latch type	Square pulse (rise and fall time is rapidly) pulse height : within ±5% of nominal voltage pulse width : more than 10 ms	Ambient temperature - 40 to +85 °C

**PART NUMBER SYSTEM**

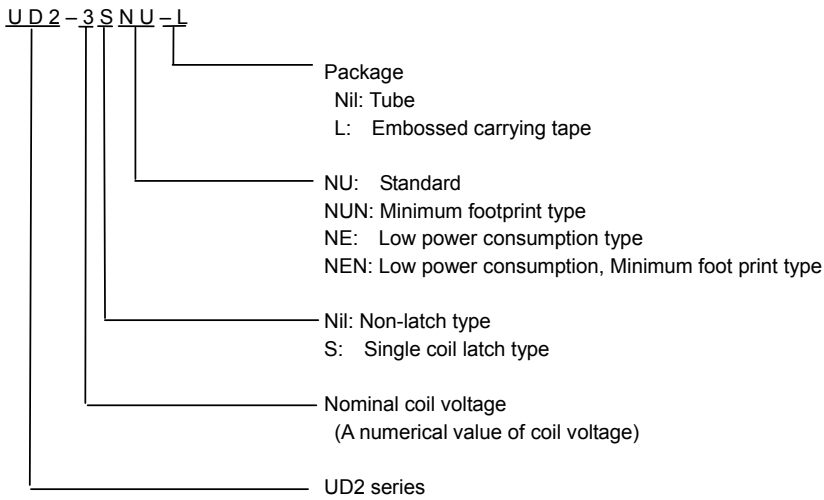
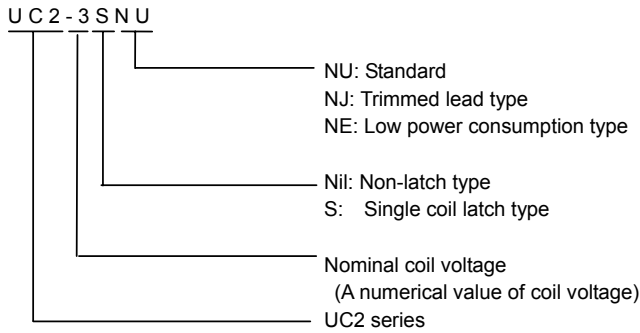

**ORDERING PART NUMBERS**

**UC2 series**

Option		Nominal Coil Voltage (VDC)	Coil Type		
Terminal	Packing		Non-latch	Single Coil Latch	Non-latch Low Power Consumption
Standard	Tube	3	UC2-3NU	UC2-3SNU	UC2-3NE
		4.5	UC2-4.5NU	UC2-4.5SNU	UC2-4.5NE
		5	UC2-5NU	UC2-5SNU	UC2-5NE
		9	UC2-9NU	UC2-9SNU	-
Trimmed lead		3	UC2-3NJ	UC2-3SNJ	-
		4.5	UC2-4.5NJ	UC2-4.5SNJ	-
		5	UC2-5NJ	UC2-5SNJ	-
		9	UC2-9NJ	UC2-9SNJ	-
		12	UC2-12NJ	UC2-12SNJ	-



- All specifications in this catalog and production status of products are subject to change without notice. Prior to the purchase, please contact EM Devices for updated product data.
- Please request for a specification sheet for detailed product data prior to the purchase.
- Before using the product in this catalog, please read "Precautions" and other safety precautions listed in the printed version catalog.

□ **UD2 series**

Option		Nominal Coil Voltage (VDC)	Coil Type		
Terminal	Packing		Non-latch	Single Coil Latch	Non-latch Low Power Consumption
Standard	Tube	3	UD2-3NU	UD2-3SNU	UD2-3NE
		4.5	UD2-4.5NU	UD2-4.5SNU	UD2-4.5NE
		5	UD2-5NU	UD2-5SNU	UD2-5NE
		9	UD2-9NU	UD2-9SNU	-
		12	UD2-12NU	UD2-12SNU	-
	Taping	3	UD2-3NU-L	UD2-3SNU-L	UD2-3NE-L
		4.5	UD2-4.5NU-L	UD2-4.5SNU-L	UD2-4.5NE-L
		5	UD2-5NU-L	UD2-5SNU-L	UD2-5NE-L
		9	UD2-9NU-L	UD2-9SNU-L	-
		12	UD2-12NU-L	UD2-12SNU-L	-
Minimum footprint	Tube	3	UD2-3NUN	UD2-3SNUN	UD2-3NEN
		4.5	UD2-4.5NUN	UD2-4.5SNUN	UD2-4.5NEN
		5	UD2-5NUN	UD2-5SNUN	UD2-5NEN
		9	UD2-9NUN	UD2-9SNUN	-
		12	UD2-12NUN	UD2-12SNUN	-
	Taping	3	UD2-3NUN-L	UD2-3SNUN-L	UD2-3NEN-L
		4.5	UD2-4.5NUN-L	UD2-4.5SNUN-L	UD2-4.5NEN-L
		5	UD2-5NUN-L	UD2-5SNUN-L	UD2-5NEN-L
		9	UD2-9NUN-L	UD2-9SNUN-L	-
		12	UD2-12NUN-L	UD2-12SNUN-L	-

PERFORMANCE DATA

□ COIL TEMPERATURE RISE

Temperature is measured by coil resistance

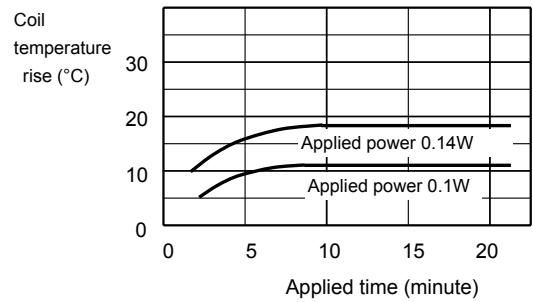
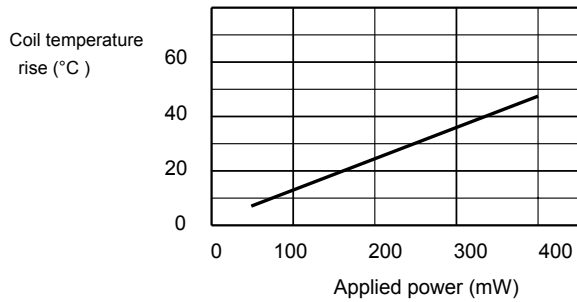

□ SWITCHING CAPACITY

This is allowed maximum value.

Inquire with EM Devices for maximum value under continuous

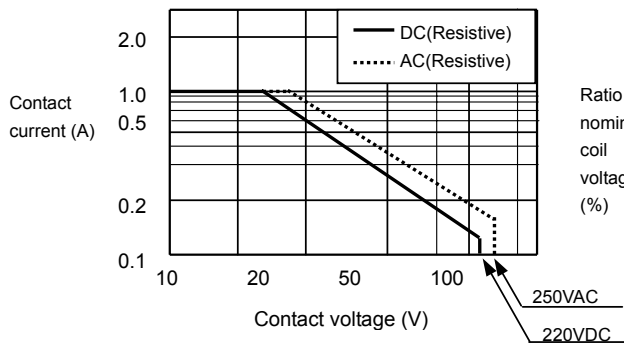

□ MAXIMUM COIL VOLTAGE

This is a maximum value of permissible alteration.

Inquire with EM Devices under continuous use.

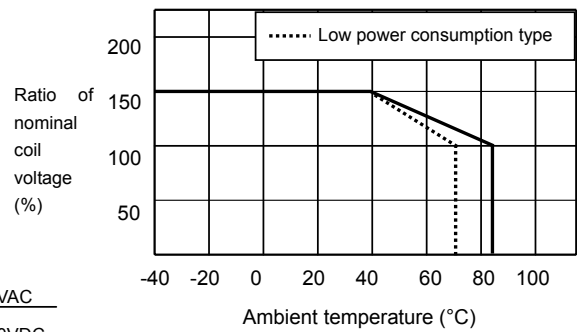

□ APPLIED VOLTAGE VS. TIMING (Sample:UC2-5NU)

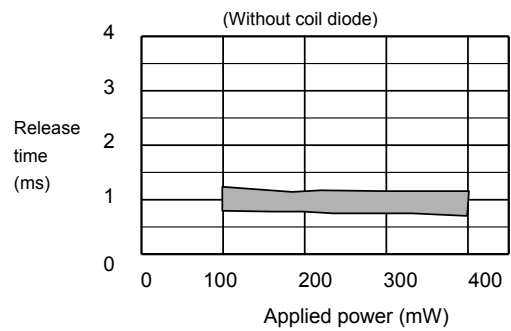
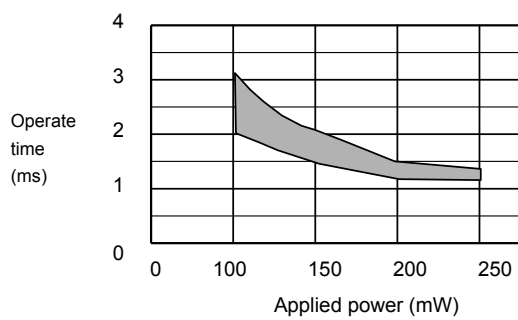



□ OPERATE AND RELEASE VOLTAGE VS.AMBIENT TEMPERATURE

This shows a typical change of operate (release) voltage. The value of must operate is estimated, so coil voltage must be applied more than this value for safety operation. For hot start operation, please inquire with EM Devices.

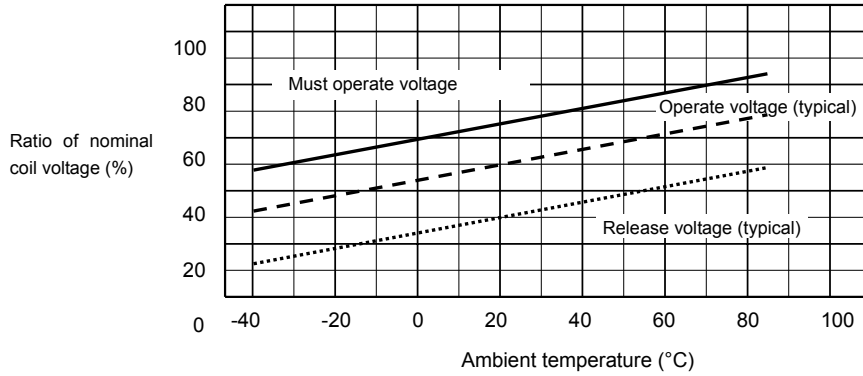

□ RUNNING TEST (Non-load)

(Load: none, Drive:5VDC, 50Hz, 50%duty, Ambient temperature :room temperature, Sample:UC2-5NU ,20pieces)

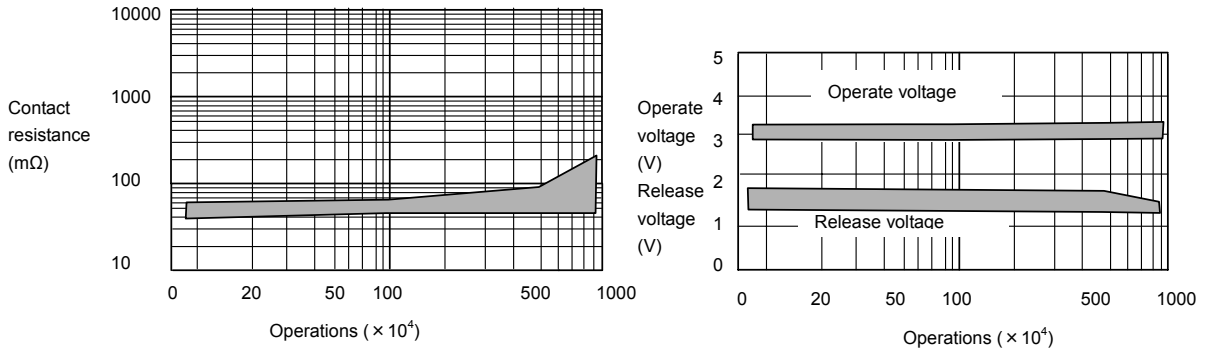

□ RUNNING TEST(Load)

(Load: 50VDC 0.1A resistive, Drive:5VDC,5Hz,50%duty,Ambient temperature:85 °C, Sample:UC2-5NU ,10pieces)

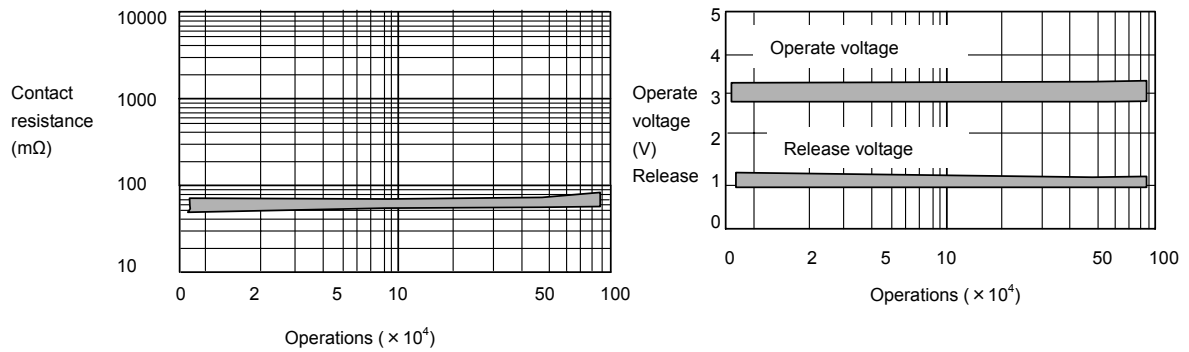

□ BREAKDOWN VOLTAGE

Sample: UC2-5NU 10peices

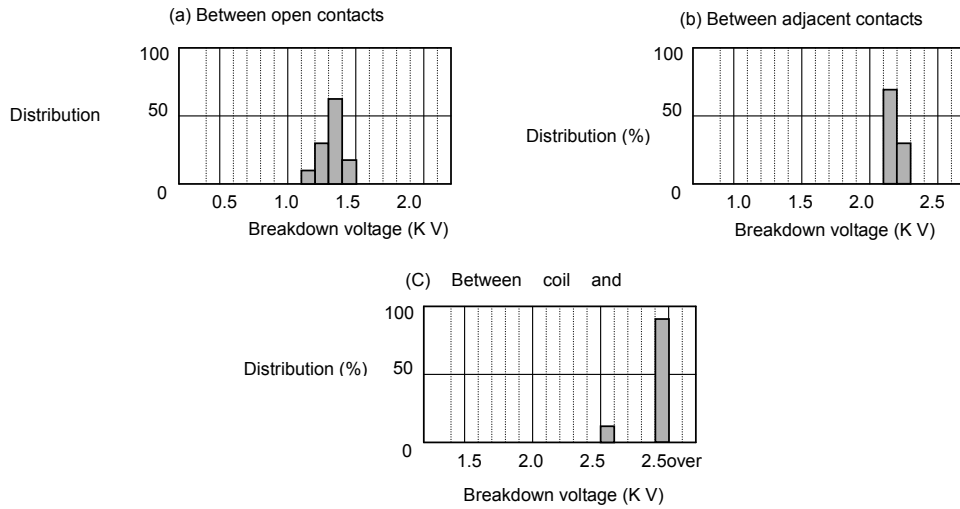

□ ALTERNATION OF VOLTAGE IN DENSE MOUNTING (Magnetic interference)

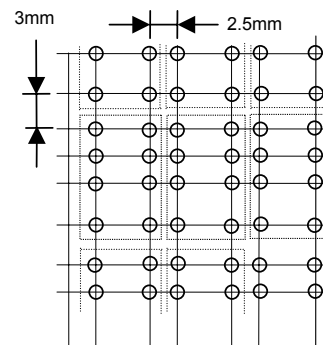
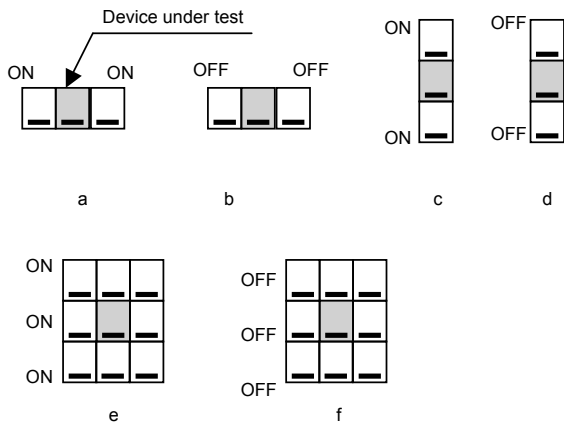
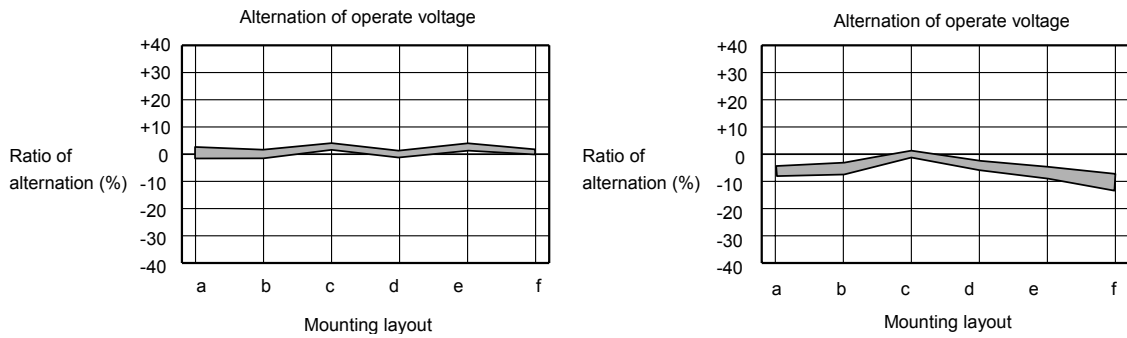

**PACKING DIMENSIONS (Unit: mm)**

**TUBE PACKING (UC2/UD2)**

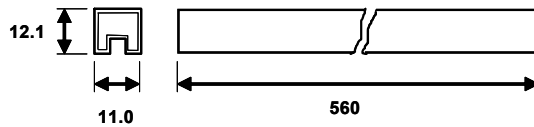

50 pieces / Tube (anti-static)

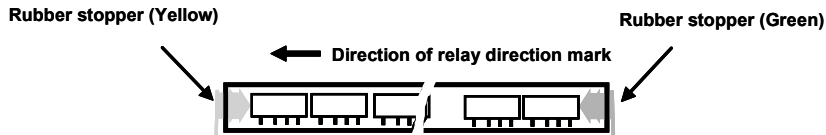

**TAPE PACKING (UD2)**

**APPEARANCE**

1200 pieces / Reel  
Reel diameter: 380mm

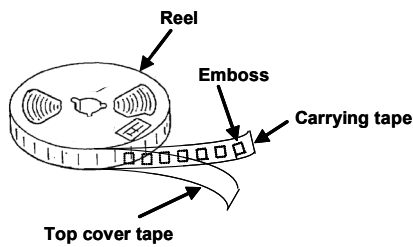

**TAPE DIMENSIONS**

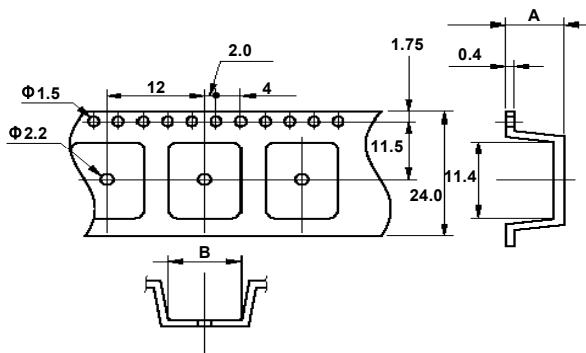

	A	B
UD2-xxNU-L UD2-xxNE-L	Max.6.2	9.2
UD2-xxNUN-L UD2-xxNEN-L	Max.6.6	7.5

**RELAY DIRECTION AND TAPE CARRYING DIRECTION**

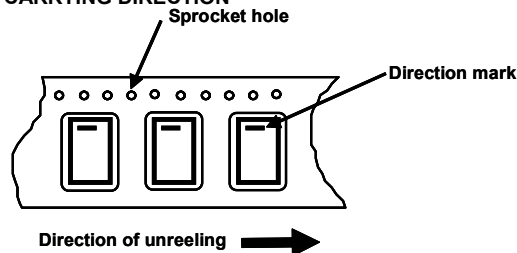

**SOLDERING TEMPERATURE CONDITION**

**THROUGH-HOLE MOUNTING (UC2/UD2)**

1. Automatic soldering

Preheating: 110~ 120°C /110 sec. (max.)  
 Solder temperature: 260°C max.  
 Solder time: 5 seconds max.

Note: EM Devices recommends cooling down a printed circuit board less than 110°C within 40 seconds after soldering.

2. Manual soldering

Solder temperature: 350°C max.  
 Solder time: 3 seconds max.

**SURFACE-MOUNTING TYPE (UD2)**

IRS Method

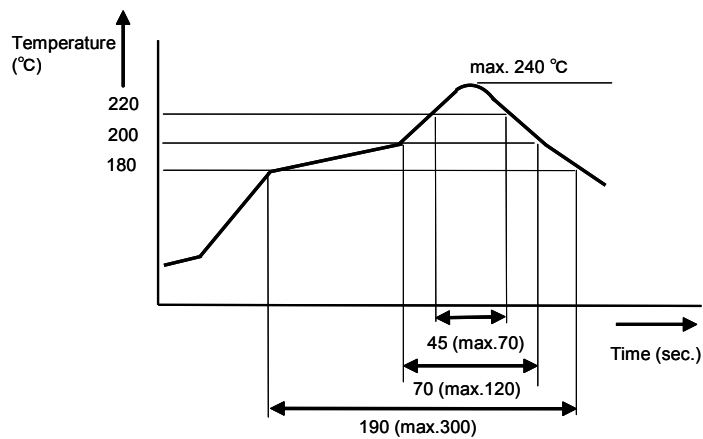

Note:

1. Temperature profile shows printed circuit board surface temperature on the relay terminal portion.
2. Check the actual soldering condition to use other method except above mentioned temperature profiles.

**NOTE ON CORRECT USE**

1. Notes on contact load

Make sure that the contact load is within the specified range; otherwise, the lifetime of the contacts will be shortened considerably.

Note that the running performance shown is an example, and that it varies depending on parameters such as the type of load, switching frequency, driver circuit, and ambient temperature under the actual operating conditions. Evaluate the performance by using the actual circuit before using the relay.

2. Driving relays

- If the internal connection diagram of a relay shows + and - symbols on the coil, apply the rated voltage to the relay in the specified direction. If a rippled DC current source is used, abnormalities such as beat at the coil may occur.

- The maximum voltage that can be applied to the coil of the relay varies depending on the ambient temperature. Generally, the higher the voltage applied to the coil, the shorter the operating time. Note, however, that a high voltage also increases the bounce of the contacts and the contact opening and closing frequency, which may shorten the lifetime of the contacts.

- If the driving voltage waveform of the relay coil rises and falls gradually, the inherent performance of the relay may not be fully realized. Make sure that the voltage waveform instantaneously rises and falls as a pulse.

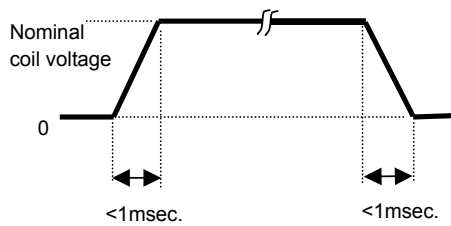

- For a latching relay, apply a voltage to the coil according to the polarity specified in the internal connection diagram of the relay.

- If a current is applied to the coil over a long period of time, the coil temperature rises, promoting generation of organic gas inside the relay, which may result in faulty contacts. In this case, use of a latching relay is recommended.

- The operating time and release time indicate the time required for each contact to close after the voltage has been applied to or removed from the coil. However, because the relay has a mechanical structure, a bounce state exists at the end of the operating and release times. Furthermore, because additional time is required until the contact stabilizes after being in a high-resistance state, care must be taken when using the relay at high speeds.

3. Operating environment

- Make sure that the relay mounted in the application set is

used within the specified temperature range. Use of a relay at a temperature outside this range may adversely affect insulation or contact performance.

- If the relay is used for a long period of time in highly humid (RH 85% or higher) environment, moisture may be absorbed into the relay. This moisture may react with the NOx and SOx generated by glow discharges that occur when the contacts are opened or closed, producing nitric or sulfuric acid. If this happens, the acid produced may corrode the metallic parts of the relay, causing operational malfunction.

- If any material containing silicon (silicon rubber, silicon oil, and silicon based coating material) is used in the neighborhood of relay, there is some possibility that these materials will emit silicon gas that will penetrate the relay. In this case, the switching contact may generate silicon compounds on the surface of contacts. This silicon compound may result in contact failure. Avoid use of relay in such an environment.

- Because the operating temperature range varies depending on the humidity, use the relay in the temperature range illustrated in the figure below. Prevent the relay from being frozen and avoid the generation of condensation.

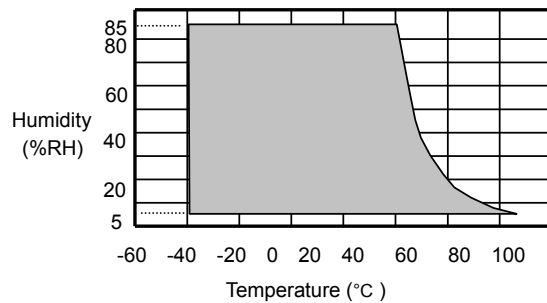

- The relay maintains constant sealability under normal atmospheric pressure (810 to 1,200 hpa). Its sealability may be degraded or the relay may be deformed and malfunction if it is used under barometric conditions exceeding the specified range.

- The same applies when the relay is stored or transported. Keep the upper-limit value of the temperature to which the relay is exposed after it is removed from the carton box to within 50°C.

- Permanent magnets are used in polarized relays. For this reason, when magnets, transformers, or speakers are located nearby the relay characteristics may change and faulty operations may result.

- If excessive vibration or shock is applied to the relay, it may malfunction and the contacts remain closed. Vibration or shock applied to the relay during operation may cause considerable damage to or wearing of the contacts. Note that operation of a snap switch mounted close to the relay or shock due to the operation of magnetic solenoid may also

cause malfunctioning.

#### 4. Notes on mounting relays

- When mounting a relay onto a PC board using an automatic chip mounter, if excessive force is applied to the cover of the relay when the relay is chucked or inserted, the cover may be damaged or the characteristics of the relay degraded. Keep the force applied to the relay to within 1 kg.
- Avoid bending the pins to temporarily secure the relay to the PC board. Bending the pins may degrade sealability or adversely affect the internal mechanism.
- It is recommended to solder the relay onto a PC board under the following conditions:

<1> Reflow soldering

Refer to the recommended soldering temperature profile.

<2> Flow soldering

Solder temperature: 260°C max., Time: 5 seconds max.

Preheating: 110~ 120°C /110 sec. (max.)

<3> Manual soldering

Solder temperature: 350°C, Time: 2~3 seconds

- Ventilation immediately after soldering is recommended. Avoid immersing the relay in cleaning solvent immediately after soldering due to the danger of thermal shock being applied to the relay.
- Use an alcohol-based or water-based cleaning solvent. Never use thinner and benzene because they may damage the relay housing.
- Do not use ultrasonic cleaning because the vibration energy generated by the ultrasonic waves may cause the contacts to remain closed.

#### 5. Handling

- Relays are packaged in magazine cases for shipment. If a space is created in the case after some relays have been removed, be sure to insert a stopper to secure the remaining relays in the case. If relays are not well secured, vibration during transportation may cause malfunctioning of the contacts.
- Exercise care in handling the relay so as to avoid dropping it or allowing it to fall. Do not use a relay that has been dropped. If a relay drops from a workbench to the floor, a shock of 9,800 m/s<sup>2</sup> (1,000 G) or more is applied to the relay, possibly damaging its functions. Even if a light shock has been applied to the relay, thoroughly evaluate its operation before using it.
- Latching relays are factory-set to the reset state for shipment. A latching relay may be set, however, by vibration or shock applied while being transported. Be sure to forcibly reset the relay before using it in the application set. Also note that the relay may be set by unexpected vibration or shock when it is used in a portable set.
- The sealability of a surface-mount (SMT) relay may be lost if the relay absorbs moisture and is then heated during soldering. When storing relays, therefore, observe the following points:
  - <1> For standard packing, please use relays within 12 months after delivery. (Storage conditions: 30 °C / 60% RH)If the relays have moisture absorption, dehumidify as follows.
  - Tape packing: 50±5 °C, 200~300 hours.

Simple relay: 85±5 °C, 48 hours.

<2> For MBB packing, please use relays within 2 years after delivery.

(Storage conditions: 30 °C / 60% RH)

After open MBB packing, please use within 3 months.

(Storage conditions: 30 °C / 60% RH)

No part of this document may be copied or reproduced in any form or by any means without the prior written consent of EM Devices Corporation. EM Devices Corporation assumes no responsibility for any errors which may appear in this document.

EM Devices Corporation does not assume any liability for infringement of patents, copyrights or other intellectual property rights of third parties by or arising from use of a device described herein or any other liability arising from use of such device. No license, either express, implied or otherwise, is granted under any patents, copyrights or other intellectual property rights of EM Devices Corporation or others.

While EM Devices Corporation has been making continuous effort to enhance the reliability of its electronic components, the possibility of defects cannot be eliminated entirely. To minimize risks of damage or injury to persons or property arising from a defect in an EM Devices electronic component, customers must incorporate sufficient safety measures in its design, such as redundancy, fire-containment, and anti-failure features. EM Devices' products are classified into the following three quality grades:

"Standard," "Special," and "Specific". The Specific quality grade applies only to devices developed based on a customer designated "quality assurance program" for a specific application. The recommended applications of a device depend on its quality grade, as indicated below. Customers must check the quality grade of each device before using it in a particular application.

Standard: Computers, office equipment, communications equipment, test and measurement equipment, audio and visual equipment, home electronic appliances, machine tools, personal electronic equipment and industrial robots

Special: Transportation equipment (automobiles, trains, ships, etc.), traffic control systems, anti-disaster systems, anti-crime systems, safety equipment and medical equipment (not specifically designed for life support)

Specific: Aircrafts, aerospace equipment, submersible repeaters, nuclear reactor control systems, life support systems or medical equipment for life support, etc.

The quality grade of EM Devices' products are "Standard" unless otherwise specified in EM Devices' Data Sheets or Data Books. If customers intend to use EM Devices' products for applications other than those specified for Standard quality grade, they should contact an EM Devices sales representative in advance.

(Note)

- (1) "EM Devices" as used in this statement means EM Devices Corporation and also includes its majority-owned subsidiaries.
- (2) "EM Devices electronic component products" means any electronic component product developed or manufactured by or for EM Devices (as defined above).