



# LED Display Product Data Sheet LSHD-7501

Spec No.: DS30-2002-145

Effective Date: 01/14/2003

Revision: -

**LITE-ON DCC**

**RELEASE**

BNS-OD-FC001/A4

## **FEATURES**

- \* 0.3 inch (7.62 mm ) DIGIT HEIGHT
- \* EXCELLENT SEGMENT UNIFORMITY
- \* LOW POWER REQUIREMENT
- \* HIGH BRIGHTNESS AND HIGH CONTRAST
- \* WIDE VIEWING ANGLE
- \* SOLID STATE RELIABILITY
- \* BINNED FOR LUMINOUS INTENSITY

## **DESCRIPTION**

The LSHD-7501 is a 0.3 inch (7.62 mm) digit height single-digit display. This device uses AS-AlInGaP RED LED chips (AlInGaP epi on GaAs substrate). The display has light gray face and white segments.

## **DEVICE**

<b>PART NO.</b>	<b>DESCRIPTION</b>
AlInGaP RED	Common Anode Rt. Hande Decimal
LSHD-7501	

**PACKAGE DIMENSIONS**

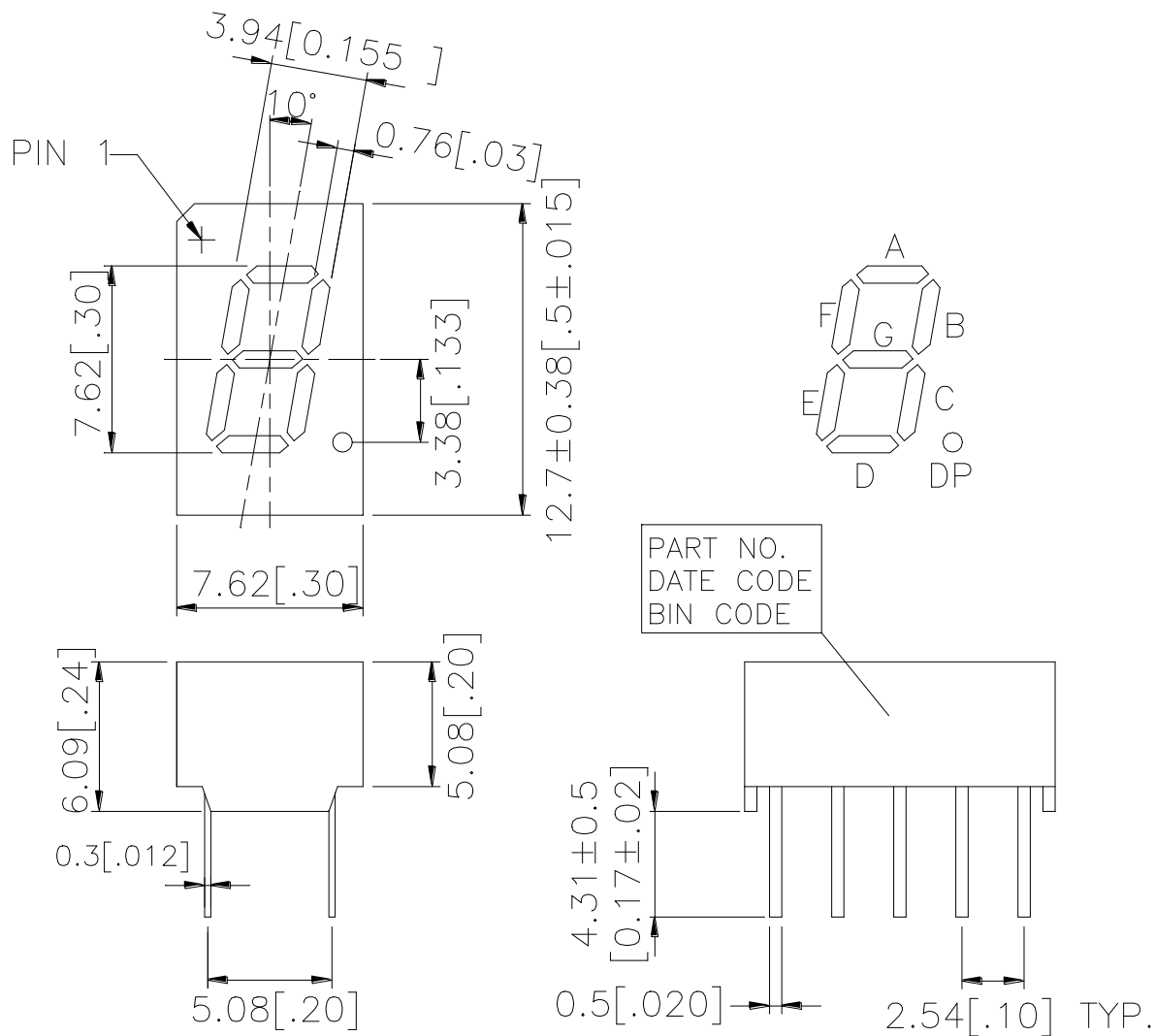

NOTES: All dimensions are in millimeters. Tolerances are ± 0.25mm (0.01") unless otherwise noted.

**INTERNAL CIRCUIT DIAGRAM**

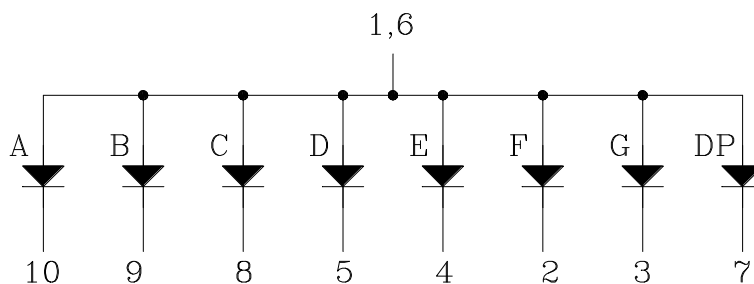

**PIN CONNECTION**

<b>No.</b>	<b>CONNECTION</b>
1	Common Anode
2	Cathode F
3	Cathode G
4	Cathode E
5	Cathode D
6	Common Anode
7	Cathode DP
8	Cathode C
9	Cathode B
10	Cathode A

## ABSOLUTE MAXIMUM RATING AT Ta = 25°C

PARAMETER	MAXIMUM RATING	UNIT
Power Dissipation Per Segment	70	mW
Peak Forward Current Per Segment ( Frequency 1Khz, 15% duty cycle)	90	mA
Continuous Forward Current Per Segment	25	mA
Forward Current Derating from 25°C	0.28	mA/°C
Reverse Voltage Per Segment	5	V
Operating Temperature Range	-35°C to +105°C	
Storage Temperature Range	-35°C to +105°C	
Soldering Conditions : 1/16 inch below seating plane for 3 seconds at 260°C		

## ELECTRICAL / OPTICAL CHARACTERISTICS AT Ta = 25°C

PARAMETER	SYMBOL	MIN	TYP	MAX	UNIT	TEST CONDITION
Average Luminous Intensity Per Segment	I <sub>v</sub>	320 5400	923 12000		μcd	I <sub>F</sub> = 1mA I <sub>F</sub> = 10mA
Peak Emission Wavelength	λ <sub>p</sub>		632		nm	I <sub>F</sub> = 20mA
Spectral Line Half-Width	Δλ		20		nm	I <sub>F</sub> = 20mA
Dominant Wavelength	λ <sub>d</sub>		624		nm	I <sub>F</sub> = 20mA
Forward Voltage Per Segment	V <sub>F</sub>		2.1	2.6	V	I <sub>F</sub> = 20mA
Reverse Current Per Segment	I <sub>R</sub>			100	μA	V <sub>R</sub> = 5V
Luminous Intensity Matching Ratio	I <sub>v</sub> -m			2 : 1		I <sub>F</sub> = 1mA

Note: Luminous Intensity is measured with a light sensor and filter combination that approximates the CIE (Commision Internationale De L'Eclairage) eye-response curve.

## TYPICAL ELECTRICAL / OPTICAL CHARACTERISTIC CURVES

(25°C Ambient Temperature Unless Otherwise Noted)

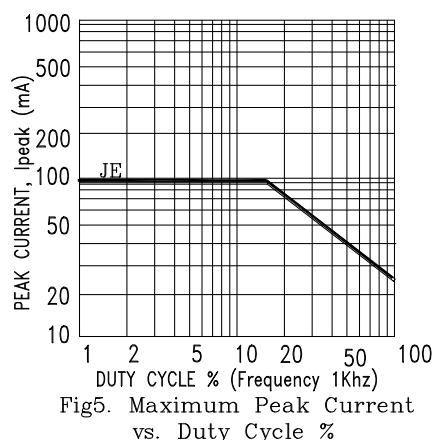
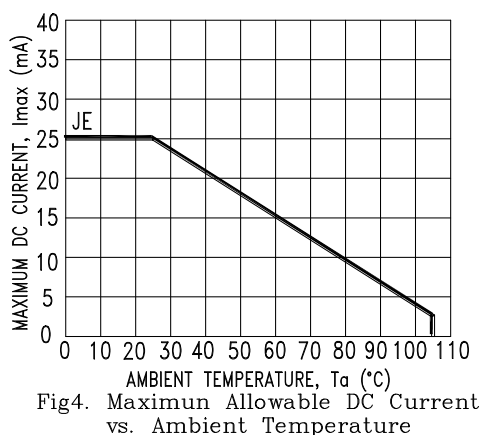
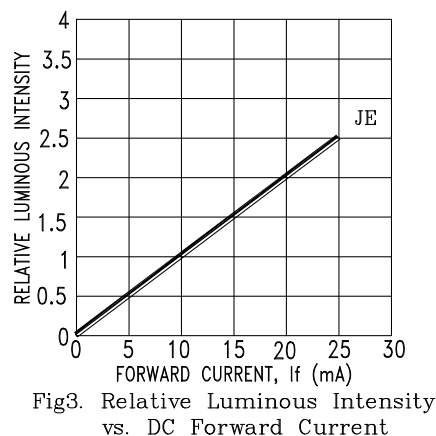
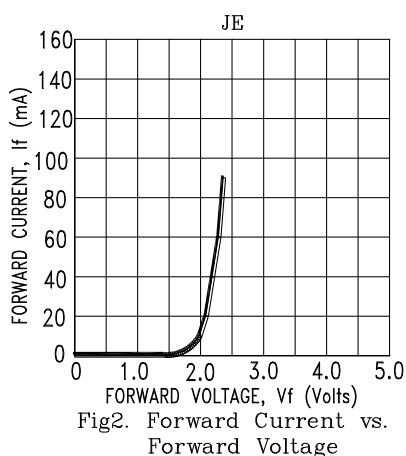
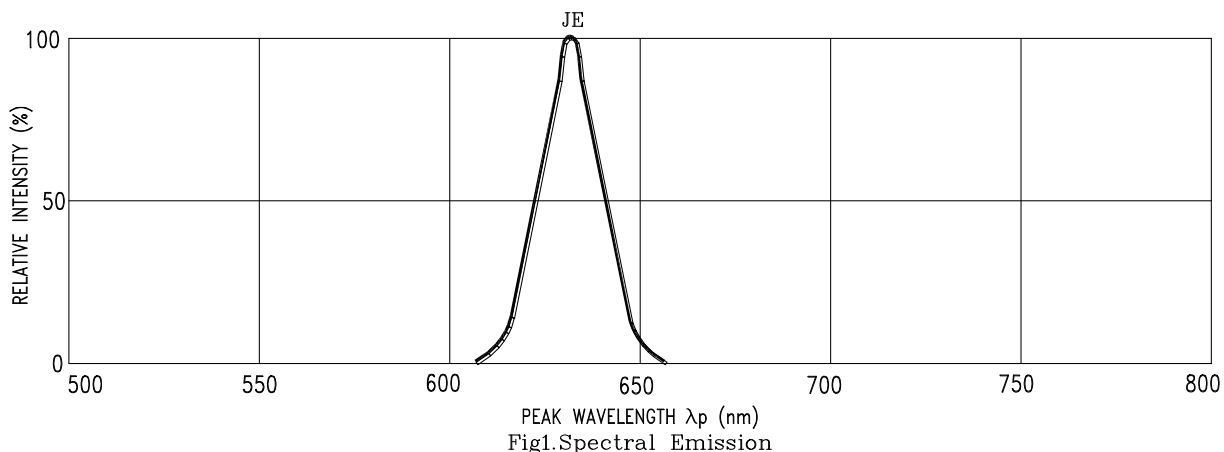

NOTE : JE=AlInGaP RED

# Mouser Electronics

Authorized Distributor

Click to View Pricing, Inventory, Delivery & Lifecycle Information:

[Lite-On:](#)

[LSHD-7501](#)