



DESCRIPTION:

The sidac is a silicon bilateral voltage triggered switch with greater power-handling capabilities than standard diacs. Upon application of a voltage exceeding the sidac breakover voltage point, the sidac switches on through a negative resistance region to a low on-state voltage. Conduction continues until the current is interrupted or drops below the minimum holding current of the device.

APPLICATIONS:

- ✧ High-voltage lamp ignitors
- ✧ Natural gas ignitors
- ✧ Gas oil ignitors
- ✧ High-voltage power supplies
- ✧ Xenon ignitors
- ✧ Overvoltage protector
- ✧ Pulse generators
- ✧ Fluorescent lighting ignitors HID lighting ignitors

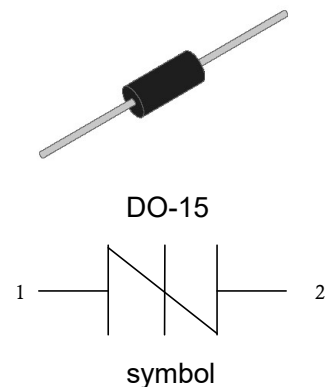

FEATURES:

- ✧ Excellent capability of absorbing transient surge
- ✧ Quick response to surge voltage (ns Level)
- ✧ Glass-passivated junctions
- ✧ High voltage lcmp ignitors

ABSOLUTE MAXIMUM RATINGS (T_A=25°C, RH=45%-75%, unless otherwise noted)

Parameter	Symbol	Value	Unit
Storage temperature range	T _{STG}	-40 to +125	°C
Operating junction temperature range	T _J	-40 to +125	°C
On-state RMS current	I _T	1.0	A
Maximum surge on-state current non-repetitive one cycle peak value (50Hz)	I _{TSM}	16.7	A
Critical rate-of-rise of on-state current	di _T /dt	80	A/μs

ELECTRICAL CHARACTERISTICS (T_A=25°C)

Symbol	Parameter
V _{DRM}	Peak off-state voltage
I _{DRM}	Off-state current
V _S	Switching voltage
I _S	Switching current
R _S	Switching resistance
V _T	On-state voltage
I _H	Holding current
V _{BO}	Breakover Voltage
I _{BO}	Breakover current

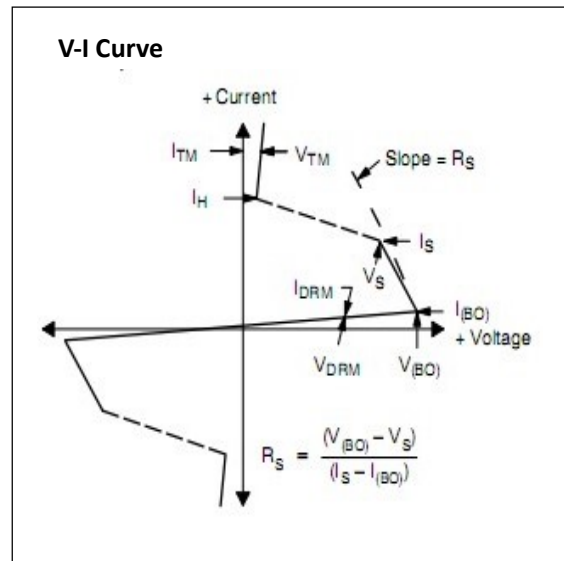

ELECTRICAL CHARACTERISTICS (T_A=25°C, continued)

Part Number	I _{DRM} @V _{DRM}		V _{BO}		I _{BO}	V _T @ I _T =1A	I _H	R _S	Marking
	μA	V	V		μA	V	mA	kΩ	
	max	min	min	max	max	max	min	min	
K0900G	1	70	80	97	50	2	10	0.1	DB090
K1050G	1	90	95	113	50	2	10	0.1	DB105
K1200G	1	100	110	125	50	2	10	0.1	DB120
K1300G	1	110	120	138	50	2	10	0.1	DB130
K1400G	1	120	130	146	50	2	10	0.1	DB140
K1500G	1	130	140	170	50	2	10	0.1	DB150
K1800G	1	160	170	195	50	2	10	0.1	DB180
K2000G	1	180	190	215	50	2	10	0.1	DB200BW
K2200G	1	190	205	230	50	2	10	0.1	DB220BW
K2400G	1	200	220	250	50	2	10	0.1	DB240BW
K2600G	1	220	240	270	50	2	10	0.1	DB260BW

ORDERING INFORMATION

<p>K</p> <p>Series code K:Sidac</p>	<p>XXX</p> <p>Median voltage</p>	<p>0</p> <p>0: Bi-direction 1: Uni-direction</p>	<p>G</p> <p>Package type:DO-15</p>
--	---	---	---

MARKING



SOLDERING PARAMETERS

Reflow Condition		Pb-Free assembly (see FIG.2)
Pre Heat	-Temperature Min ($T_{s(min)}$)	+150°C
	-Temperature Max($T_{s(max)}$)	+200°C
	-Time (Min to Max) (ts)	60-180 secs.
Average ramp up rate (Liquidus Temp (T_L) to peak)		3°C/sec. Max
$T_{s(max)}$ to T_L - Ramp-up Rate		3°C/sec. Max
Reflow	-Temperature(T_L) (Liquidus)	+217°C
	-Temperature(t_L)	60-150 secs.
Peak Temp (T_p)		+260(+0/-5)°C
Time within 5°C of actual Peak Temp (t_p)		30 secs. Max
Ramp-down Rate		6°C/sec. Max
Time 25°C to Peak Temp (T_P)		8 min. Max
Do not exceed		+260°C

FIG.1: Maximum allowable ambient temperature versus on-state current

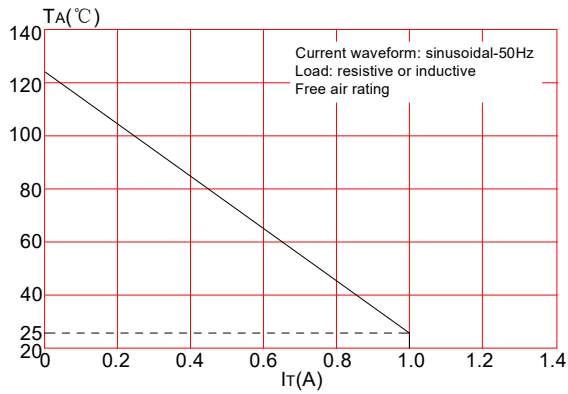

FIG.2: Reflow condition

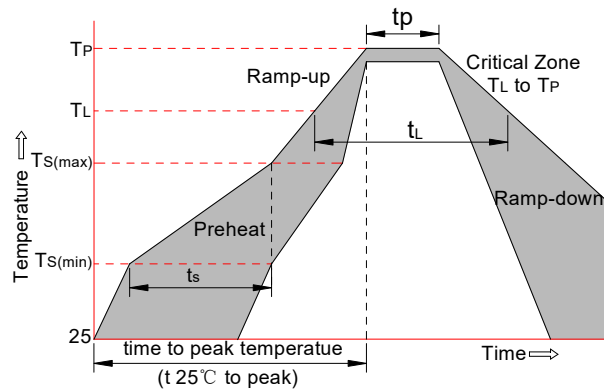

FIG.3: Normalized Vs change vs. junction temperature

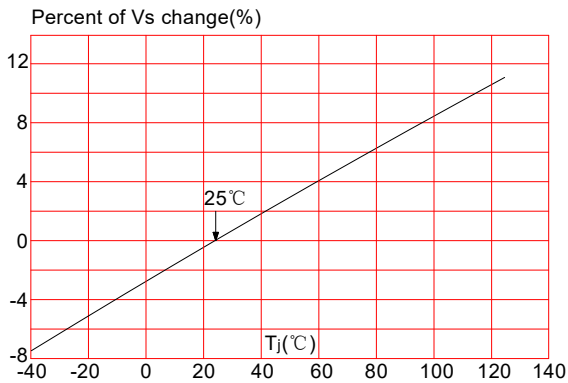
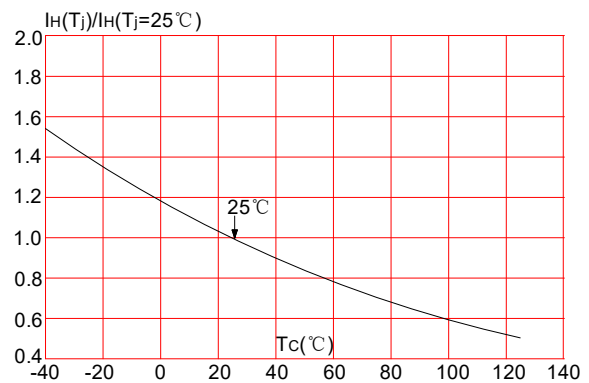

FIG.4: Normalized DC holding current vs. case temperature



PACKAGE MECHANICAL DATA

<p style="text-align: center;">DO-15</p>	Dimensions				
	Ref.	Millimeters		Inches	
		Min.	Max.	Min.	Max.
A	25.40	-	1.000	-	
B	5.80	7.62	0.228	0.300	
C	0.71	0.86	0.028	0.034	
D	2.60	3.60	0.102	0.142	

TAPE AND BOX SPECIFICATION-DO-15

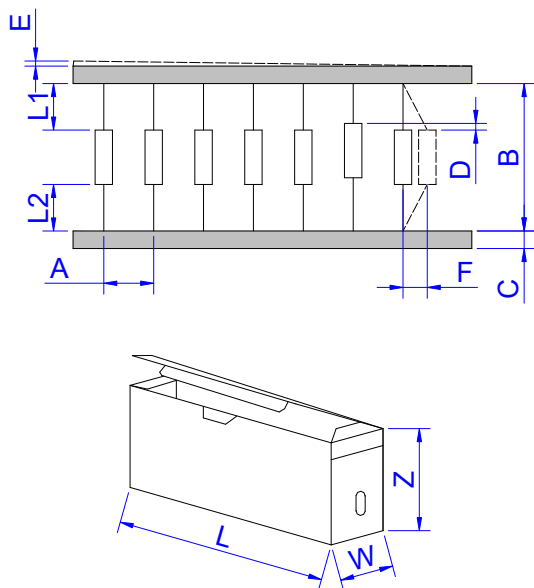

Ref.	Dimensions	
	Millimeters	Inches
A	5.0±0.5	0.197±0.020
B	53.0±1.5	2.087±0.059
C	6.0±0.5	0.236±0.020
D	1.2(MAX)	0.047(MAX)
E	0.8(MAX)	0.031(MAX)
F	1.5(MAX)	0.059(MAX)
L1-L2	1.0(MAX)	0.039(MAX)
W	80±5.0	3.150±0.197
L	250±5.0	9.843±0.197
Z	115±5.0	4.528±0.197

PART No.	UNIT WEIGHT (g/PCS) typ.	PER BOX (PCS)	PER CARTON (PCS)	DESCRIPTION
KxxxxG	0.42	2,000	20,000	Box

JieJie products are not designed for, and shall not be used for, any purpose (including, without limitation, automotive, military, aerospace, medical, life-saving, life-sustaining or nuclear facility applications, devices intended for surgical implant into the body, or any other application in which the failure or lack of desired operation of the product may result in personal injury, death, or property damage) other than those expressly set forth in applicable JieJie product documentation. Warranties granted by JieJie shall be deemed void for products used for any purpose not expressly set forth in applicable JieJie documentation. JieJie shall not be liable for any claims or damages arising out of products used in applications not expressly intended by JieJie as set forth in applicable JieJie documentation. The sale and use of JieJie products is subject to JieJie terms and conditions of sale, unless otherwise agreed by JieJie.

Information furnished in this document is believed to be accurate and reliable.

However, Jiangsu JieJie Microelectronics Co.,Ltd assumes no responsibility for the consequences of use without consideration for such information nor use beyond it.

Information mentioned in this document is subject to change without notice, apart from that when an agreement is signed, Jiangsu JieJie complies with the agreement.

Products and information provided in this document have no infringement of patents. Jiangsu JieJie assumes no responsibility for any infringement of other rights of third parties which may result from the use of such products and information.

This document is the 3.1st version which is made in 12-July-2022. This document supersedes and replaces all information previously supplied.



is a registered trademark of Jiangsu JieJie Microelectronics Co.,Ltd.

Copyright ©2022 Jiangsu JieJie Microelectronics Co.,Ltd. Printed All rights reserved.