



# XH CONNECTOR

2.5mm pitch/Disconnectable Crimp style connectors



The XH connector was developed based on the high reliability and versatility of our NH series connectors. The connector is very small with a mounting height of 9.8mm.

- Original folded beam contact
- Box-shaped shrouded header
- Header with a boss
- Interchangeability
- Conforming to the HA terminal

## Specifications

- Current rating: 3 A AC, DC (AWG #22)
  - Voltage rating: 250 V AC, DC
  - Temperature range: -25°C to +85°C  
(including temperature rise in applying electrical current)
  - Contact resistance: Initial value/ 10 mΩ max.  
After environmental tests/ 20 mΩ max.
  - Insulation resistance: 1,000 MΩ min.
  - Withstanding voltage: 1,000 VAC/minute
  - Applicable wire: AWG #30 to #22
  - Applicable PC board thickness: 1.6 mm
- \* Refer to "General Instruction and Notice when using Terminals and Connectors" at the end of this catalog.  
\* Contact JST for details.  
\* Compliant with RoHS.

## Standards

- Ⓜ Recognized E60389
- Ⓢ Certified LR20812
- ⚠ J50014297

## PC board layout and Assembly layout

### <Through-hole type (viewed from soldering side)>

#### Top entry type

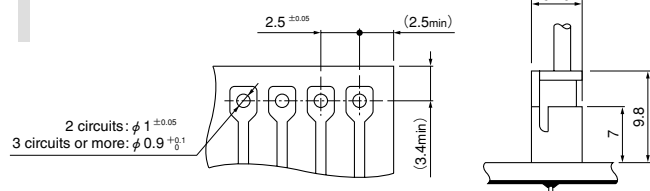

#### Side entry type

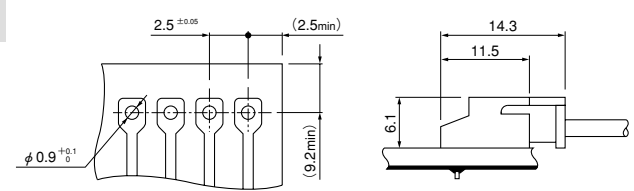

#### Top entry type with a boss <Single circuit>

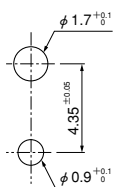

#### <2 circuits or more>

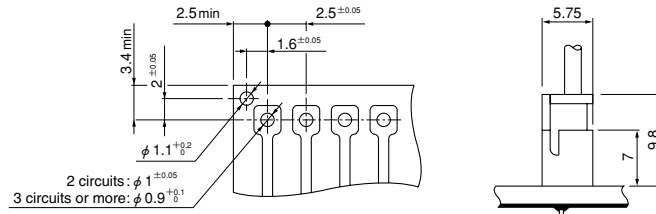

Note: 1. Tolerances are non-cumulative: ±0.05 mm for all centers.

2. Hole dimensions differ according to the type of PC board and piercing method. If PC boards made of hard material are used, the hole dimensions should be larger. The dimensions above should serve as a guideline. Contact JST for details.

### <SMT type (viewed from component side)>

#### Side entry type

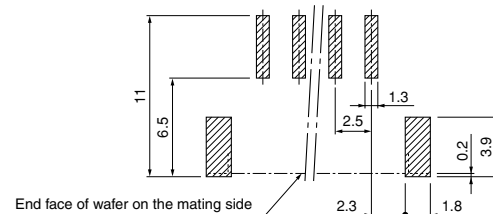

Note: 1. Tolerances are non-cumulative: ±0.05 mm for all centers.

2. The dimensions above should serve as a guideline. Contact JST for details.

# XH CONNECTOR

## Contact

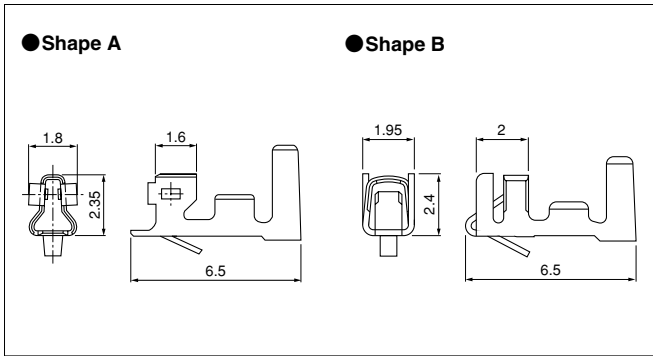

Contact	Crimping machine	Applicator		
		Crimp applicator	Dies	Crimp applicator with dies
SXH-001T-P0.6N	AP-K2N	MKS-L	MK/SXH-001-06N	APLMK SXH001-06N
		*MKS-SC	SC/SXH-001-06N	APLSC SXH001-06N
SXH-001T-P0.6	AP-K2N	MKS-L	MK/SXH-001-06	APLMK SXH001-06
		*MKS-SC	SC/SXH-001-06	APLSC SXH001-06

Note: \*Strip-crimp applicator

Model No.	Shape	Applicable Wire		Insulation O.D (mm)	Q'ty/reel
		mm <sup>2</sup>	AWG#		
SXH-001T-P0.6N	A	0.13~0.33	26~22	1.3~1.9	5,000
SXH-001T-P0.6	B	0.08~0.33	28~22	0.9~1.9	8,000
SXH-002T-P0.6		0.05~0.13	30~26	0.9~1.3	

### Material and Finish

Phosphor bronze, tin-plated (reflow treatment)

### RoHS compliance

Note:

- Contact JST if you require gold-plated contacts or contacts made of brass.
- Contact JST also if you require shielded wires, thin wires or other special wires.
- SXH-001T-P0.6N is low-insertion force type contact, for easier insertion/withdrawal, which would be less resistant to the vibration.

Contact	Crimping machine	Applicator		
		Crimp applicator	Dies	Crimp applicator with dies
SXH-002T-P0.6	AP-K2N	MKS-L	MK/SXH-002-06	APLMK SXH002-06
		*MKS-SC	SC/SXH-002-06	APLSC SXH002-06

## Housing

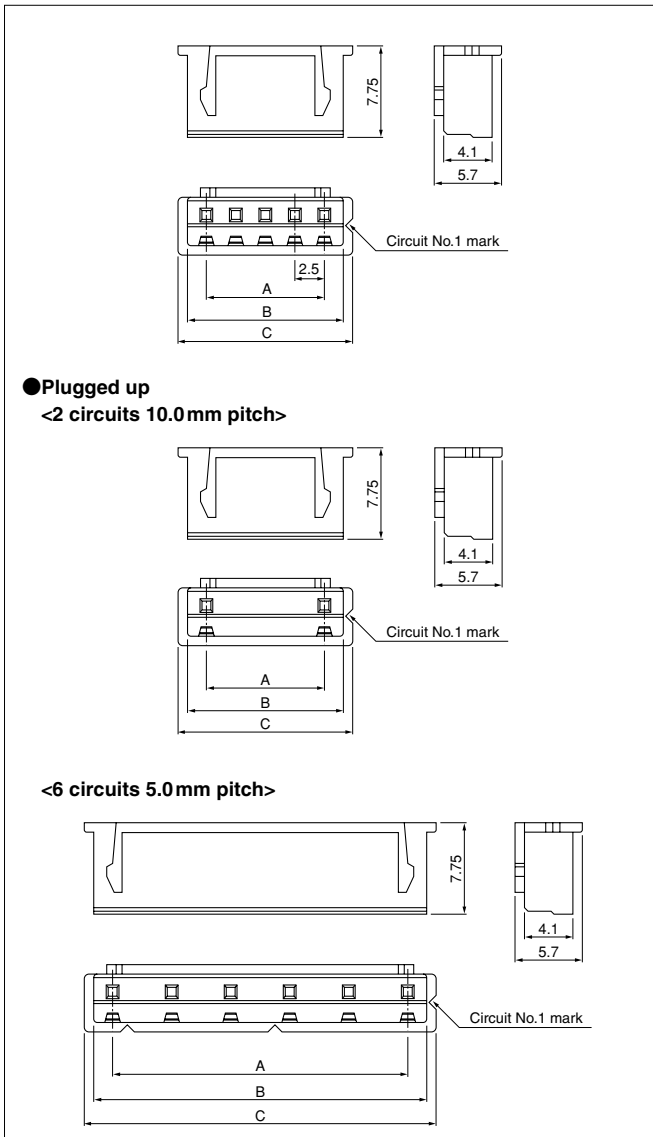

Circuits	Model No.	Dimensions (mm)			Q'ty/bag
		A	B	C	
1	XHP-1	—	3.2	4.8	1,000
2	XHP-2	2.5	5.7	7.3	1,000
2	XHP-2(10.0)-U	10.0	13.2	14.8	1,000
3	XHP-3	5.0	8.2	9.8	1,000
4	XHP-4	7.5	10.7	12.3	1,000
5	XHP-5	10.0	13.2	14.8	1,000
6	XHP-6	12.5	15.7	17.3	1,000
6	XHP-6(5.0)-U	25.0	28.2	29.8	1,000
7	XHP-7	15.0	18.2	19.8	1,000
8	XHP-8	17.5	20.7	22.3	1,000
9	XHP-9	20.0	23.2	24.8	1,000
10	XHP-10	22.5	25.7	27.3	1,000
11	XHP-11	25.0	28.2	29.8	1,000
12	XHP-12	27.5	30.7	32.3	1,000
13	XHP-13	30.0	33.2	34.8	1,000
14	XHP-14	32.5	35.7	37.3	1,000
15	XHP-15	35.0	38.2	39.8	1,000
16	XHP-16	37.5	40.7	42.3	1,000
20	XHP-20	47.5	50.7	52.3	500

### Material

PA 6, UL94V-0, natural (white)

### RoHS compliance

Note:

- XHP-2(10.0)-U is 2 circuits 10.0mm pitch plugged up. Not UL/CSA/TÜV approved.
- XHP-6(5.0)-U is 6 circuits 5.0mm pitch plugged up. Not UL/CSA/TÜV approved.

<For reference> As the color identification, the following alphabet shall be put in the underlined part. For availability, delivery and minimum order quantity, contact JST.

ex. **XHP-1-oo**  
(blank)...natural (white)  
BK...black R...red E...blue Y...yellow L...lemon yellow  
M...green D...orange N...brown FY...vivid yellow

<Plugged up type>

ex. **XHP-2(10.0)-U-oo**  
(blank)...natural (white)  
R...red E...blue

# XH CONNECTOR

## Through-hole type shrouded header

The shrouded headers are interchangeable with those of the NR and NRD insulation displacement connectors, and JQ board-to-board connectors.



Circuits	Model No.			Dimensions (mm)		Q'ty/box	
	Top entry type	Side entry type		A	B	Top entry type	Side entry type
2	B2B-XH-A	S2B-XH-A-1	S2B-XH-A	2.5	7.4	1,000	1,000
2	B2(10.0)B-XH-A-U	—	—	10.0	14.9	1,000	—
3	B3B-XH-A	S3B-XH-A-1	S3B-XH-A	5.0	9.9	1,000	1,000
4	B4B-XH-A	S4B-XH-A-1	S4B-XH-A	7.5	12.4	500	500
5	B5B-XH-A	S5B-XH-A-1	S5B-XH-A	10.0	14.9	500	500
6	B6B-XH-A	S6B-XH-A-1	S6B-XH-A	12.5	17.4	500	500
7	B7B-XH-A	S7B-XH-A-1	S7B-XH-A	15.0	19.9	500	250
8	B8B-XH-A	S8B-XH-A-1	S8B-XH-A	17.5	22.4	250	250
9	B9B-XH-A	S9B-XH-A-1	S9B-XH-A	20.0	24.9	250	250
10	B10B-XH-A	S10B-XH-A-1	S10B-XH-A	22.5	27.4	250	250
11	B11B-XH-A	S11B-XH-A-1	S11B-XH-A	25.0	29.9	250	250
12	B12B-XH-A	S12B-XH-A-1	S12B-XH-A	27.5	32.4	250	200
13	B13B-XH-A	S13B-XH-A-1	S13B-XH-A	30.0	34.9	250	200
14	B14B-XH-A	S14B-XH-A-1	S14B-XH-A	32.5	37.4	250	200
15	B15B-XH-A	S15B-XH-A-1	S15B-XH-A	35.0	39.9	250	100
16	B16B-XH-A	—	S16B-XH-A	37.5	42.4	200	100
20	B20B-XH-A	—	—	47.5	52.4	100	—

### Material and Finish

Post: Brass, copper-undercoated, tin-plated (reflow treatment)  
Wafer: PA 66, UL94V-0, natural (white)

**RoHS compliance** This product displays (LF)(SN) on a label.

Note: B2(10.0)B-XH-A-U is 2 circuits 10.0mm pitch plugged up.

Not UL/CSA/TÜV approved.

<For reference> As the color identification, the following alphabet shall be put in the underlined part.  
For availability, delivery and minimum order quantity, contact JST.

ex. **S3B-XH-A(1)-oo**

(blank)...natural (white)

BK...black R...red E...blue Y...yellow L...lemon yellow

M...green D...orange N...brown FY...vivid yellow

## Through-hole type shrouded header



Circuits	Model No.	Dimensions (mm)		Q'ty/bag
		A	B	
2	B2B-XH-2	2.5	7.4	1,000
3	B3B-XH-2	5.0	9.9	1,000
4	B4B-XH-2	7.5	12.4	500
5	B5B-XH-2	10.0	14.9	500
6	B6B-XH-2	12.5	17.4	500
7	B7B-XH-2	15.0	19.9	500
8	B8B-XH-2	17.5	22.4	250
9	B9B-XH-2	20.0	24.9	250
10	B10B-XH-2	22.5	27.4	250
11	B11B-XH-2	25.0	29.9	250
12	B12B-XH-2	27.5	32.4	250
13	B13B-XH-2	30.0	34.9	250
14	B14B-XH-2	32.5	37.4	250
15	B15B-XH-2	35.0	39.9	250

### Material and Finish

Post: Brass, copper-undercoated, tin-plated (reflow treatment)  
Wafer: Glass-filled PA 66, UL94V-0, natural (ivory)

**RoHS compliance** This product displays (LF)(SN) on a label.

<For reference> As the color identification, the following alphabet shall be put in the underlined part.  
For availability, delivery and minimum order quantity, contact JST.

ex. **B2B-XH-2-oo**

(blank)...natural (ivory)

C...black R...red E...blue Y...yellow M...green

## Through-hole type shrouded header

The shrouded headers are interchangeable with those of the NR and NRD insulation displacement connectors, and JQ board-to-board connectors.

### Top entry type with a boss

#### <Single circuit>



#### <2 circuits>



#### <3 circuits or more>

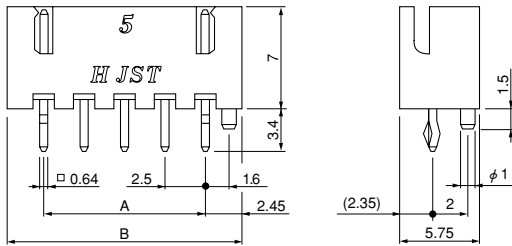

Circuits	Model No.	Dimensions (mm)		Q'ty/box
		A	B	
1	<b>*B1B-XH-AM</b>	—	—	1,000
2	<b>B2B-XH-AM</b>	2.5	7.4	1,000
3	<b>B3B-XH-AM</b>	5.0	9.9	1,000
4	<b>B4B-XH-AM</b>	7.5	12.4	500
5	<b>B5B-XH-AM</b>	10.0	14.9	500
6	<b>B6B-XH-AM</b>	12.5	17.4	500
7	<b>B7B-XH-AM</b>	15.0	19.9	500
8	<b>B8B-XH-AM</b>	17.5	22.4	250
9	<b>B9B-XH-AM</b>	20.0	24.9	250
10	<b>B10B-XH-AM</b>	22.5	27.4	250
12	<b>B12B-XH-AM</b>	27.5	32.4	250

#### Material and Finish

Post: Brass, copper-undercoated, tin-plated (reflow treatment)  
Wafer: PA 66, UL94V-0, natural (white)

**RoHS compliance** This product displays (LF)(SN) on a label.  
Note: \*Marked product is not approved by UL/CSA/TÜV standards.

<For reference> As the color identification, the following alphabet shall be put in the underlined part.  
For availability, delivery and minimum order quantity, contact JST.

ex. **B1B-XH-AM-oo**

(blank)...natural (white)

BK...black R...red E...blue Y...yellow L...lemon yellow

M...green

## SMT type shrouded header



Circuits	Model No.	Dimensions (mm)		Q'ty/reel
		A	B	
3	<b>S3B-XH-SM4-TB</b>	5.0	12.5	500
4	<b>S4B-XH-SM4-TB</b>	7.5	15.0	500
6	<b>S6B-XH-SM4-TB</b>	12.5	20.0	500

#### Material and Finish

Post: Copper alloy, copper-undercoated, tin-plated (reflow treatment)  
Wafer: PA 6T, UL94V-0, natural (ivory)  
Solder tab: Brass, copper-undercoated, tin-plated (reflow treatment)

**RoHS compliance** This product displays (LF)(SN) on a label.  
Note: The products listed above are supplied on embossed-tape.

<For reference> As the color identification, the following alphabet shall be put in the underlined part.  
For availability, delivery and minimum order quantity, contact JST.

ex. **S3B-XH-SM4-oo-TB**

(blank)...natural (ivory)

M...green R...red E...blue L...lemon yellow

# XH CONNECTOR

## Through-hole type shrouded header on radial-tape



Circuits	Model No.		Dimensions (mm)		Q'ty/ box
	TV4	2-TV4	A	B	
2	—	<b>B2B-XH-2-TV4</b>	—	—	1,000
3	<b>B3B-XH-TV4</b>	<b>B3B-XH-2-TV4</b>	5.0	9.9	1,000
4	<b>B4B-XH-TV4</b>	<b>B4B-XH-2-TV4</b>	7.5	12.4	500
5	—	<b>B5B-XH-2-TV4</b>	10.0	14.9	500
6	—	<b>B6B-XH-2-TV4</b>	12.5	17.4	500
7	—	<b>B7B-XH-2-TV4</b>	15.0	19.9	500
8	—	<b>B8B-XH-2-TV4</b>	17.5	22.4	500

### Material and Finish

Post: Brass, copper-undercoated, tin-plated (reflow treatment)  
 Wafer: TV4 type/ PA 66, UL94V-0, natural (white)  
 2-TV4 type/ Glass-filled PA 66, UL94V-0, natural (ivory)

**RoHS compliance** This product displays (LF)(SN) on a label.

<For reference> As the color identification, the following alphabet shall be put in the underlined part. For availability, delivery and minimum order quantity, contact JST.

ex. **B2B-XH-2-TV4-oo**

(blank)...natural (TV4 type/white, 2-TV4 type/ivory)

C...black (glass-filled) BK...black R...red E...blue Y...yellow M...green

## Taping specification



Note: Conforms to JIC C 0806 of "Tape packaging of components with unidirectional leads on continuous tapes".

## Packaging specifications



Package type	Flat pack (zigzag folded)	
Distance between folds	24 indexing holes per fold (304.8 mm)	
Box size	316(W)×45(D)×330(H) mm	
Distance between the end of the tape and the first connector's center line (either end)	19.05 mm	
Quantity	2, 3 circuits	1,000 pcs. / box
	4~8 circuits	500 pcs. / box

Note: Products of different packaging specifications are also available. Contact JST for details.