

目錄
MAPX

變更內容
MODIFICATION

日期
DATE

ORDER INFORMATION:

Q2T 22

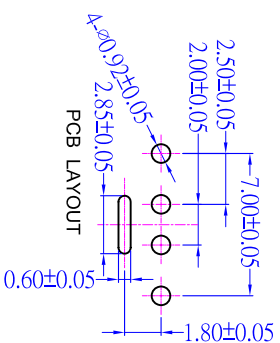
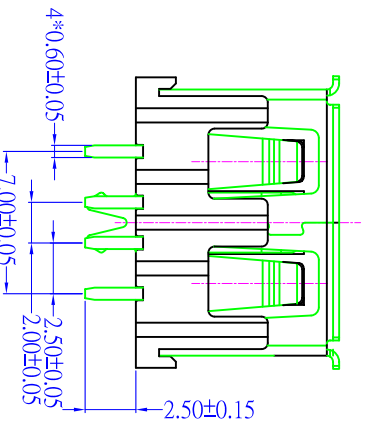
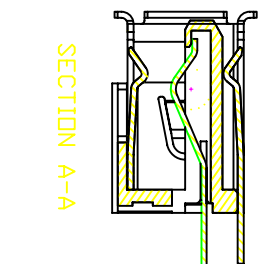
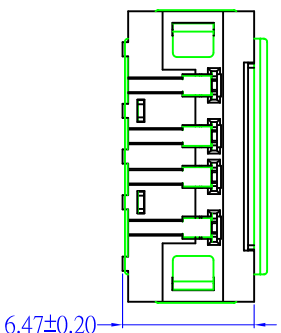
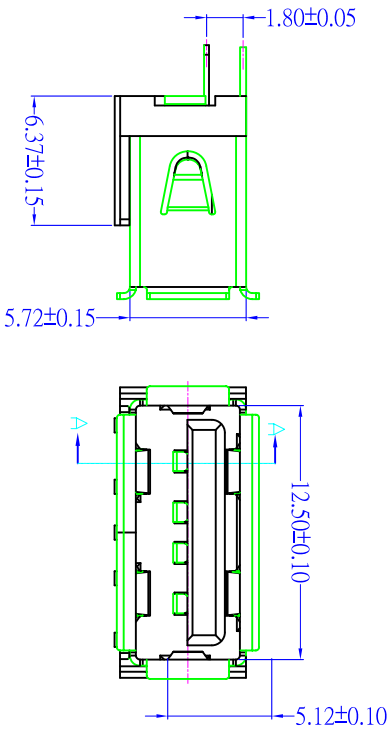
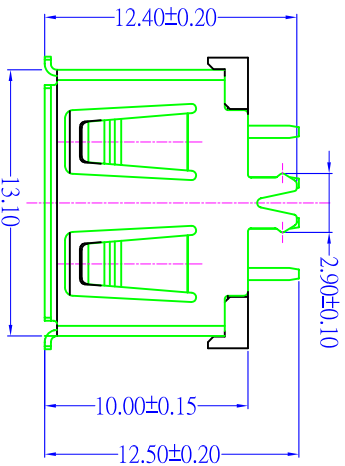
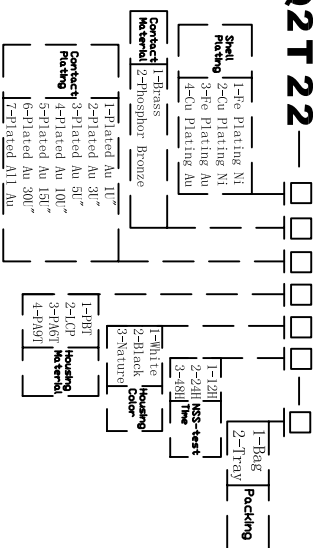

ELECTRICAL CHARACTERISTICS:
 Temperature Range : -20° C to +85° C
 Voltage Current Rating : 1AMP, 30V AC
 Insulation Resistance : 1000M OHM Min
 Contact Resistance : 30m OHM Max
 Dielectric Withstanding Voltage : 500V AC
 Mechanical:
 Mating Force: 3.57 Kgf MAX
 Umating Force: 1.02 Kgf MIN.

深圳市精拓金电子有限公司

产品图 PRODUCT CHART DWG		单位 UNITS		制图 DRAWING		产品料号 PRODUCT PART NO.	
公差一览表 TOLERANCE UNLESS OTHERWISE		MM		Z-Y-B			
X	±0.25	X	±5°	审核 CHECK	雷永键	产品名称 PRODUCT NAME	USB-A/F10MM短体180度侧边鱼叉脚
.X	±0.20	.X	±2°	核准 APPD	雷永键	角法 VIEW	
.XX	±0.15	.XX	±1°	日期 DATE	2013.05.10	版本 VERS	A0
.XXX	±0.10	.XXX	±0.5°				