

DATA SHEET

**ELECTROSTATIC DISCHARGE
PROTECTION DEVICES**

INDUSTRIAL / CONSUMER

LBT23C12L02

RoHS compliant & Halogen free



Product specification— March 21, 2021 V.2



Electrostatic Discharged Protection Devices (ESD) Data Sheet

Description

Brightking's LBT23C12L02 component is designed to protect sensitive electronics from damage or latch-up due to ESD and other voltage induced transient events. It is designed for use in applications where board space is at a premium. The device will protect up to two lines. It is bidirectional devices and may be used on lines where the signal polarities are above ground. TVS diodes are solid state device designed specifically for transient suppression. It feature large cross-sectional area junctions for conduction high transient currents. It offer desirable characteristics for board level protection including fast response time, low and clamping voltage, and no device degradation. The device may be used to meet the immunity requirements of IEC61000-4-2, level 4.



Contact : ±8kV
Air : ±15kV



Features

- IEC61000-4-2 ESD 15KV Air, 8KV contact compliance
- SOT-23 surface mount package
- Protects bidirectional two I/O lines
- Peak power dissipation of 100W under 8/20µs waveform
- Working voltage: 12V
- Low leakage current
- Low operating and clamping voltages
- Solid-state silicon avalanche technology
- Lead Free/RoHS compliant
- Solder reflow temperature: Pure Tin-Sn, 260~270°C
- Flammability rating UL 94V-0
- Meets MSL level 1, per J-STD-020
- Marking: B L12

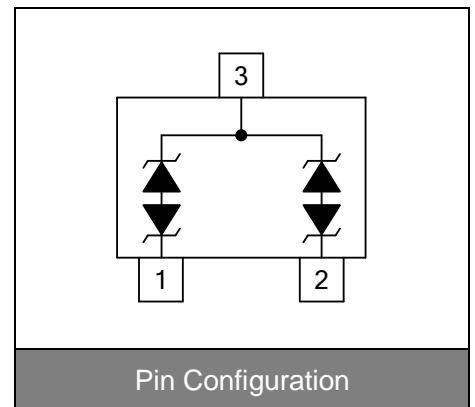

Applications

- Keypads, data lines, buttons
- Notebook computers
- Portable handheld devices
- Digital Cameras
- Portable GPS

Maximum Ratings

| Rating | Symbol | Value | Unit |
|---------------------------------------|-----------------------------------|----------|------|
| Peak pulse power (tp=8/20µs waveform) | P _{PP} | 100 | W |
| ESD voltage (Contact discharge) | V _{ESD} | ±8 | kV |
| ESD voltage (Air discharge) | | ±15 | |
| Storage & operating temperature range | T _{STG} , T _J | -55~+150 | °C |

Electrical Characteristics (T_J=25°C)

| Parameter | Symbol | Condition | Min. | Typ. | Max. | Unit |
|--------------------------------|------------------|--|------|------|------|------|
| Reverse stand-off voltage | V _{RWM} | | | | 12 | V |
| Reverse breakdown voltage | V _{BR} | I _{BR} =1mA | 13.3 | | | V |
| Reverse leakage current | I _R | V _R =12V Each I/O pin | | | 1 | μA |
| Clamping voltage (tp=8/20μs) | V _C | I _{PP} =1A | | | 23 | V |
| Clamping voltage (tp=8/20μs) | V _C | I _{PP} =3A | | | 28 | V |
| Peak pulse current (tp=8/20μs) | I _{PP} | | | | 3 | A |
| Off state junction capacitance | C _J | 0Vdc, f=1MHz Between I/O pins and GND | | 8 | 15 | pF |

Typical Characteristics Curves

Figure 1. Power Derating Curve

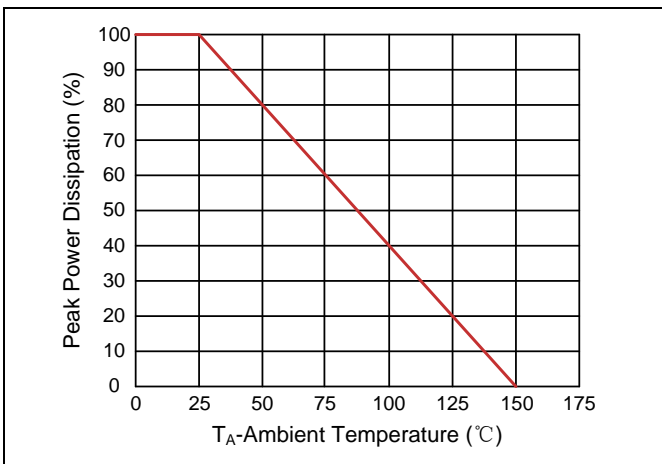

Figure 2. Pulse Waveforms

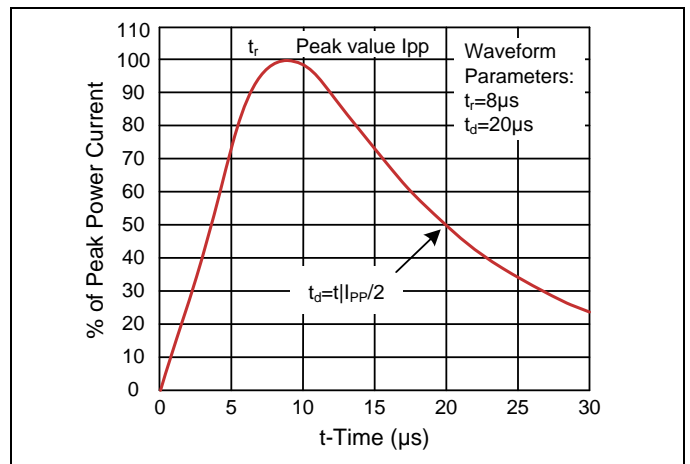

Figure 3. Clamping Voltage vs. Peak Pulse Current

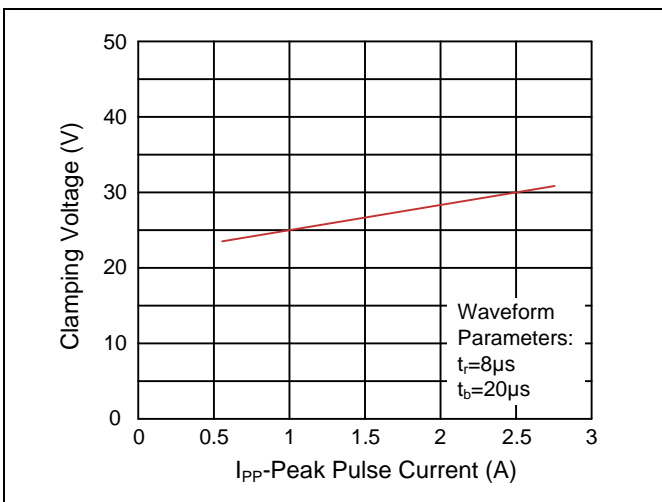
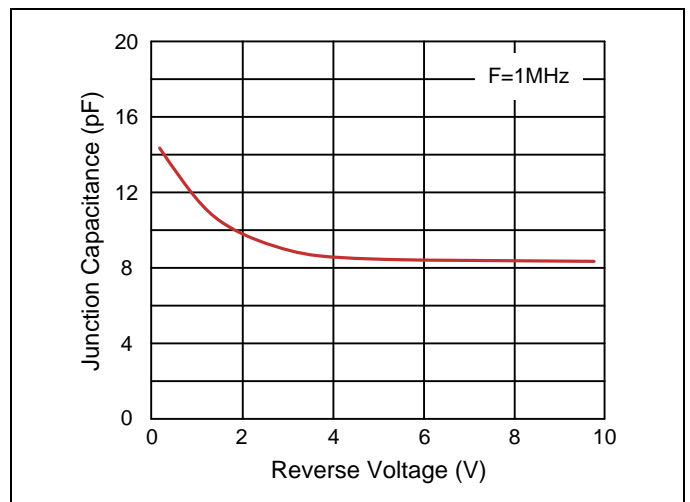
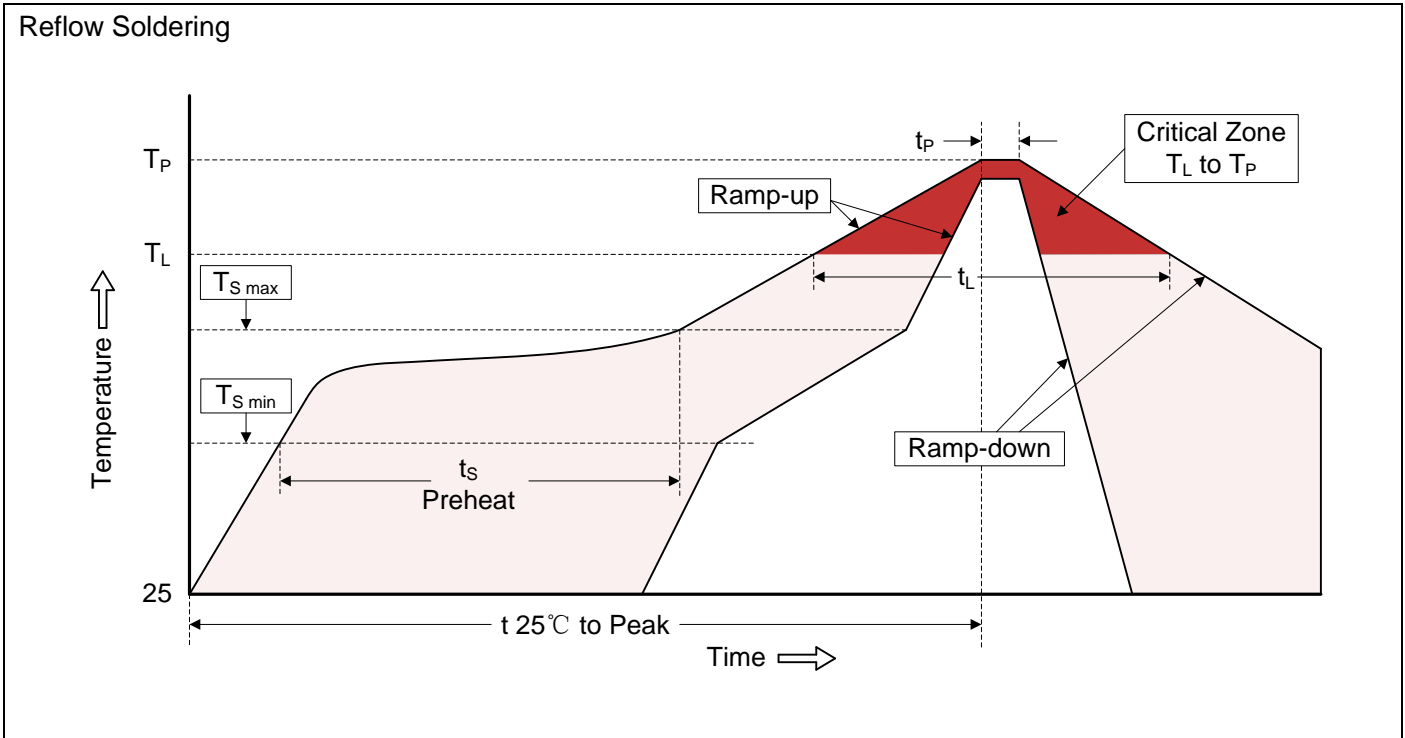

Figure 4. Normalized Capacitance vs. Reverse Voltage



Recommended Soldering Conditions



Recommended Conditions

| Profile Feature | Pb-Free Assembly |
|---|----------------------------------|
| Average ramp-up rate (T_L to T_P) | 3°C/second max. |
| Preheat -Temperature Min ($T_{S\ min}$) -Temperature Max ($T_{S\ max}$) -Time (min to max) (t_s) | 150°C 200°C 60-180 seconds |
| $T_{S\ max}$ to T_L -Ramp-up Rate | 3°C/second max. |
| Time maintained above: -Temperature (T_L) -Time (t_L) | 217°C 60-150 seconds |
| Peak Temperature (T_P) | 260°C |
| Time within 5°C of actual Peak Temperature (t_P) | 20-40 seconds |
| Ramp-down Rate | 6°C/second max. |
| Time 25°C to Peak Temperature | 8 minutes max. |

Dimensions (SOT-23)

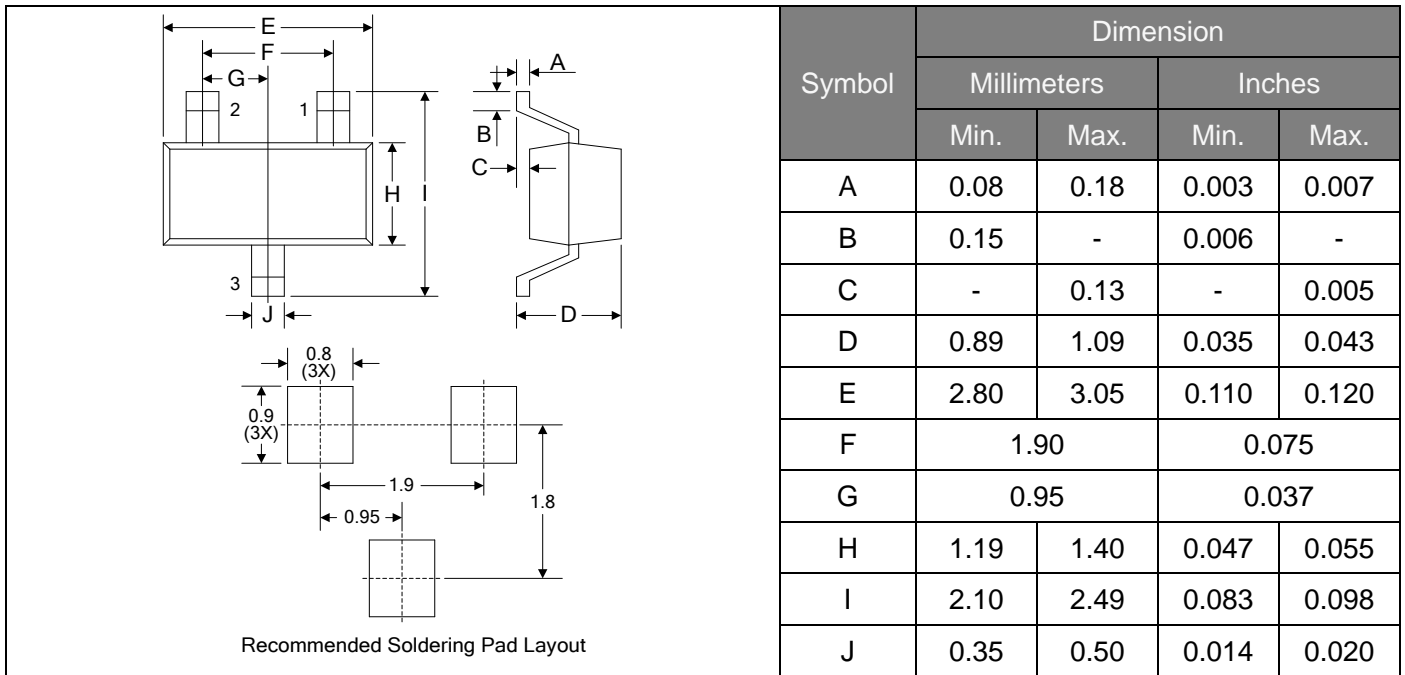

Packaging

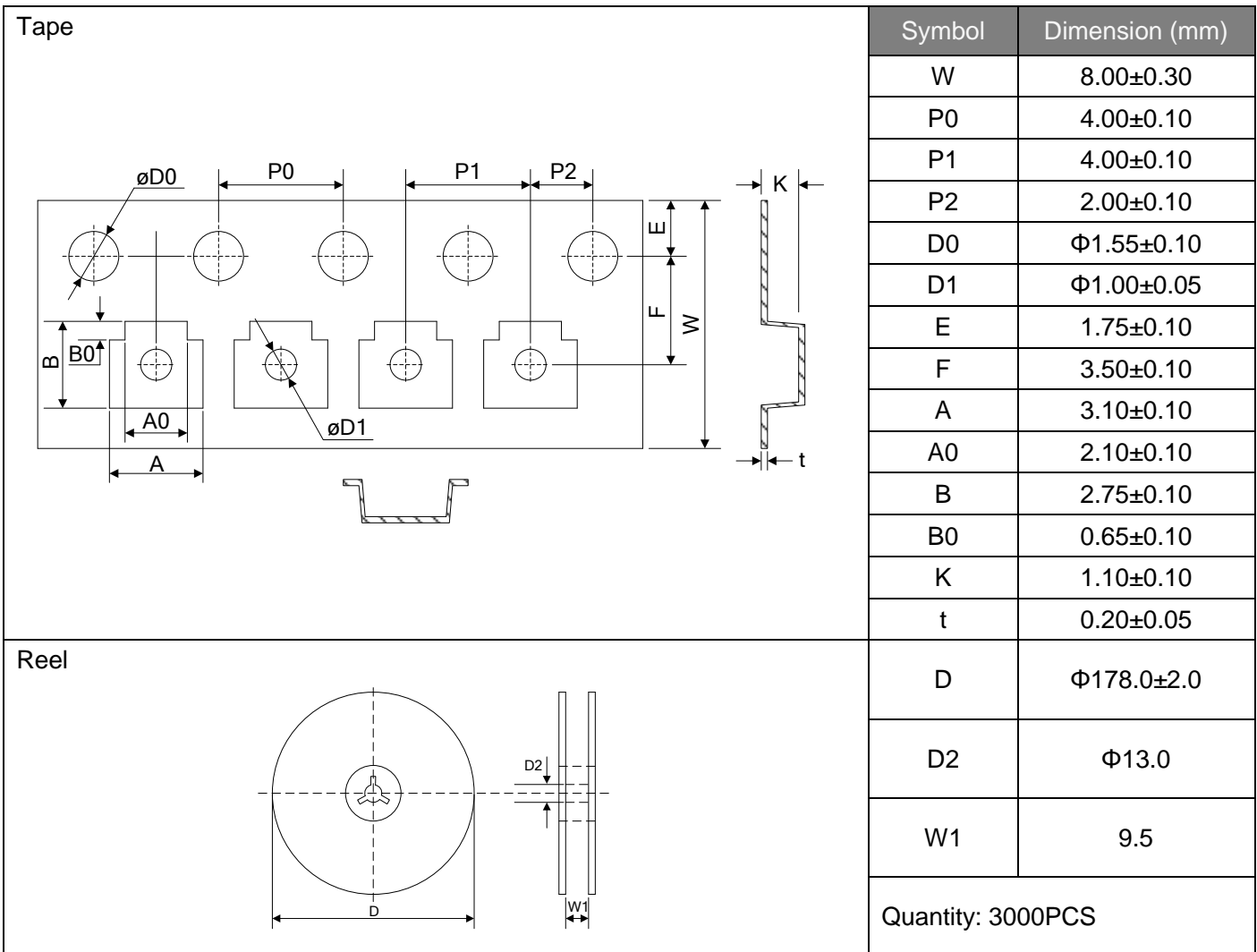

Mouser Electronics

Authorized Distributor

Click to View Pricing, Inventory, Delivery & Lifecycle Information:

[YAGEO:](#)

[LBT23C12L02](#)