

General Purpose Transistors

Pb-Free package is available

S- Prefix for Automotive and Other Applications Requiring Unique Site and Control Change Requirements; AEC-Q101 Qualified and PPAP Capable.

L2SC1623QLT1G
Series
S-L2SC1623QLT1G
Series

DEVICE MARKING AND ORDERING INFORMATION

Device	Marking	Shipping
L2SC1623QLT1G S-L2SC1623QLT1G	L5	3000/Tape&Reel
L2SC1623QLT3G S-L2SC1623QLT3G	L5	10000/Tape&Reel
L2SC1623RLT1G S-L2SC1623RLT1G	L6	3000/Tape&Reel
L2SC1623RLT3G S-L2SC1623RLT3G	L6	10000/Tape&Reel
L2SC1623SLT1G S-L2SC1623SLT1G	L7	3000/Tape&Reel
L2SC1623SLT3G S-L2SC1623SLT3G	L7	10000/Tape&Reel

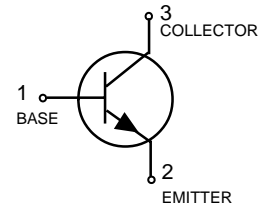
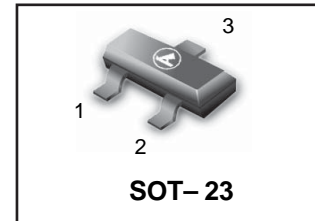

MAXIMUM RATINGS

Rating	Symbol	Value	Unit
Collector-Emitter Voltage	V_{CEO}	50	V
Collector-Base Voltage	V_{CBO}	60	V
Emitter-Base Voltage	V_{EBO}	7	V
Collector current-continuoun	I_C	150	mAdc

THERMAL CHARATEERISTICS

Characteristic	Symbol	Max	Unit
Total Device Dissipation FR-5 Board, (1) $T_A=25^\circ\text{C}$ Derate above 25°C	P_D	225 1.8	mW mW/ $^\circ\text{C}$
Thermal Resistance, Junction to Ambient	$R_{\theta JA}$	556	$^\circ\text{C}/\text{W}$
Total Device Dissipation Alumina Substrate, (2) $T_A=25^\circ\text{C}$ Derate above 25°C	P_D	300 2.4	mW mW/ $^\circ\text{C}$
Thermal Resistance, Junction to Ambient	$R_{\theta JA}$	417	$^\circ\text{C}/\text{W}$
Junction and Storage Temperature	T_J, T_{stg}	-55 to +150	$^\circ\text{C}$

DEVICE MARKING

L2SC1623QLT1G=L5 L2SC1623RLT1G=L6 L2SC1623SLT1G=L7

ELECTRICAL CHARACTERISTICS ($T_A=25^\circ\text{C}$ unless otherwise noted)

Characteristic	Symbol	Min	Typ	Max	Unit
----------------	--------	-----	-----	-----	------

OFF CHARACTERISTICS

Collector Cutoff Current ($V_{CB}=60\text{V}$)	I_{CBO}	-	-	0.1	μA
Emitter Cutoff Current ($V_{BE}=5\text{V}$)	I_{EBO}	-	-	0.1	μA

L2SC1623QLT1G
Series
S-L2SC1623QLT1G
Series

ON CHARACTERISTICS

DC Current Gain ($I_C=1.0\text{mA}$, $V_{CE}=6\text{V}$)	h_{FE}	120	-	560	
Collector-Emitter Saturation Voltage ($I_C=100\text{mA}$, $I_B=10\text{mA}$)	$V_{CE(sat)}$	-	0.15	0.3	V
Base-Emitter Saturation Voltage ($I_C=100\text{mA}$, $I_B=10\text{mA}$)	$V_{BE(sat)}$	-	0.86	1.0	V
Base -Emitter On Voltage ($I_C=1\text{mA}$, $V_{CE}=6.0\text{V}$)	V_{BE}	0.55	0.62	0.65	V

SMALL-SIGNAL CHARACTERISTICS

Current-Gain-Bandwidth Product ($V_{CE}=6.0\text{V}$, $I_E=-10\text{mA}$)	F_t	-	250	-	MHz
Output Capacitance($V_{CE}=6\text{V}$, $I_E=0$, $f=1.0\text{MHz}$)	C_{ob}	-	3	-	Pf

h_{FE} Values are classified as follows

NOTE:

*	Q	R	S
h_{FE}	120~270	180~390	270~560

L2SC1623QLT1G
Series
S-L2SC1623QLT1G
Series

Fig.1 Grounded emitter propagation characteristics

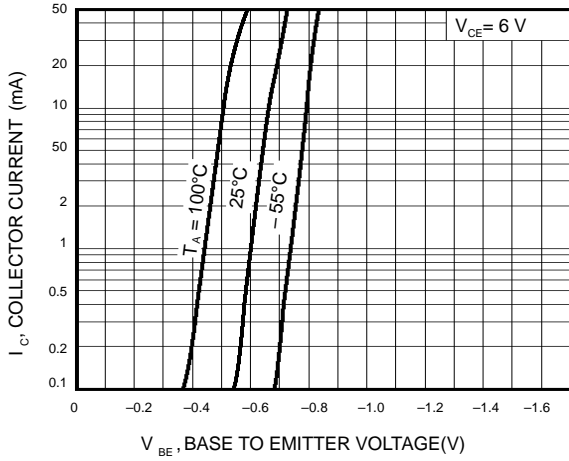

Fig.2 Grounded emitter output characteristics(I)

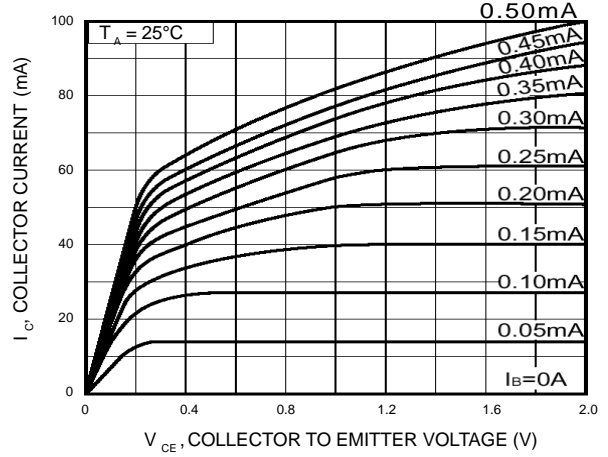

Fig.3 Grounded emitter output characteristics(II)

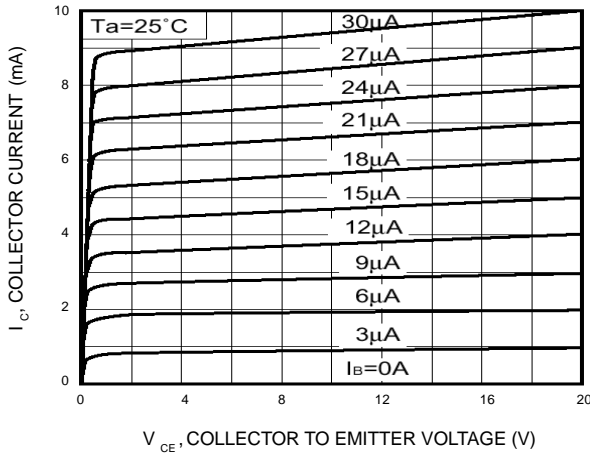

Fig.4 DC current gain vs. collector current (I)

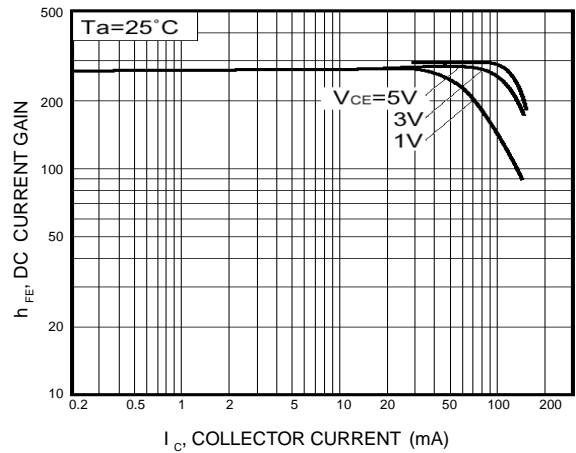

Fig.5 DC current gain vs. collector current (II)

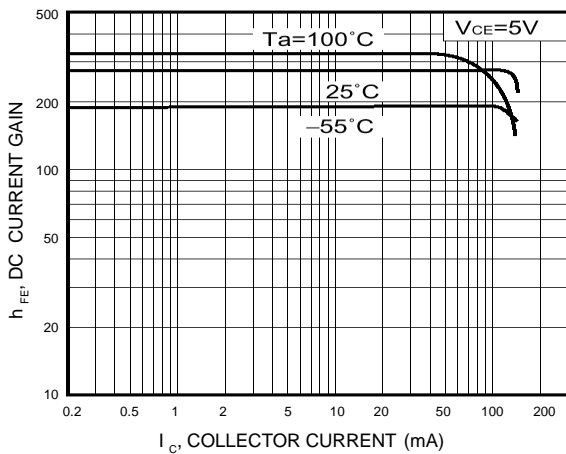
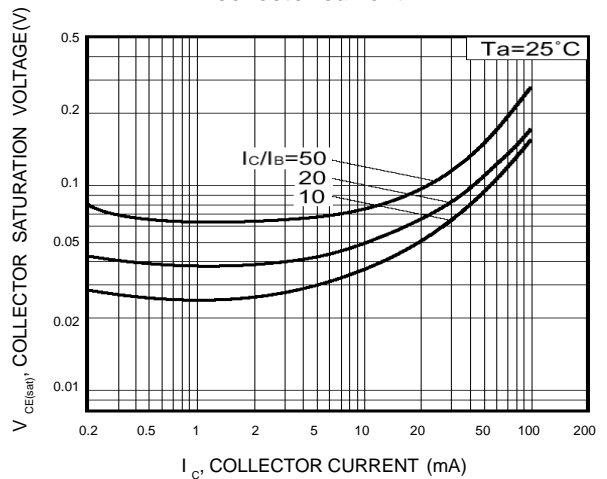

Fig.6 Collector-emitter saturation voltage vs. collector current



L2SC1623QLT1G
Series
S-L2SC1623QLT1G
Series

Fig.7 Collector-emitter saturation voltage vs. collector current (I)

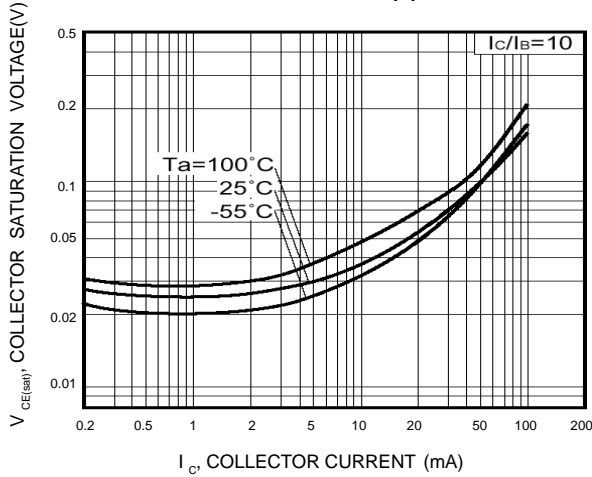

Fig.8 Collector-emitter saturation voltage vs. collector current (II)

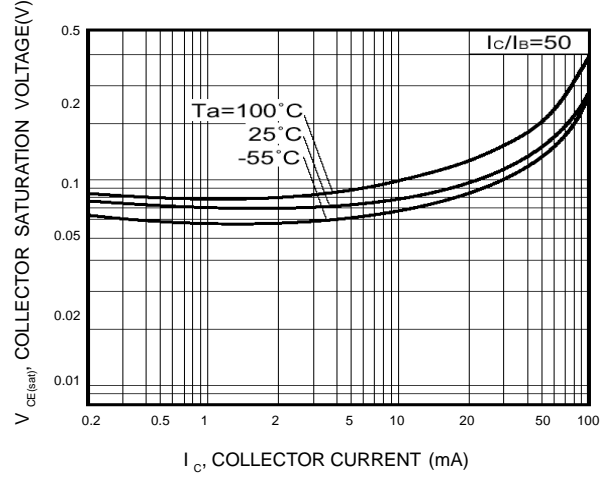

Fig.9 Gain bandwidth product vs. emitter current

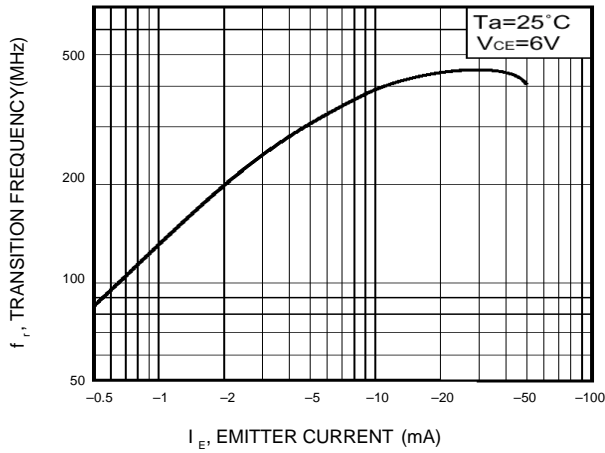

Fig.10 Collector output capacitance vs. collector-base voltage
Emitter input capacitance vs. emitter-base voltage

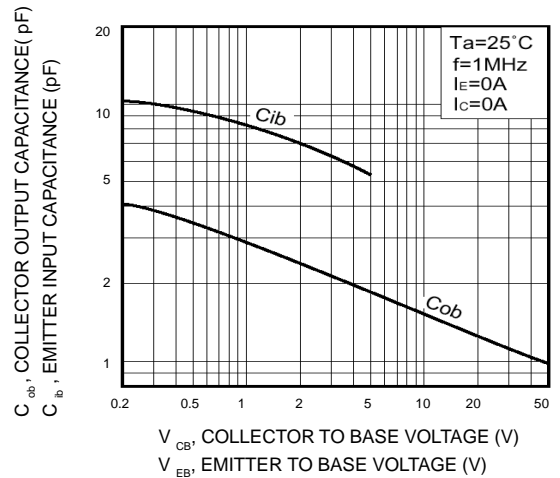
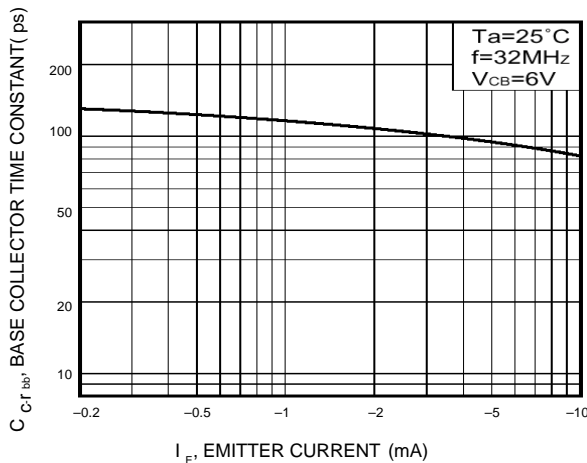
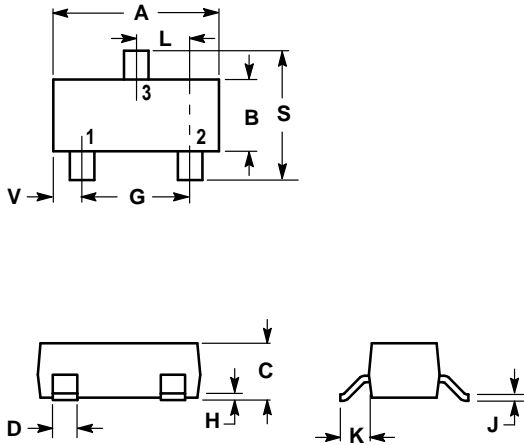

Fig.11 Base-collector time constant vs. emitter current



L2SC1623QLT1G
Series
S-L2SC1623QLT1G
Series

SOT-23



NOTES:

1. DIMENSIONING AND TOLERANCING PER ANSI Y14.5M, 1982.
2. CONTROLLING DIMENSION: INCH.

DIM	INCHES		MILLIMETERS	
	MIN	MAX	MIN	MAX
A	0.1102	0.1197	2.80	3.04
B	0.0472	0.0551	1.20	1.40
C	0.0350	0.0440	0.89	1.11
D	0.0150	0.0200	0.37	0.50
G	0.0701	0.0807	1.78	2.04
H	0.0005	0.0040	0.013	0.100
J	0.0034	0.0070	0.085	0.177
K	0.0140	0.0285	0.35	0.69
L	0.0350	0.0401	0.89	1.02
S	0.0830	0.1039	2.10	2.64
V	0.0177	0.0236	0.45	0.60

- PIN 1. BASE
2. EMITTER
3. COLLECTOR

