

L2SC2411KRLT1G

S-L2SC2411KRLT1G

General Purpose Transistors NPN Silicon

1. FEATURES

- We declare that the material of product compliance with RoHS requirements and Halogen Free.
- S- prefix for automotive and other applications requiring unique site and control change requirements; AEC-Q101 qualified and PPAP capable.

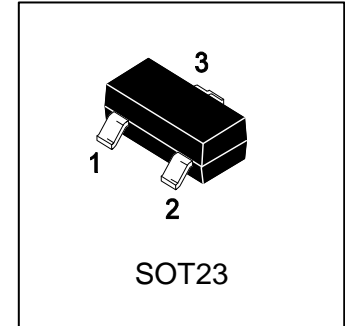

2. DEVICE MARKING AND ORDERING INFORMATION

Device	Marking	Shipping
L2SC2411KRLT1G	CR	3000/Tape&Reel
L2SC2411KRLT3G	CR	10000/Tape&Reel

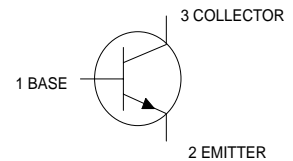

3. MAXIMUM RATINGS(Ta = 25°C)

Parameter	Symbol	Limits	Unit
Collector–Emitter Voltage	V _{CEO}	32	V _{dc}
Collector–Base Voltage	V _{CBO}	40	V _{dc}
Emitter–Base Voltage	V _{EB0}	5	V _{dc}
Collector Current — Continuous	I _C	500	mAdc

4. THERMAL CHARACTERISTICS

Parameter	Symbol	Limits	Unit
Total Device Dissipation, FR-5 Board (Note 1) @ TA = 25°C Derate above 25°C	PD	225 1.8	mW mW/°C
Thermal Resistance, Junction–to–Ambient(Note 1)	R _{θJA}	556	°C/W
Junction and Storage temperature	T _J , T _{stg}	-55~+150	°C

1. FR-5 = 1.0×0.75×0.062 in.

5. ELECTRICAL CHARACTERISTICS (Ta= 25°C)

Characteristic	Symbol	Min.	Typ.	Max.	Unit
Collector–Emitter Breakdown Voltage (IC = 1 mAdc, IB = 0)	VBR(CEO)	32	-	-	V
Collector–Base Breakdown Voltage (IC = 100 µAdc, IE = 0)	VBR(CBO)	40	-	-	V
Emitter–Base Breakdown Voltage (IE = 100 µAdc, IC = 0)	VBR(EBO)	5	-	-	V
Collector Cutoff Current (VCB = 20 Vdc, IE = 0)	ICBO	-	-	1	µA
Emitter Cutoff Current (VEB = 4.0 Vdc, IC = 0)	IEBO	-	-	1	µA
DC Current Gain (IC = 100 mAdc, VCE = 3.0 Vdc)	HFE	180	-	390	
Collector–Emitter Saturation Voltage (IC = 500 mAdc, IB = 50 mAdc)	VCE(sat)	-	-	0.4	V
Base–Emitter Saturation Voltage (IC = 500 mAdc, IB = 50 mAdc)	VBE(sat)	-	-	1.2	V
Current–Gain — Bandwidth Product (IE = -20mAdc, VCE=5Vdc, f = 100MHz)	fT	-	250	-	MHz
Output Capacitance (VCB = 10 Vdc, IE = 0, f = 1.0 MHz)	Cob	-	6	-	pF

6. ELECTRICAL CHARACTERISTICS CURVES

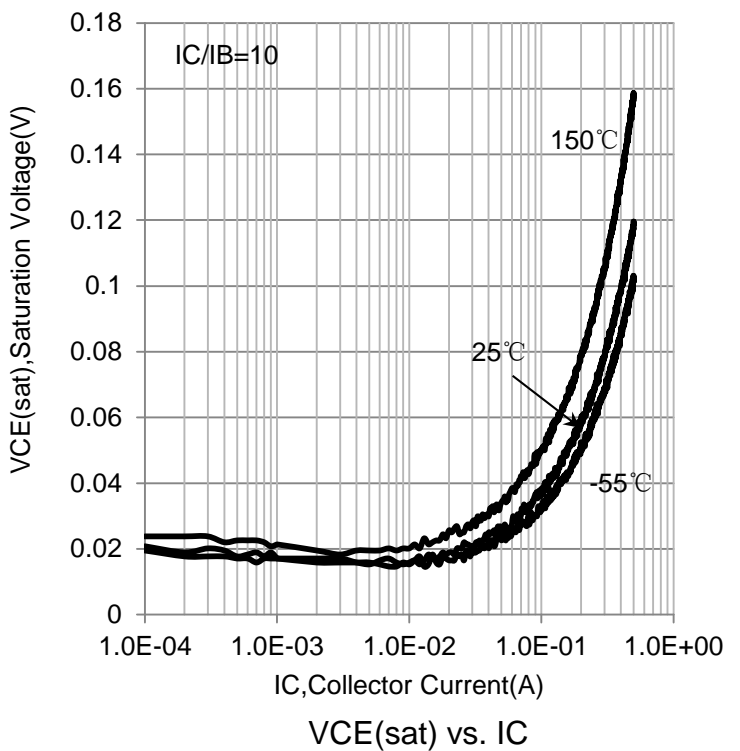
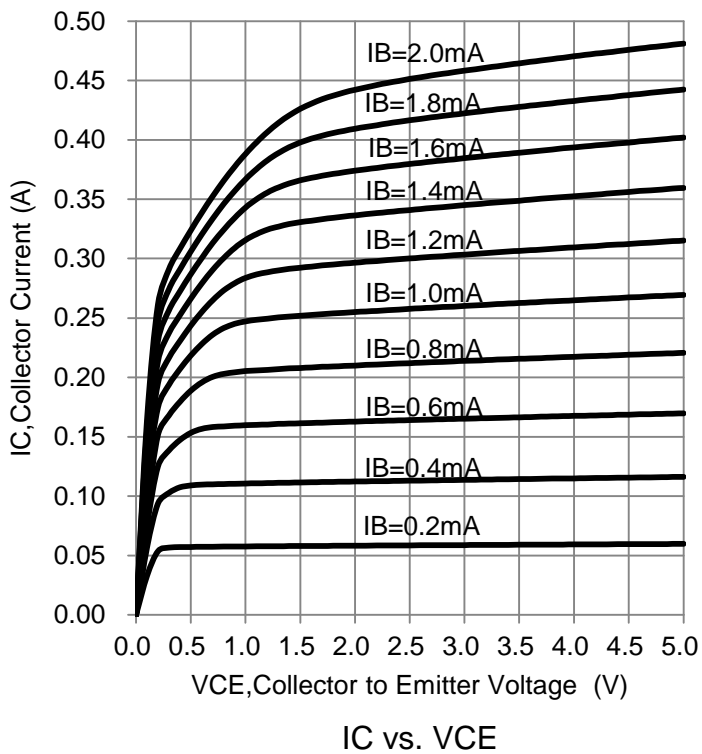
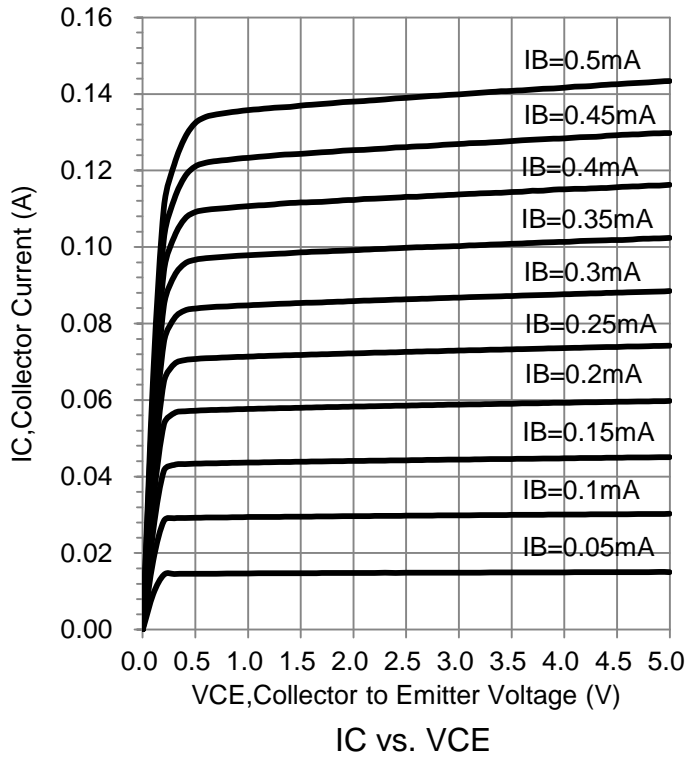
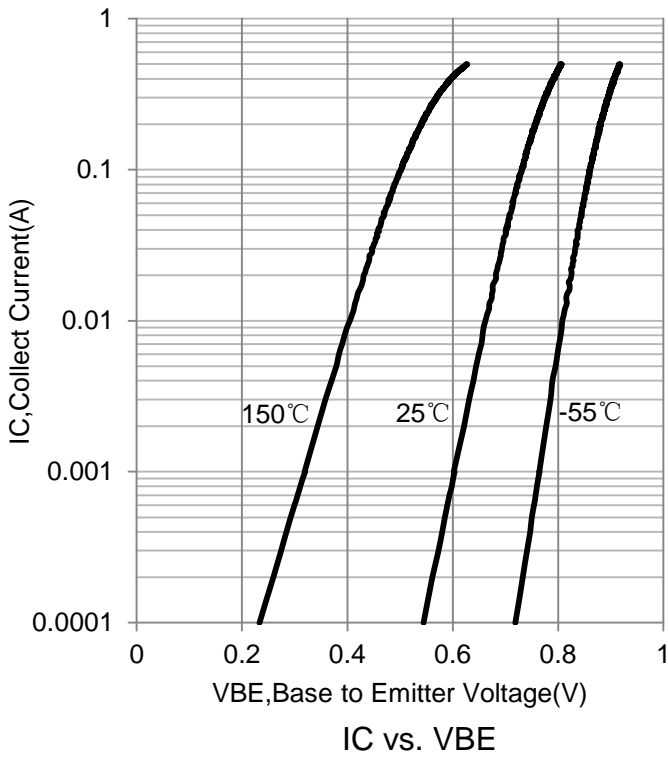

6. ELECTRICAL CHARACTERISTICS CURVES(Con.)

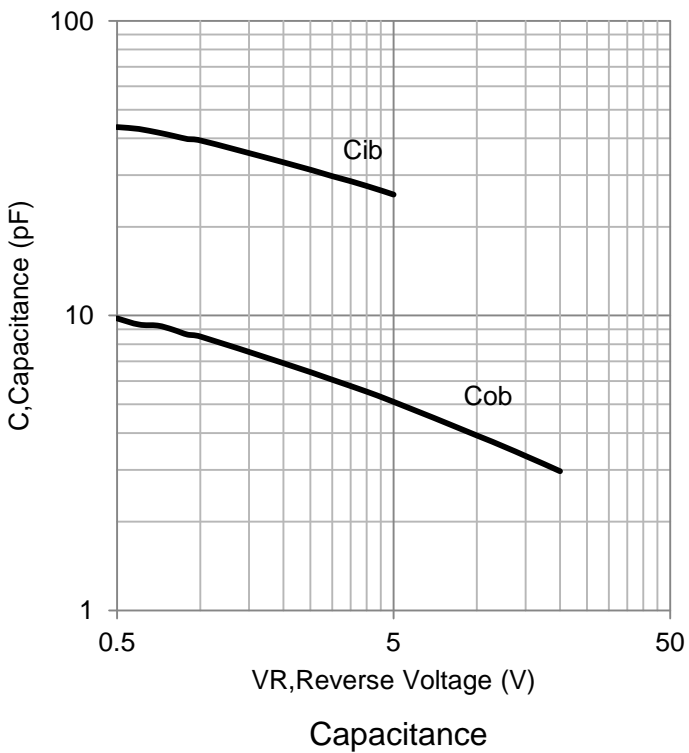
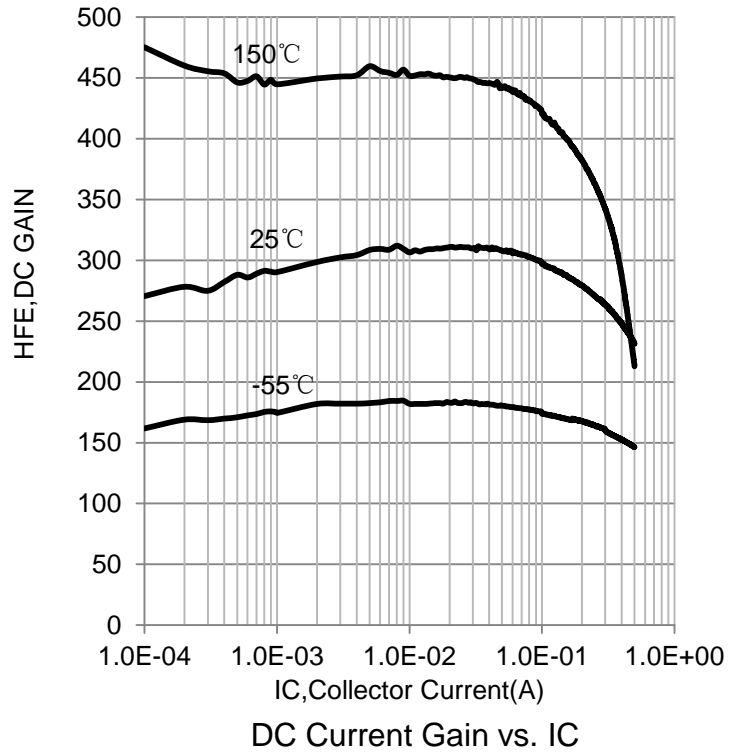
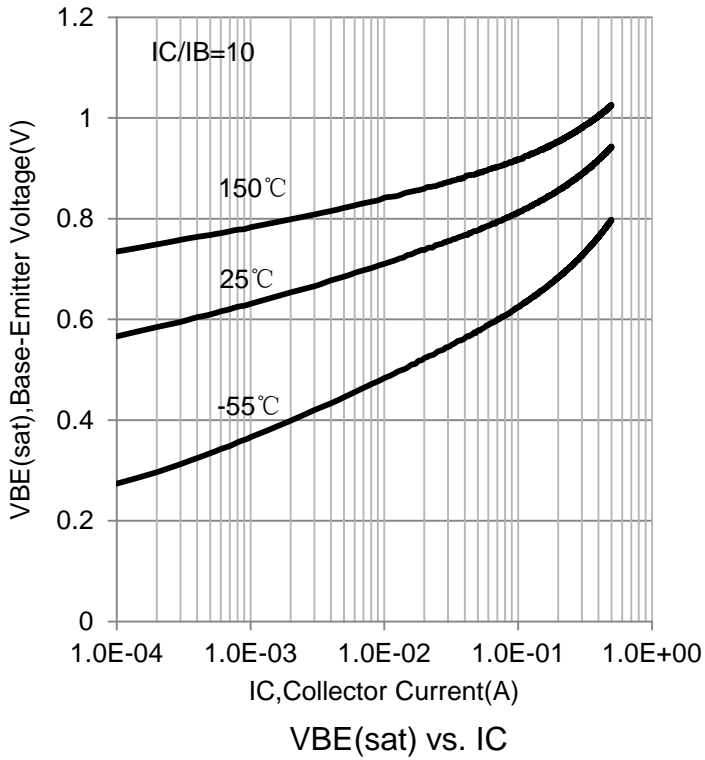

7. OUTLINE AND DIMENSIONS

SOT-23

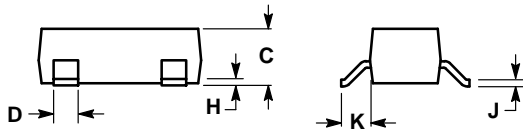
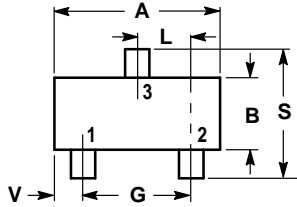

NOTES:

1. DIMENSIONING AND TOLERANCING PER ANSI Y14.5M, 1982.
2. CONTROLLING DIMENSION: INCH.

DIM	INCHES		MILLIMETERS	
	MIN	MAX	MIN	MAX
A	0.1102	0.1197	2.80	3.04
B	0.0472	0.0551	1.20	1.40
C	0.0350	0.0440	0.89	1.11
D	0.0150	0.0200	0.37	0.50
G	0.0701	0.0807	1.78	2.04
H	0.0005	0.0040	0.013	0.100
J	0.0034	0.0070	0.085	0.177
K	0.0140	0.0285	0.35	0.69
L	0.0350	0.0401	0.89	1.02
S	0.0830	0.1039	2.10	2.64
V	0.0177	0.0236	0.45	0.60

- PIN 1. BASE
 2. EMITTER
 3. COLLECTOR

8. SOLDERING FOOTPRINT

