

Power MOSFET

20 V, 3.2 A, Single N-Channel, SOT-23

Features

- Leading Planar Technology for Low Gate Charge / Fast Switching
- 2.5 V Rated for Low Voltage Gate Drive
- SOT-23 Surface Mount for Small Footprint
- Pb-Free Package is Available
- S- Prefix for Automotive and Other Applications Requiring Unique Site and Control Change Requirements; AEC-Q101 Qualified and PPAP Capable.

Applications

- Load/Power Switch for Portables
- Load/Power Switch for Computing
- DC-DC Conversion

$V_{(BR)DSS}$	$R_{DS(on)}$ TYP	I_D MAX (Note 1)
20 V	70 m Ω @ 4.5 V	3.6 A
	85 m Ω @ 2.5 V	3.1 A

MAXIMUM RATINGS ($T_J = 25^\circ\text{C}$ unless otherwise stated)

Parameter		Symbol	Value	Unit	
Drain-to-Source Voltage		V_{DSS}	20	V	
Gate-to-Source Voltage		V_{GS}	± 12	V	
Continuous Drain Current (Note 1)	Steady State	I_D	$T_A = 25^\circ\text{C}$	3.2	A
			$T_A = 85^\circ\text{C}$	2.4	A
Steady State Power Dissipation (Note 1)	Steady State	P_D	1.25	W	
Pulsed Drain Current	$t_p = 10 \mu\text{s}$	I_{DM}	10.0	A	
Operating Junction and Storage Temperature		T_J, T_{stg}	-55 to 150	$^\circ\text{C}$	
Continuous Source Current (Body Diode)		I_S	1.6	A	
Lead Temperature for Soldering Purposes (1/8" from case for 10 s)		T_L	260	$^\circ\text{C}$	

Maximum ratings are those values beyond which device damage can occur. Maximum ratings applied to the device are individual stress limit values (not normal operating conditions) and are not valid simultaneously. If these limits are exceeded, device functional operation is not implied, damage may occur and reliability may be affected.

THERMAL RESISTANCE RATINGS

Parameter	Symbol	Max	Unit
Junction-to-Ambient (Note 1)	$R_{\theta JA}$	100	$^\circ\text{C}/\text{W}$
Junction-to-Ambient (Note 2)	$R_{\theta JA}$	300	

1. Surface-mounted on FR4 board using 1 in sq pad size (Cu area = 1.127 in sq [1 oz] including traces).
2. Surface-mounted on FR4 board using the minimum recommended pad size.

LN4501LT1G
S-LN4501LT1G

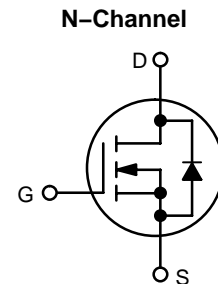
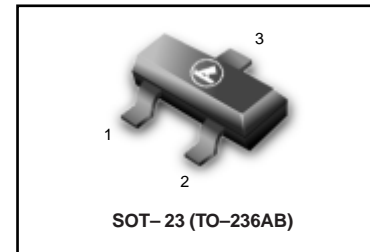

ORDERING INFORMATION

Device	Package	Shipping†
LN4501LT1G S-LN4501LT1G	N45	3000 / Tape & Reel
LN4501LT3G S-LN4501LT3G	N45	10000 / Tape & Reel

LN4501LT1G , S-LN4501LT1G

Electrical Characteristics (T_J = 25°C unless otherwise specified)

Parameter	Symbol	Test Condition	Min	Typ	Max	Units
-----------	--------	----------------	-----	-----	-----	-------

OFF CHARACTERISTICS

Drain-to-Source Breakdown Voltage (Note 3)	V _{(BR)DSS}	V _{GS} = 0 V, I _D = 250 μA	20	24.5		V
Drain-to-Source Breakdown Voltage Temperature Coefficient	V _{(BR)DSS} /T _J			22		mV/°C
Zero Gate Voltage Drain Current	I _{DSS}	V _{GS} = 0 V, T _J = 25°C			1.5	μA
		V _{DS} = 16 V, T _J = 85°C			10	μA
Gate-to-Source Leakage Current	I _{GSS}	V _{DS} = 0 V, V _{GS} = ±12 V			±100	nA

ON CHARACTERISTICS

Gate Threshold Voltage (Note 3)	V _{GS(TH)}	V _{GS} = V _{DS} , I _D = 250 μA	0.60		1.2	V
Negative Threshold Temperature Coefficient	V _{GS(TH)} /T _J			-2.3		mV/°C
Drain-to-Source On Resistance	R _{DS(on)}	V _{GS} = 4.5 V, I _D = 3.6 A		70	80	mΩ
		V _{GS} = 2.5 V, I _D = 3.1 A		85	105	
Forward Transconductance	g _{FS}	V _{DS} = 5.0 V, I _D = 3.6 A		9		S

CHARGES AND CAPACITANCES

Input Capacitance	C _{iSS}	V _{GS} = 0 V, f = 1.0 MHz, V _{DS} = 10 V		200		pF
Output Capacitance	C _{oSS}			80		
Reverse Transfer Capacitance	C _{rSS}			50		
Total Gate Charge	Q _{G(TOT)}	V _{GS} = 4.5 V, V _{DS} = 10 V, I _D = 3.6 A		2.4	6.0	nC
Gate-to-Source Gate Charge	Q _{GS}			0.5		
Gate-to-Drain Charge	Q _{GD}			0.6		

SWITCHING CHARACTERISTICS (Note 4)

Turn-On Delay Time	t _{d(on)}	V _{GS} = 4.5 V, V _{DS} = 10 V, I _D = 3.6 A, R _G = 6.0 Ω		6.5		ns
Rise Time	t _r			12		
Turn-Off Delay Time	t _{d(off)}			12		
Fall Time	t _f			3		

SOURCE-DRAIN DIODE CHARACTERISTICS

Forward Diode Voltage	V _{SD}	V _{GS} = 0 V, I _{SD} = 1.6 A		0.8	1.2	V
Reverse Recovery Time	t _{RR}	V _{GS} = 0 V, dI _S /dt = 100 A/μs, I _S = 1.6 A		7.1		ns
Charge Time	t _a			5		
Discharge Time	t _b			1.9		
Reverse Recovery Charge	Q _{RR}			3.0		nC

3. Pulse Test: Pulse width ≤ 300 μs, duty cycle ≤ 2%.

4. Switching characteristics are independent of operating junction temperatures.

LN4501LT1G , S-LN4501LT1G

TYPICAL ELECTRICAL CHARACTERISTICS

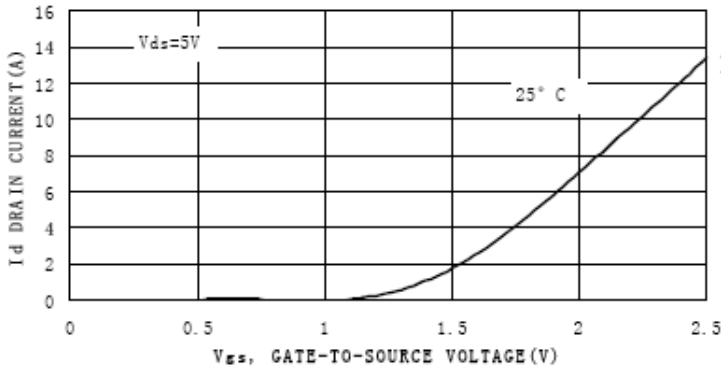

Figure 1. Transfer Characteristics

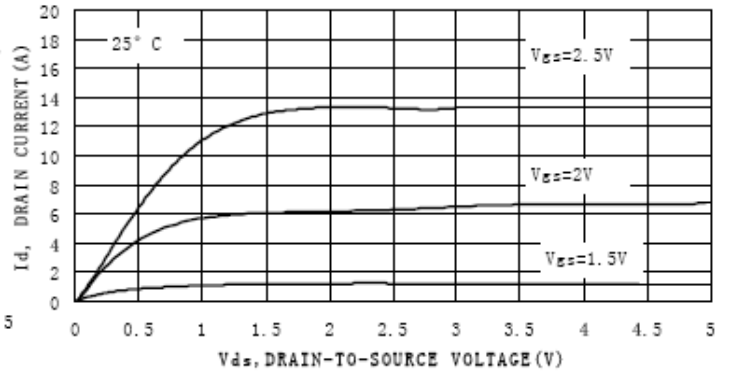

Figure 2. On-Region Characteristics

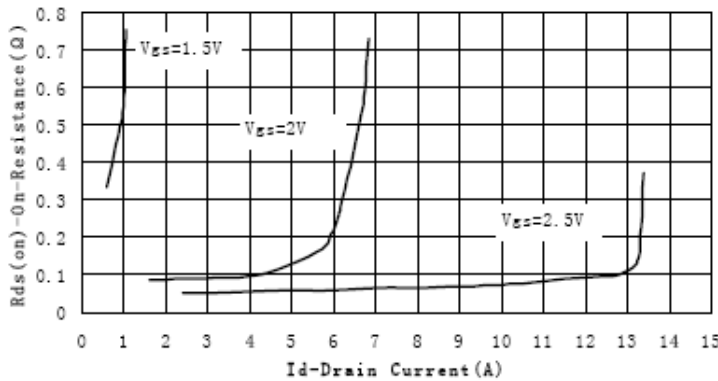

Figure 3. On-Resistance versus Drain Current

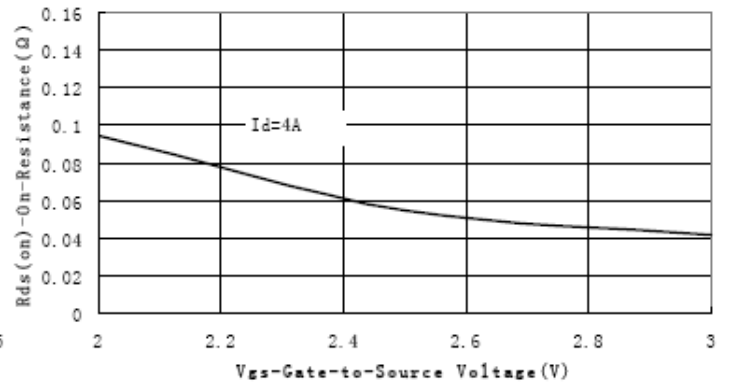
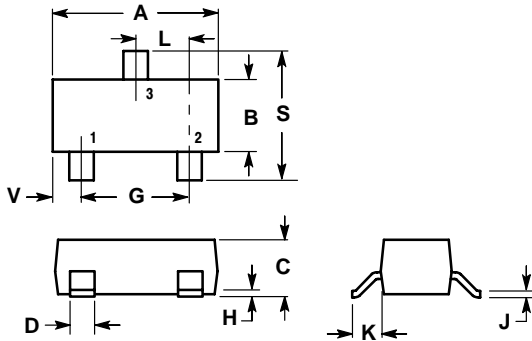

Figure 4. On-Resistance vs. Gate-to-Source Voltage

LN4501LT1G , S-LN4501LT1G

SOT-23



NOTES:

1. DIMENSIONING AND TOLERANCING PER ANSI Y14.5M, 1982.
2. CONTROLLING DIMENSION: INCH.
3. MAXIMUM LEAD THICKNESS INCLUDES LEAD FINISH THICKNESS. MINIMUM LEAD THICKNESS IS THE MINIMUM THICKNESS OF BASE MATERIAL.
4. 318-01 THRU -07 AND -09 OBSOLETE, NEW STANDARD 318-08.

DIM	INCHES		MILLIMETERS	
	MIN	MAX	MIN	MAX
A	0.1102	0.1197	2.80	3.04
B	0.0472	0.0551	1.20	1.40
C	0.0350	0.0440	0.89	1.11
D	0.0150	0.0200	0.37	0.50
G	0.0701	0.0807	1.78	2.04
H	0.0005	0.0040	0.013	0.100
J	0.0034	0.0070	0.085	0.177
K	0.0140	0.0285	0.35	0.69
L	0.0350	0.0401	0.89	1.02
S	0.0830	0.1039	2.10	2.64
V	0.0177	0.0236	0.45	0.60

STYLE 21:

- PIN 1. GATE
2. SOURCE
3. DRAIN

SOLDERING FOOTPRINT*

