

P-Channel 1.8-V (G-S) MOSFET

LSI1013XT1G
S-LSI1013XT1G

FEATURES

- TrenchFET® Power MOSFET: 1.8-V Rated
- Gate-Source ESD Protected: 2000 V
- High-Side Switching
- Low On-Resistance: 1.2 Ω
- Low Threshold: 0.8 V (typ)
- Fast Switching Speed: 14 ns
- S- Prefix for Automotive and Other Applications Requiring Unique Site and Control Change Requirements; AEC-Q101 Qualified and PPAP Capable.

BENEFITS

- Ease in Driving Switches
- Low Offset (Error) Voltage
- Low-Voltage Operation
- High-Speed Circuits
- Low Battery Voltage Operation

APPLICATIONS

- Drivers: Relays, Solenoids, Lamps, Hammers, Displays, Memories
- Battery Operated Systems
- Power Supply Converter Circuits
- Load/Power Switching Cell Phones, Pagers

ORDERING INFORMATION

Device	Marking	Shipping
LSI1013XT1G S-LSI1013XT1G	B	3000/Tape&Reel
LSI1013XT3G S-LSI1013XT3G	B	10000/Tape&Reel

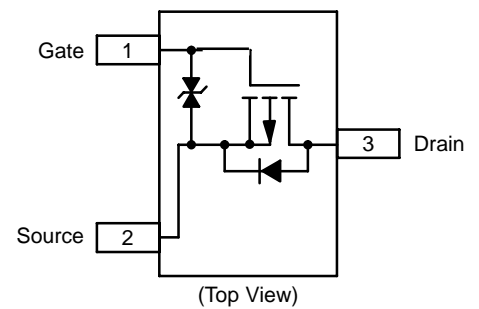
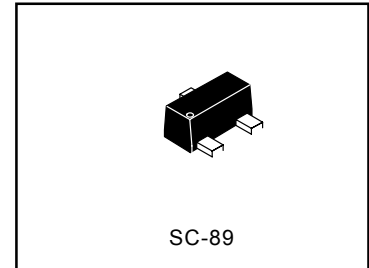

MARKING DIAGRAM

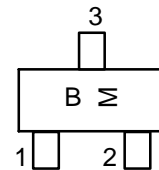

B = Specific Device Code
M = Month Code

ABSOLUTE MAXIMUM RATINGS (T _A = 25°C UNLESS OTHERWISE NOTED)					
Parameter	Symbol	5 secs	Steady State	Unit	
Drain-Source Voltage	V _{DS}		-20	V	
Gate-Source Voltage	V _{GS}		±6		
Continuous Drain Current (T _J = 150°C) ^b	I _D	T _A = 25°C	-400	-350	mA
		T _A = 85°C	-300	-275	
Pulsed Drain Current ^a	I _{DM}		-1000		
Continuous Source Current (diode conduction) ^b	I _S	-275	-250		
Maximum Power Dissipation ^b for SC-75	P _D	T _A = 25°C	175	150	mW
		T _A = 85°C	90	80	
Maximum Power Dissipation ^b for SC-89	P _D	T _A = 25°C	275	250	
		T _A = 85°C	160	140	
Operating Junction and Storage Temperature Range	T _J , T _{stg}	-55 to 150		°C	
Gate-Source ESD Rating (HBM, Method 3015)	ESD	2000		V	

Notes

- d. Pulse width limited by maximum junction temperature.
- e. Surface Mounted on FR4 Board.

LSI1013XT1G , S-LSI1013XT1G

SPECIFICATIONS (T _A = 25 °C UNLESS OTHERWISE NOTED)						
Parameter	Symbol	Test Condition	Min	Typ	Max	Unit
Static						
Gate Threshold Voltage	V _{GS(th)}	V _{DS} = V _{GS} , I _D = -250 μA	-0.45			V
Gate-Body Leakage	I _{GSS}	V _{DS} = 0 V, V _{GS} = ±4.5 V		±1	±2	μA
Zero Gate Voltage Drain Current	I _{DSS}	V _{DS} = -16 V, V _{GS} = 0 V		-0.3	-100	nA
		V _{DS} = -16 V, V _{GS} = 0 V, T _J = 85 °C			-5	μA
On-State Drain Current ^a	I _{D(on)}	V _{DS} = -5 V, V _{GS} = -4.5 V	-700			mA
Drain-Source On-State Resistance ^a	r _{DS(on)}	V _{GS} = -4.5 V, I _D = -350 mA		0.8	1.2	Ω
		V _{GS} = -2.5 V, I _D = -300 mA		1.2	1.6	
		V _{GS} = -1.8 V, I _D = -10 mA		1.8	2.7	
Forward Transconductance ^a	g _{fs}	V _{DS} = -10 V, I _D = -250 mA		0.4		S
Diode Forward Voltage ^a	V _{SD}	I _S = -150 mA, V _{GS} = 0 V		-0.8	-1.2	V
Dynamic^b						
Total Gate Charge	Q _g	V _{DS} = -10 V, V _{GS} = -4.5 V, I _D = -250 mA		1500		pC
Gate-Source Charge	Q _{gs}			150		
Gate-Drain Charge	Q _{gd}			450		
Turn-On Delay Time	t _{d(on)}	V _{DD} = -10 V, R _L = 47 Ω I _D ≅ -200 mA, V _{GEN} = -4.5 V, R _G = 10 Ω		5		ns
Rise Time	t _r			9		
Turn-Off Delay Time	t _{d(off)}			35		
Fall Time	t _f			11		

Notes

- a. Pulse test; pulse width ≤ 300 μs, duty cycle ≤ 2%.
- b. Guaranteed by design, not subject to production testing.

LSI1013XT1G , S-LSI1013XT1G

TYPICAL CHARACTERISTICS (T_A = 25°C UNLESS NOTED)

For the following graphs, p-channel negative polarities for all voltage and current values are represented as positive values.

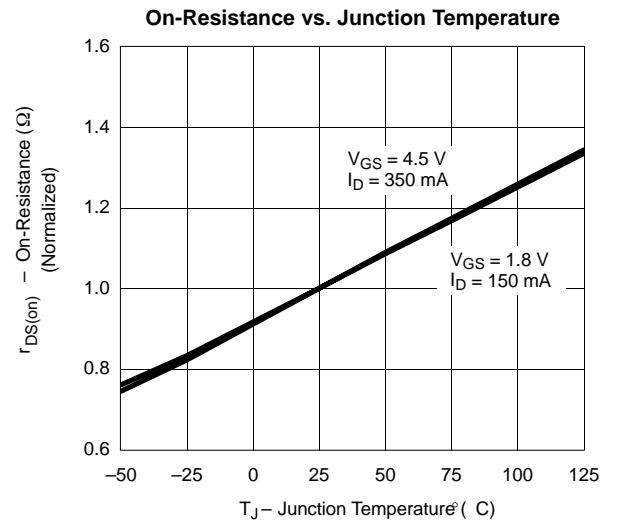
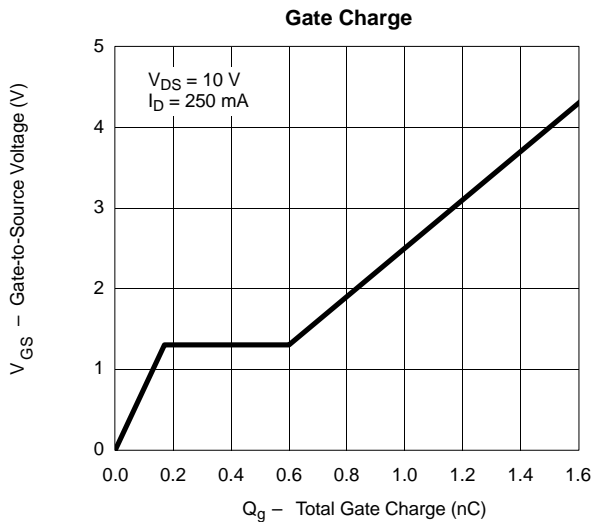
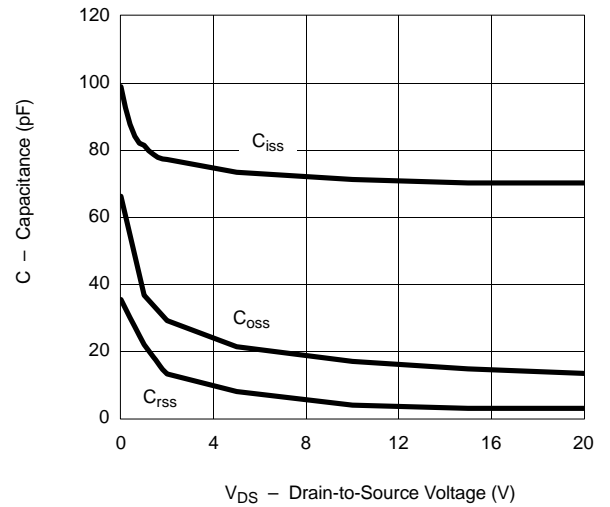
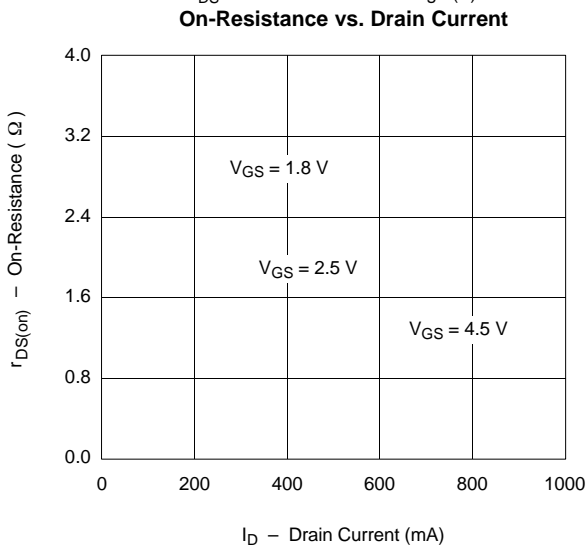
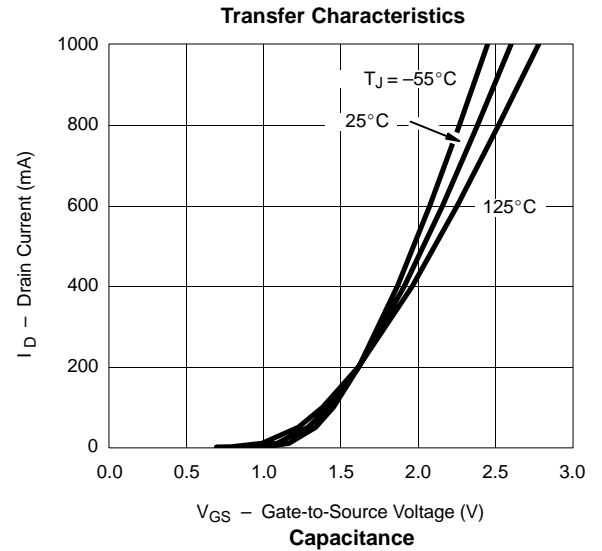
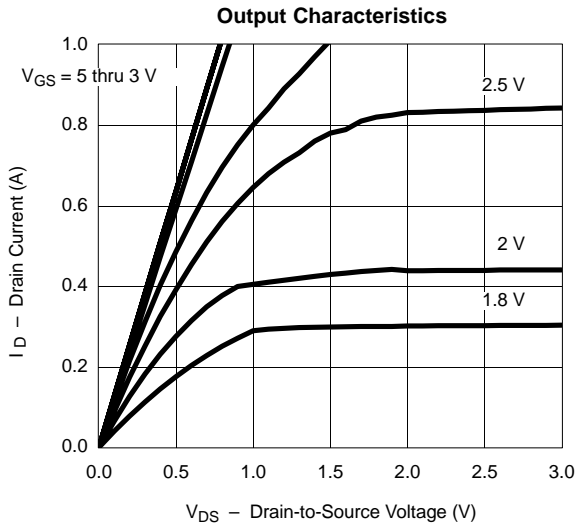

LSI1013XT1G , S-LSI1013XT1G

TYPICAL CHARACTERISTICS (T_A = 25 °C UNLESS NOTED)

Source-Drain Diode Forward Voltage

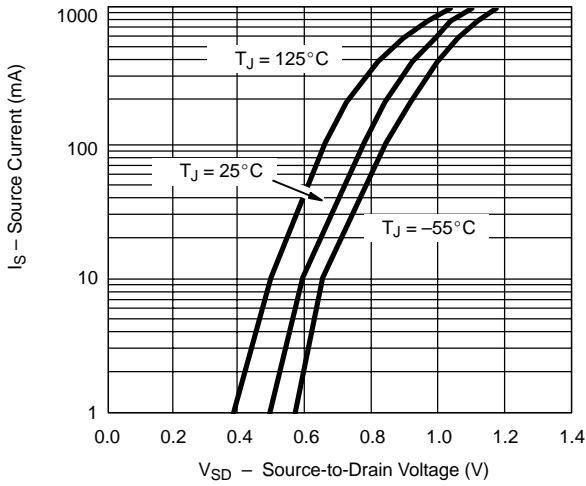

On-Resistance vs. Gate-to-Source Voltage

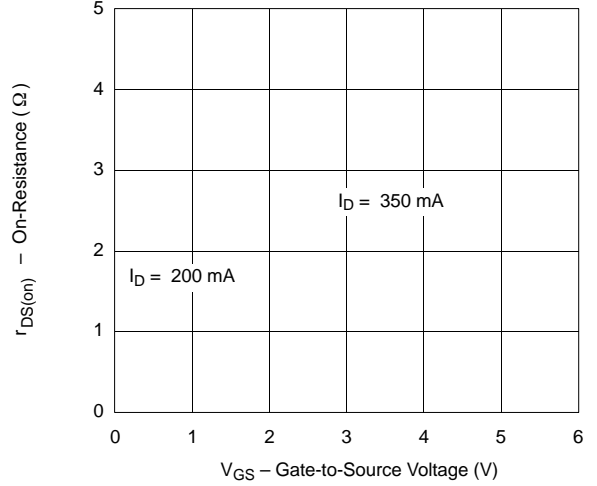

Threshold Voltage Variance vs. Temperature

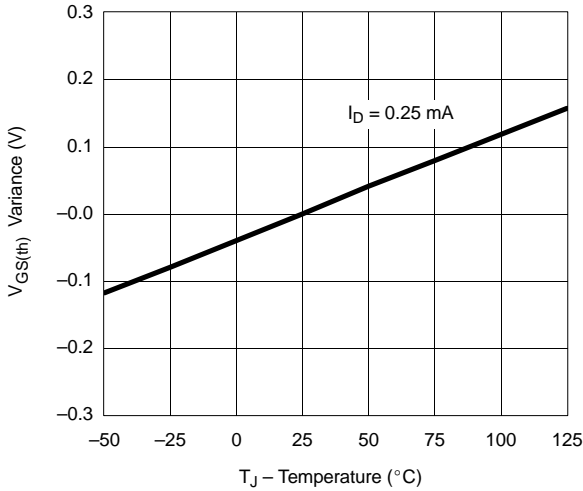

I_{GSS} vs. Temperature

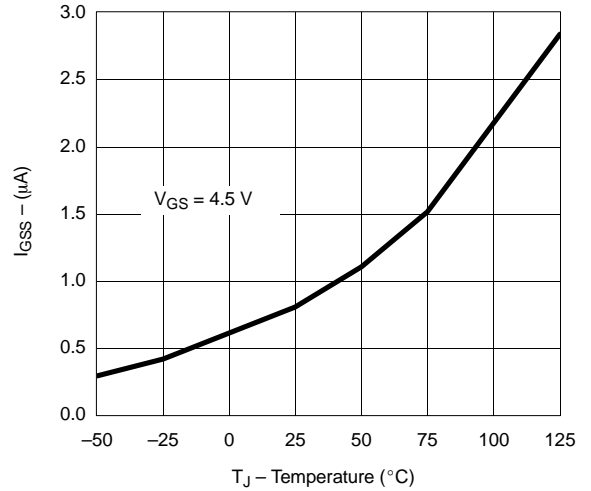

BV_{GSS} vs. Temperature

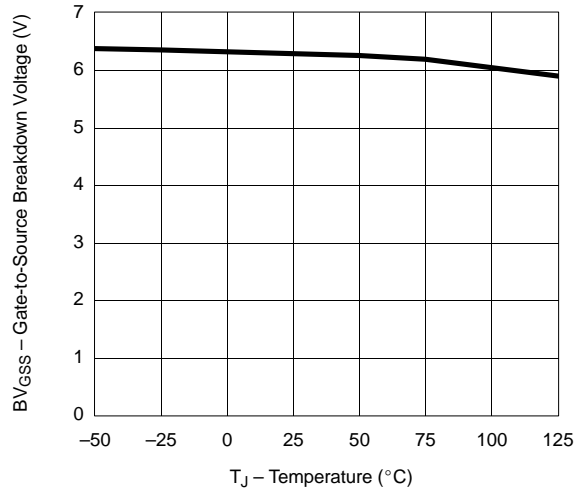

LSI1013XT1G , S-LSI1013XT1G

TYPICAL CHARACTERISTICS ($T_A = 25^\circ\text{C}$ UNLESS NOTED)

Normalized Thermal Transient Impedance, Junction-to-Ambient (SC-75A)

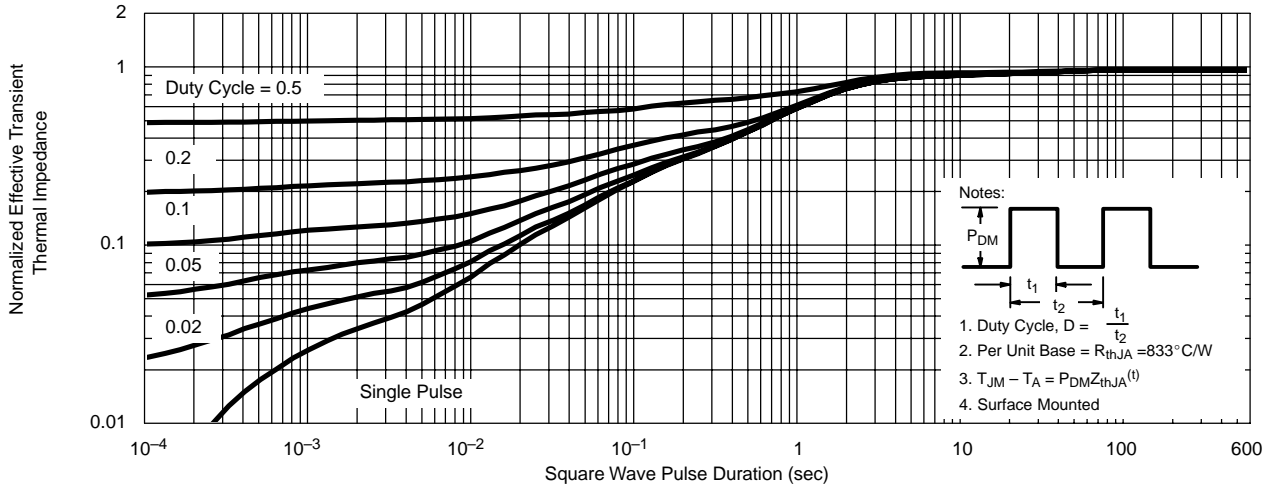

Normalized Thermal Transient Impedance, Junction-to-Foot

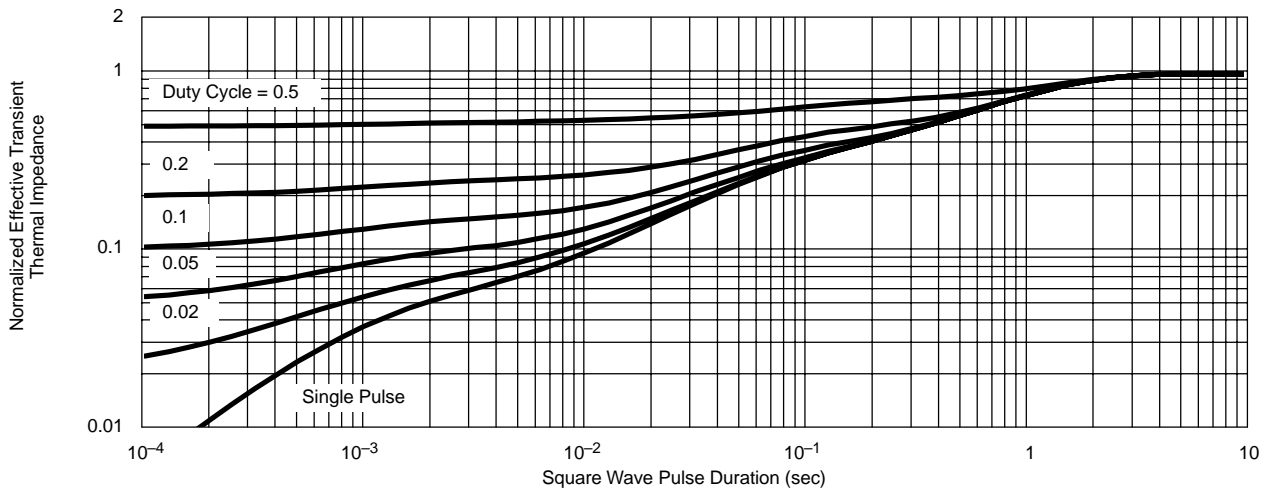

LSI1013XT1G , S-LSI1013XT1G

SC-89

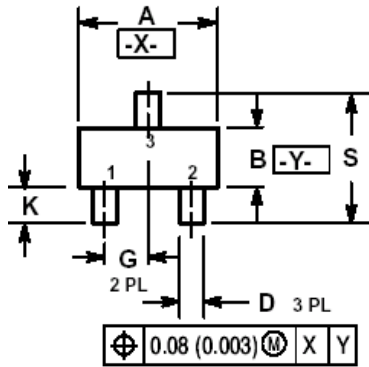

NOTES:

- 1.DIMENSIONING AND TOLERANCING PER ANSI Y14.5M, 1982.
- 2.CONTROLLING DIMENSION: MILLIMETERS
- 3.MAXIMUM LEAD THICKNESS INCLUDES LEAD FINISH THICKNESS. MINIMUM LEAD THICKNESS IS THE MINIMUM THICKNESS OF BASE MATERIAL.
- 4.463C-01 OBSOLETE, NEW STANDARD 463C-02.

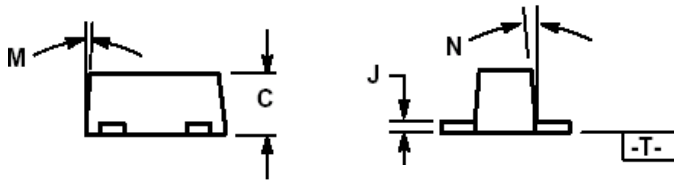

DIM	MILLIMETERS			INCHES		
	MIN	NOM	MAX	MIN	NOM	MAX
A	1.50	1.60	1.70	0.059	0.063	0.067
B	0.75	0.85	0.95	0.030	0.034	0.040
C	0.60	0.70	0.80	0.024	0.028	0.031
D	0.23	0.28	0.33	0.009	0.011	0.013
G	0.50 BSC			0.020 BSC		
H	0.53 REF			0.021 REF		
J	0.10	0.15	0.20	0.004	0.006	0.008
K	0.30	0.40	0.50	0.012	0.016	0.020
L	1.10 REF			0.043 REF		
M	---	---	10 °	---	---	10 °
N	---	---	10 °	---	---	10 °
S	1.50	1.60	1.70	0.059	0.063	0.067

