

承认书

APPROVAL SHEET

厂商：丽智电子（昆山）有限公司

客户： _____

：丽智电子（南通）有限公司

Supplier:

customer:

核准 Approved by	审核 Checked by	制作 Prepared by

地址：江苏省昆山市汉浦路 989 号

Address: No. 989, Hanpu Road Kunshan City Jiangsu Province

Tel:0086-0512-57780531

Fax:0086-0512-57789581

地址：江苏省南通市通州区康富路 789 号

Address: No. 789, Kang Fu Road Tongzhou District Nantong city Jiangsu province

Tel: 0086-0513-68856666

Fax: 0086-0513-68383688

厚膜贴片电阻承认书-CR 系列

Approval Specification for Thick Film Chip Resistors - Type **CR**

1. 范围 (scope) :

1.1 适用于本公司所生产的无铅、无卤之厚膜贴片电阻 CR 系列

This specification applies to thick film chip resistors which meet requirements of Pb free and halogen free.

1.2 本公司的无铅产品指的贴片电阻端电极无铅，而存在于电阻层的玻璃中的符合 RoHS 豁免条款。

There no lead exists in terminal of resistor, and lead which exist in glass of resistor layer meets RoHS exemption.

2. 产品料号 (part number) :

0603 1/10W 5% 100 Ω





CR0603JA0101G

<u>CR</u>	<u>0603</u>	<u>J</u>	<u>A</u>	<u>0101</u>	<u>G</u>
↓	↓	↓	↓	↓	↓
类型(Type) CR: 厚膜贴片 电阻(thick film chip resistors)	尺寸(Size) 0201 0402 0603 0805 1206 1210 1812 2010 2512	公差 Tolerance B=±0.1% D=±0.5% F=±1% G=±2% J=±5% K=±10%	额定功率 Rated Power 1= 1W 2= 1/2W 2= 3/4W (for 2010) 3=1/3W 3= 1/2W (for 1210) 4= 1/4W 8= 1/8W A= 1/10W F= 1/16W H=1/20W	阻值 Resistance value ±1% , ±0.5% : 49R9=49.9 Ω 1002=10K Ω ±2% , ±5% : 06R8=6.8 Ω 0564=560K Ω	包装代码 Packing Code G= reel (卷装) V= bulk (散料) S= Double Standard Quantity (两倍卷 盘标准包装量)

厚膜贴片电阻承认书-CR 系列

Approval Specification for Thick Film Chip Resistors - Type **CR**

3. 电阻本体字码标示(Marking on the Resistor's Body):

<p>※ 0201 及 0402 因本体太小，本体上无字码标示 For 0201 and 0402 size, no marking on the body due to the small size of the resistor</p>		<p>472=47×10²=4.7KΩ</p>
<p>※ 公差±5%的产品，以三字码标示，前两位表示阻值的有效数字，最后一位表示 10 的乘幂 ±5% tolerance product: the marking is 3 digits, the first 2 digits are significant figures of resistance value and the 3rd one denotes the power number of 10, (10^x)</p>		<p>10Ω 以下标示: 5R6=5.6Ω Below 10Ω: 5R6=5.6Ω</p>
<p>※ ±0.5%, ±1%的产品，以四字码标示，前三位表示阻值的有效数字，最后一位表示 10 的乘幂 ±0.5%, ±1% tolerance product: the marking is 4 digits, the first 3 digits are significant figures of resistance value and the 4th one denotes the power number of 10, (10^x)</p>		<p>4992=499×10²=49.9KΩ</p>
<p>※ 0603 ±1% E96 系列的标准阻值，因电阻本体太小，采用三位代码标示。 Standard E96 series values of 0603 ±1%: due to the small size of the resistor's body, use 3digits code to indicate the resistance value.</p>		<p>100Ω 以下标示: 6R81=6.81Ω Below 100Ω: 6R81=6.81Ω</p>
<p>※ 0 欧姆产品，采用 000 三位代码标示。 0Ω Products, use 000 3digits code to indicate the resistance value.</p>		<p>000=0Ω</p>

厚膜贴片电阻承认书-CR 系列

Approval Specification for Thick Film Chip Resistors - Type **CR**

0603 ±1% E96 系列的标准阻值代码(Standard E96 Series Resistance Value Code for 0603 ±1% Marking)

代码 Code	阻值 Value	代码 Code	阻值 Value	代码 Code	阻值 Value	代码 Code	阻值 Value	代码 Code	阻值 Value	代码 Code	阻值 Value
01	100	17	147	33	215	49	316	65	464	81	681
02	102	18	150	34	221	50	324	66	475	82	698
03	105	19	154	35	226	51	332	67	487	83	715
04	107	20	158	36	232	52	340	68	499	84	732
05	110	21	162	37	237	53	348	69	511	85	750
06	113	22	165	38	243	54	357	70	523	86	768
07	115	23	169	39	249	55	365	71	536	87	787
08	118	24	174	40	255	56	374	72	549	88	806
09	121	25	178	41	261	57	383	73	562	89	825
10	124	26	182	42	267	58	392	74	576	90	845
11	127	27	187	43	274	59	402	75	590	91	866
12	130	28	191	44	280	60	412	76	604	92	887
13	133	29	196	45	287	61	422	77	619	93	909
14	137	30	200	46	294	62	432	78	634	94	931
15	140	31	205	47	301	63	442	79	649	95	953
16	143	32	210	48	309	64	453	80	665	96	976

0603 ±1% E96 系列的指数代码(Multiplier Code for 0603 ±1% Marking)

代码 Code	Y	X	A	B	C	D	E	F
指数 Multiplier	10^{-2}	10^{-1}	10^0	10^1	10^2	10^3	10^4	10^5

阻值标示如下(So the resistance value are marked as the following examples)



$$10D=124 \times 10^3=124K \Omega$$



$$38Y=243 \times 10^{-2}=2.43 \Omega$$

0603 ±1%的产品，在标准 E24 系列中，但不属于 E96 系列，标示与 5%的字码相同，但是在字码下加一条线
 Standard E24 and not belong to E96 series values of 0603 ±1%, the marking is the same as 5% tolerance but marking as underline



$$\underline{331}=33 \times 10^1=330 \Omega$$



$$\underline{560}=56 \times 10^0=56 \Omega$$

厚膜贴片电阻承认书-CR 系列

Approval Specification for Thick Film Chip Resistors - Type **CR**

4. 尺寸 (dimension) :

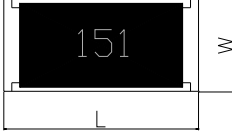
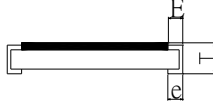
尺寸 dimension					单位 (unit) : mm
	L	W	T	E	
型别 (Type)	L	W	T	E	e
CR0201	0.60±0.03	0.30±0.03	0.23±0.03	0.10±0.05	0.15±0.05
CR0402	1.00±0.05	0.50±0.05	0.30±0.05	0.15±0.10	0.20±0.10
CR0603	1.60±0.10	0.80±0.10	0.45±0.10	0.25±0.20	0.30±0.20
CR0805	2.00±0.15	1.25±0.15	0.50±0.10	0.35±0.20	0.40±0.20
CR1206	3.10±0.15	1.60±0.15	0.55±0.10	0.45±0.25	0.40±0.25
CR1210	3.10±0.15	2.50±0.15	0.55±0.15	0.35±0.25	0.60±0.25
CR1812	4.50±0.20	3.10±0.20	0.55±0.15	0.55±0.20	0.70±0.20
CR2010	5.00±0.20	2.50±0.20	0.55±0.15	0.65±0.25	0.50±0.25
CR2512	6.25±0.20	3.10±0.20	0.55±0.15	0.85±0.25	0.95±0.25

5. 功率衰减曲线 (Derating Curve) :

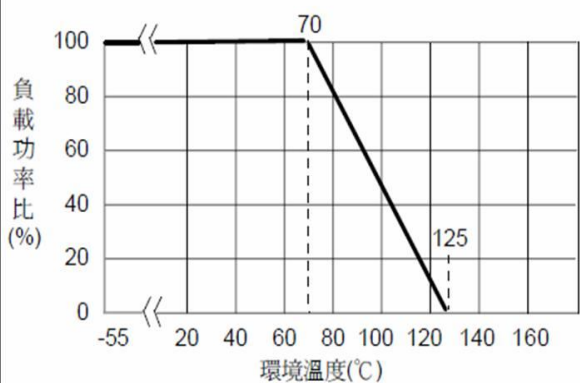
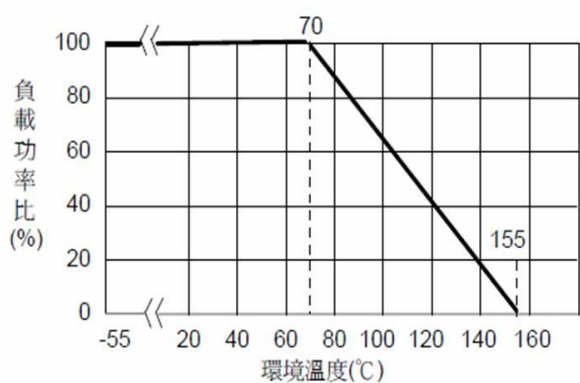
使用 溫度範圍	-55°C ~ +125°C (0201)	-55°C ~ +155°C (其他)
說明	周圍溫度若超過70°C至125°C之間，功率可照下圖曲線予以修定之。	周圍溫度若超過70°C至155°C之間，功率可照下圖曲線予以修定之。
功率 衰減 曲線 圖		

工作溫度範圍 (Operating Temperature Range) : -55°C ~ +155°C;

儲存條件 (storage condition) : 5~30°C, 30~75%RH.

厚膜贴片电阻承认书-CR 系列

Approval Specification for Thick Film Chip Resistors - Type **CR**

6.电阻结构（Construction）：

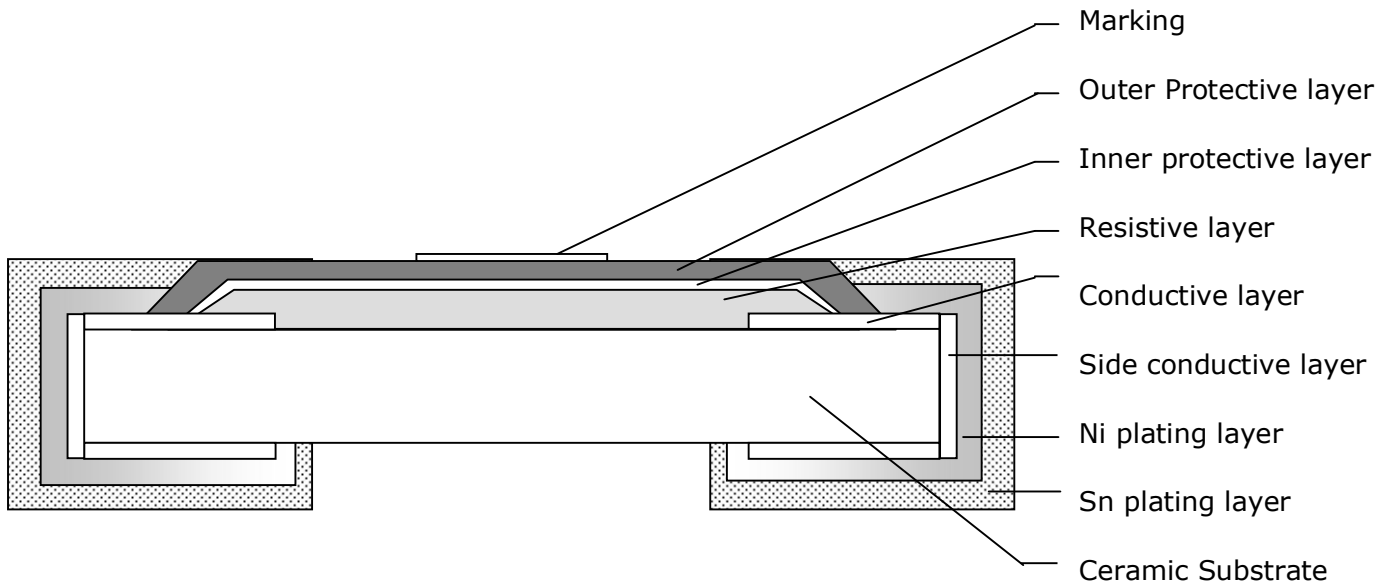

No.	结构 construction	主要材料 Major material
1	陶瓷基板 Ceramic substrate	三氧化二铝 Al ₂ O ₃
2	银电极 Conductive layer	银 Ag
3	侧电极 Side conductive layer	镍铬合金 NiCr
4	阻体层 Resistive layer	氧化钌+玻璃 RuO ₂ + glass
5	内保护层 Inner protective layer	玻璃 Glass
6	外保护层 Outer Protective layer	环氧树脂 Epoxy
7	文字 Marking	环氧树脂 Epoxy
8	镍电极 Ni plating layer	镍 Ni
9	锡电极 Sn plating layer	雾锡 Matte Tin

厚膜贴片电阻承认书-CR 系列

Approval Specification for Thick Film Chip Resistors - Type **CR**

7. 阻值范围 (resistance range) :

型别 Type	阻值范围 Resistance Range			
	0.5%	1%	2%	5%
CR0201	-	1Ω~10MΩ	1Ω~10MΩ	1Ω~10MΩ
CR0402	10Ω~1MΩ	1Ω~22MΩ	1Ω~22MΩ	1Ω~22MΩ
CR0603	10Ω~1MΩ	1Ω~22MΩ	1Ω~22MΩ	1Ω~100MΩ
CR0805	10Ω~1MΩ	1Ω~22MΩ	1Ω~22MΩ	1Ω~100MΩ
CR1206	10Ω~1MΩ	1Ω~22MΩ	1Ω~22MΩ	1Ω~100MΩ
CR1210	10Ω~1MΩ	1Ω~22MΩ	1Ω~22MΩ	1Ω~100MΩ
CR1812	10Ω~1MΩ	1Ω~10MΩ	1Ω~10MΩ	1Ω~10MΩ
CR2010	10Ω~1MΩ	1Ω~22MΩ	1Ω~22MΩ	1Ω~100MΩ
CR2512	10Ω~1MΩ	1Ω~22MΩ	1Ω~22MΩ	1Ω~100MΩ

8. 电气特性 (electrical characteristics) :

型别 Type	CR0201	CR0402	CR0603	CR0805	CR1206	CR1210	CR1812	CR2010	CR2512
额定功率 Rated power	1/20W	1/16W	1/10W	1/8W	1/4W	1/2W	1/2W	3/4W	1W
最大工作电压 Max Working Voltage	25V	50V	75V	150V	200V	200V	200V	200V	200V
最大过负荷电压 Max Overload Voltage	50V	100V	150V	300V	400V	500V	500V	500V	500V
绝缘耐压 Dielectric Withstanding Voltage	75V	150V	220V	430V	570V	710V	710V	710V	710V
零欧姆阻值 Resistance Value of Jumper	<50mΩ	<50mΩ	<50mΩ	<50mΩ	<50mΩ	<50mΩ	<50mΩ	<50mΩ	<50mΩ
零欧姆额定电流 Rated Current of Jumper	0.5A	1.0A	1.0A	2.0A	2.0A	2.0A	2.0A	2.0A	2.0A
零欧姆电阻最大电流 Max Current of Jumper	1.0A	2.0A	2.0A	5.0A	10.0A	10.0A	10.0A	10.0A	10.0A

备注 (remark) :

※ 额定电压计算公式 (The rated voltage is calculated by the following formula) :

$$E = \sqrt{RP}$$

E : 额定电压 (Rated Voltage) (V)

P : 额定功率 (Rated Power) (W)

R : 电阻阻值 (Resistance) (ohm)

※ 如果计算出的电压超过此型别的最大工作电压, 则此型别的最大工作电压为此电阻的额定电压。

In case the value calculated by the formula exceed the maximum working voltage as above table 8, the maximum working voltage shall be regarded as rated voltage.

厚膜贴片电阻承认书-CR 系列

Approval Specification for Thick Film Chip Resistors - Type **CR**

9. 性能(Performance Specifications)

内容 Item	规格 Specification Limits	测试方法 Test Methods
温度系数 Temperature Coefficient	0201 规格： $1\Omega \leq R \leq 10\Omega$ 产品 (Product) : $-100 \sim +300$ PPM/°C $10\Omega < R \leq 10M\Omega$ 产品 (Product) : ± 200 PPM/°C 0402~2512 规格： $1\Omega \leq R \leq 10\Omega$ 产品 (Product) : $-200 \sim +400$ PPM/°C $10\Omega < R \leq 10M\Omega$ 产品 (Product) : ± 100 PPM/°C $10M\Omega < R \leq 100M\Omega$ 产品 (Product) : ± 200 PPM/°C	JIS C 5201 4.8
焊锡性 Solderability	最少 95%面积上锡(Min 95% coverage)	JIS C 5201 4.17
绝缘电阻 Insulation resistance	>10GΩ	JIS C 5201 4.6
绝缘耐压 Dielectric withstanding voltage	无击穿、飞弧及可见机械性损伤 No evidence of flashover, mechanical damage arcing or insulation breakdown	JIS C 5201 4.7
短时间过负荷 Short-time overload	$\pm 5\% & \pm 2\%$: $\pm(2.0\% + 0.05\Omega)$ Max (最大) $\pm 1\% & \pm 0.5\%$: $\pm(1.0\% + 0.05\Omega)$ Max (最大)	JIS C 5201 4.13
端子弯曲 Terminal bending	$\pm(1.0\% + 0.05\Omega)$ Max (最大)	JIS C 5201 4.33
抗焊锡热 Resist to soldering heat	$\pm(1.0\% + 0.05\Omega)$ Max (最大)	JIS C 5201 4.18
负荷寿命 Load life	$\pm(3.0\% + 0.05\Omega)$ Max (最大)	JIS C 5201 4.25.1
耐湿特性 Humidity	$\pm(2.0\% + 0.05\Omega)$ Max (最大)	JIS C 5201 4.24
温度循环 Temperature Cycling	$\pm(2.0\% + 0.05\Omega)$ Max (最大)	JIS C 5201 4.19
温湿循环 Moisture Resistance	$\pm(2.0\% + 0.05\Omega)$ Max (最大)	MIL-STD-202 METHOD 106

10. 包装规格 (Tapping Specification)
10.1 卷盘尺寸 (reel dimension)

尺寸 Dimensions		A	B	C	F	W
CR0201 CR0402 CR0603 CR0805 CR1206 CR1210	mm	178±2.0	60.0±1.0	13.5±0.5	11.4±0.1	9.00±0.3
	Inch	7.008±0.079	2.362±0.039	0.531±0.020	0.449±0.039	0.354±0.012
CR1812 CR2010 CR2512	mm	178±2.0	60.0±1.0	13.5±0.5	15.4±1.0	13.0±0.3
	Inch	7.008±0.079	2.362±0.039	0.531±0.020	0.606±0.039	0.512±0.012

- ※ 备注 (Remark) :
- (1) 0201/0402 每卷 10,000 pcs
0201/0402 Quantity per Reel 10,000 pcs/Reel
 - (2) 1812/2010/2512 每卷 4,000 pcs
1812/ 2010/2512 Quantity per Reel 4,000 pcs/Reel
 - (3) 0603/0805/1206/1210 每卷 5,000pcs
0603/0805/1206/1210 Quantity per Reel 5,000 pcs/Reel
 - (4) 0402 可依客户要求每卷 20,000pcs
0402 Quantity per Reel 20,000 pcs/Reel as customer requirement

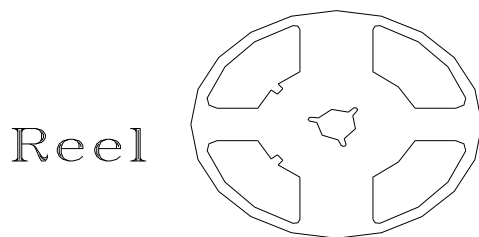

Standard Quantity per Reel
5,000 pcs/Reel

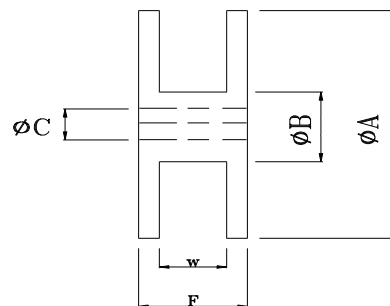

厚膜贴片电阻承认书-CR 系列

Approval Specification for Thick Film Chip Resistors - Type **CR**

10.2 包装尺寸 (packing dimension)

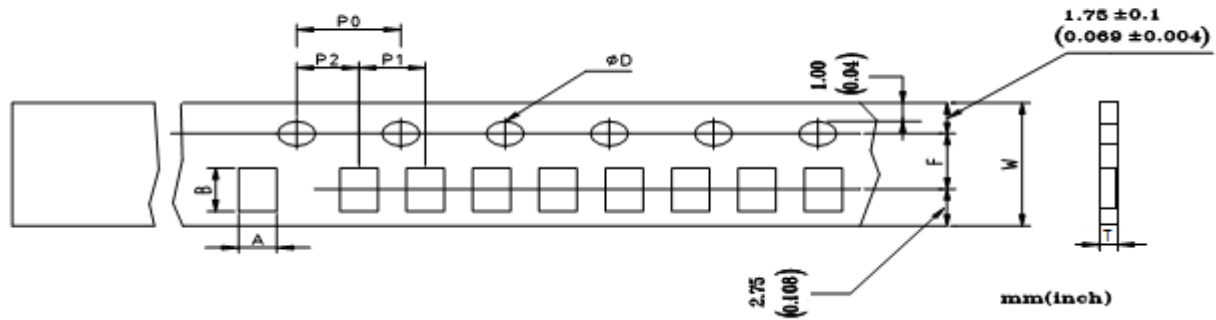

Unit: mm

Dimensions	A	B	D	F	P0	P1	P2	W	T
CR0201	0.38±0.05	0.68±0.05	1.50± _{0.0} ^{0.1}	3.50±0.05	4.00±0.10	2.00±0.10	2.00±0.05	8.00±0.20	0.42±0.07
CR0402	0.65±0.10	1.15±0.10	1.50± _{0.0} ^{0.1}	3.50±0.05	4.00±0.10	2.00±0.10	2.00±0.05	8.00±0.20	0.42±0.07
CR0603	1.10±0.10	1.90±0.10	1.50± _{0.0} ^{0.1}	3.50±0.05	4.00±0.10	4.00±0.10	2.00±0.05	8.00±0.20	0.60±0.07
CR0805	1.65±0.20	2.40±0.20	1.50± _{0.0} ^{0.1}	3.50±0.05	4.00±0.10	4.00±0.10	2.00±0.05	8.00±0.20	0.75±0.07
CR1206	2.00±0.20	3.60±0.20	1.50± _{0.0} ^{0.1}	3.50±0.05	4.00±0.10	4.00±0.10	2.00±0.05	8.00±0.20	0.75±0.07
CR1210	2.80±0.20	3.50±0.20	1.50± _{0.0} ^{0.1}	3.50±0.05	4.00±0.10	4.00±0.10	2.00±0.05	8.00±0.20	0.75±0.07
CR1812	3.30±0.20	4.60±0.20	1.50± _{0.0} ^{0.1}	5.50±0.05	4.00±0.10	4.00±0.10	2.00±0.05	12.0±0.10	1.0±0.07
CR2010	2.90±0.10	5.30±0.10	1.50± _{0.0} ^{0.1}	5.50±0.05	4.00±0.10	4.00±0.10	2.00±0.05	12.0±0.10	1.0±0.07
CR2512	3.40±0.10	6.60±0.10	1.50± _{0.0} ^{0.1}	5.50±0.05	4.00±0.10	4.00±0.10	2.00±0.05	12.0±0.10	1.0±0.07

厚膜贴片电阻承认书-CR 系列

Approval Specification for Thick Film Chip Resistors - Type **CR**

11. 信赖性测试 (Reliability Test Methods)

内容 Item	测试条件 Test Conditions
温度系数 Temperature Coefficient	$TCR = (R - R_0) / (t - t_0) R_0 \times 10^6$ (ppm) R_0 电阻在室温下的阻值(resistance at room temperature) R 电阻在 125°C 或 -55°C 下的阻值(resistance at 125°C or -55°C) t_0 室温(room temperature) t 测试温度 (test temperature 125°C or -55°C)
焊锡性 Solderability	沾助焊剂后浸入锡炉，锡炉温度 245±5°C，时间 2~3 秒 Dip the terminal in a flux and then dip into a soldering bath at 245±5°C for 2~3sec.
绝缘电阻 Insulation resistance	电阻本体上加载最大的工作电压 60±5 秒后，测量绝缘阻抗 Applied the maximum DC working voltage on the center of body for 60 ± 5seconds. Then measure insulation resistance
绝缘耐压 Dielectric withstanding voltage	电阻本体上加载最大的工作电压 60±5 秒。 Applied the maximum DC working voltage on the center of body for 60 ± 5seconds.
短时间过负荷 Short-time overload	加载 2.5 倍的额定电压，时间 5 秒后测量试验前后的阻值变化率。 Applied 2.5 times of rated voltage for 5 second. Measure the variation of resistance. $\Delta R\% = \frac{R_2 - R_1}{R_1} * 100 \text{-----} (\%)$ $R_1 = \text{试验前阻值(resistance before test)}$ $R_2 = \text{试验后阻值(resistance after test)}$
抗焊锡热 Resist to soldering heat	沾助焊剂后浸入锡炉，锡炉温度 260±5°C，时间 10±0.5 秒，测量试验前后的阻值变化率。 Dip the terminal in a flux and then dip into a soldering bath at 260±5°C for 10±0.5sec. Measure the variation of resistance. $\Delta R\% = \frac{R_2 - R_1}{R_1} * 100 \text{-----} (\%)$ $R_1 = \text{试验前阻值(resistance before test)}$ $R_2 = \text{试验后阻值(resistance after test)}$

厚膜贴片电阻承认书-CR 系列

Approval Specification for Thick Film Chip Resistors - Type **CR**

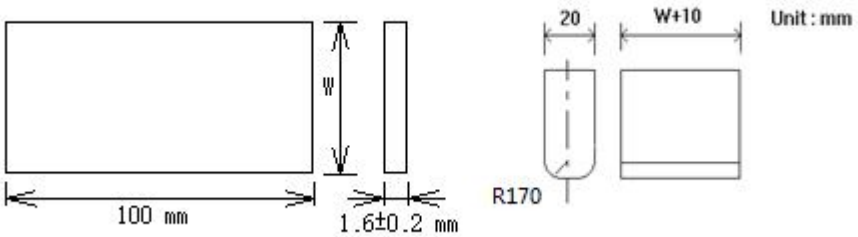
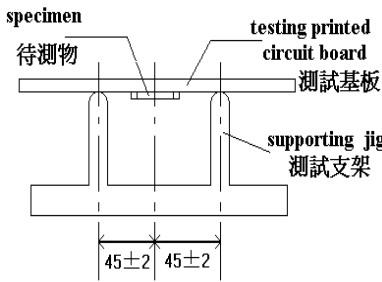
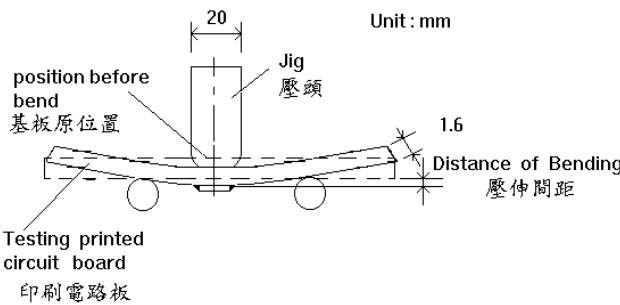
内容 Item	测试条件 Test Conditions
端子弯曲 Terminal bending	<p>电阻焊接在测试板上进行弯折,弯折保持时间 20±1 秒, 1206(含) 以下的尺寸弯曲 $5^{+0.2}/\%$mm; 1206 以上的尺寸弯曲 $2^{+0.2}/\%$mm; 量测试验前后阻值变化率</p> <p>Specimen shall be mounted on test board, then bend the board and maintained for 20±1s. the distance of bending is $5^{+0.2}/\%$mm for resistors which size no larger than 1206 or $2^{+0.2}/\%$mm which size larger than 1206. Measure the variation of resistance.</p> <p style="text-align: center;">测试板 (test board) 压头 (jig)</p> <div style="text-align: center;">  <p style="text-align: right;">Unit: mm</p> </div> <div style="text-align: center;">  </div> <div style="text-align: center;">  <p style="text-align: right;">Unit: mm</p> </div> <div style="text-align: center; margin-top: 20px;"> $\Delta R\% = \frac{R_2 - R_1}{R_1} * 100 \text{-----} (\%)$ <p>R1 = 试验前阻值(resistance before test) R2 = 试验后阻值(resistance after test)</p> </div>

厚膜贴片电阻承认书-CR 系列

Approval Specification for Thick Film Chip Resistors - Type **CR**

内容 Item	测试条件 Test Conditions
负荷寿命 Load life	<p>电阻放入恒温箱中，温度 $70\pm 2^{\circ}\text{C}$，通电额定电压 $1000^{+24}/_{-0}$ 小时，量测试验前后阻值变化率。</p> <p>Put the specimen in a chamber at $70\pm 2^{\circ}\text{C}$ temperature, and applied rated voltage for $1000^{+24}/_{-0}\text{H}$. Measure the variation of resistance.</p> $\Delta R\% = \frac{R_2 - R_1}{R_1} * 100 \text{-----} (\%)$ <p>R1 = 试验前阻值(resistance before test) R2 = 试验后阻值(resistance after test)</p>
耐湿特性 Humidity	<p>电阻放入恒温恒湿箱，温度 $40\pm 2^{\circ}\text{C}$，湿度 90~95 %RH;通电额定电压 1.5 小时，断电 0.5 小时；重复通断电至试验时间 $1000^{+48}/_{-0}$ 小时。量测试验前后阻值变化率。</p> <p>Put the specimen in a chamber at $40\pm 2^{\circ}\text{C}$ temperature and 90~95% relative humidity, then applied rated voltage for 1.5H and rested for 0.5H repeatedly till total test time is $1000^{+48}/_{-0}$. Measure the variation of resistance.</p> $\Delta R\% = \frac{R_2 - R_1}{R_1} * 100 \text{-----} (\%)$ <p>R1 = 试验前阻值(resistance before test) R2 = 试验后阻值(resistance after test)</p>
温度循环 Temperature Cycling	<p>电阻放入温度循环机中，温度 $155\pm 2^{\circ}\text{C}$ 至 $-55\pm 3^{\circ}\text{C}$，共 5 个循环。量测试验前后阻值变化率。</p> <p>Put specimen in a chamber which temperature can be changed to $125\pm 2^{\circ}\text{C}$ or $-55\pm 3^{\circ}\text{C}$, repeated 5 times. Measure the variation of resistance.</p> $\Delta R\% = \frac{R_2 - R_1}{R_1} * 100 \text{-----} (\%)$ <p>R1 = 试验前阻值(resistance before test) R2 = 试验后阻值(resistance after test)</p>

厚膜贴片电阻承认书-CR 系列

Approval Specification for Thick Film Chip Resistors - Type **CR**

内容 Item	测试条件 Test Conditions																																																
温湿循环 Moisture Resistance	<p>电阻放入恒温恒湿箱，加载额定电压，温湿度条件如下表；循环测试 42 次，测试时间 1000 小时。量测试验前后阻值变化率。</p> <p>Put specimen in a chamber and applied rated voltage. Temperature and humidity conditions as following. There are 42 cycles and total test time is 1000H. Measure the variation of resistance.</p> <p style="text-align: center;">表 1 (table1)</p> <table border="1" style="width: 100%; border-collapse: collapse; margin-bottom: 10px;"> <thead> <tr> <th style="width: 15%;">测试条件 test condition</th> <th style="width: 15%;">step1</th> <th style="width: 15%;">step2</th> <th style="width: 15%;">step3</th> <th style="width: 15%;">step4</th> <th style="width: 15%;">step5</th> </tr> </thead> <tbody> <tr> <td>湿度% humidity</td> <td>90~96%</td> <td>90~96%</td> <td>80~96%</td> <td>90~96%</td> <td>90~96%</td> </tr> <tr> <td>温度 temperature</td> <td>升温至 65°C increase to 65°C</td> <td>65°C</td> <td>降温至 25°C decrease to 25°C</td> <td>升温至 65°C increase to 65°C</td> <td>65°C</td> </tr> <tr> <td>时间 time</td> <td>2.5H</td> <td>3H</td> <td>2.5H</td> <td>2.5H</td> <td>3H</td> </tr> </tbody> </table> <table border="1" style="width: 100%; border-collapse: collapse; margin-bottom: 10px;"> <thead> <tr> <th style="width: 15%;">测试条件 test condition</th> <th style="width: 15%;">step6</th> <th style="width: 15%;">step7</th> <th style="width: 15%;">step8</th> <th style="width: 15%;">step9</th> <th style="width: 15%;">step10</th> </tr> </thead> <tbody> <tr> <td>湿度% humidity</td> <td>80~96%</td> <td>90~96%</td> <td>90~96%</td> <td>90~96%</td> <td>90~96%</td> </tr> <tr> <td>温度 temperature</td> <td>降温至 25°C decrease to 25°C</td> <td>25°C</td> <td>降温至 -10°C decrease to -10°C</td> <td>-10°C</td> <td>升温至 25°C increase to 25°C</td> </tr> <tr> <td>时间 time</td> <td>2.5H</td> <td>2H</td> <td>0.5H</td> <td>3H</td> <td>0.5H</td> </tr> </tbody> </table> <p style="text-align: center;"> $\Delta R\% = \frac{R_2 - R_1}{R_1} * 100 \text{-----} (\%)$ </p> <p style="text-align: center;"> R1 = 试验前阻值(resistance before test) R2 = 试验后阻值(resistance after test) </p>	测试条件 test condition	step1	step2	step3	step4	step5	湿度% humidity	90~96%	90~96%	80~96%	90~96%	90~96%	温度 temperature	升温至 65°C increase to 65°C	65°C	降温至 25°C decrease to 25°C	升温至 65°C increase to 65°C	65°C	时间 time	2.5H	3H	2.5H	2.5H	3H	测试条件 test condition	step6	step7	step8	step9	step10	湿度% humidity	80~96%	90~96%	90~96%	90~96%	90~96%	温度 temperature	降温至 25°C decrease to 25°C	25°C	降温至 -10°C decrease to -10°C	-10°C	升温至 25°C increase to 25°C	时间 time	2.5H	2H	0.5H	3H	0.5H
测试条件 test condition	step1	step2	step3	step4	step5																																												
湿度% humidity	90~96%	90~96%	80~96%	90~96%	90~96%																																												
温度 temperature	升温至 65°C increase to 65°C	65°C	降温至 25°C decrease to 25°C	升温至 65°C increase to 65°C	65°C																																												
时间 time	2.5H	3H	2.5H	2.5H	3H																																												
测试条件 test condition	step6	step7	step8	step9	step10																																												
湿度% humidity	80~96%	90~96%	90~96%	90~96%	90~96%																																												
温度 temperature	降温至 25°C decrease to 25°C	25°C	降温至 -10°C decrease to -10°C	-10°C	升温至 25°C increase to 25°C																																												
时间 time	2.5H	2H	0.5H	3H	0.5H																																												

Approval Specification for Thick Film Chip Resistors - Type **CR**

12. 上胶带剥离力测试 (Peel force of top cover tape)

上胶带以 200mm/分钟的速度，沿 165~180 度角的方向进行剥离，如下图所示。纸带的剥离力范围为 10g~70g；载带的剥离力范围为 30~100g

The top cover tape is pulled at a speed of 200 mm/min with the angle between the tape during peel and the direction of unreeling maintained at 165 to 180 degree as following picture. The peel force of paper carrier tape shall be 0.1N to 0.7N(10 to 70 g), the peel force of plastic carrier tape shall be 0.3N to 1N (30 to 100 g)

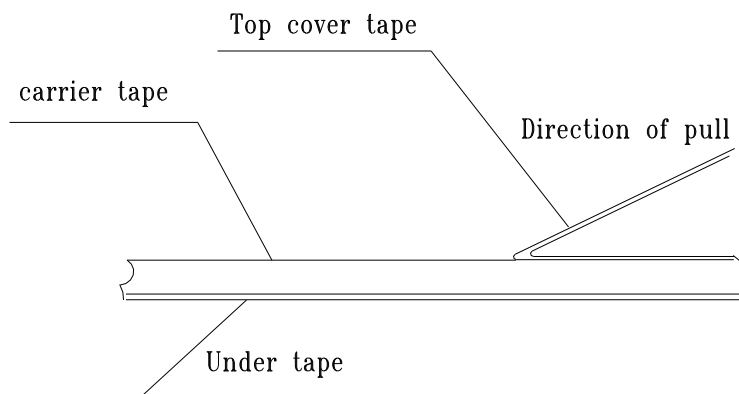

13. 焊盘尺寸 (Recommended land patterns):

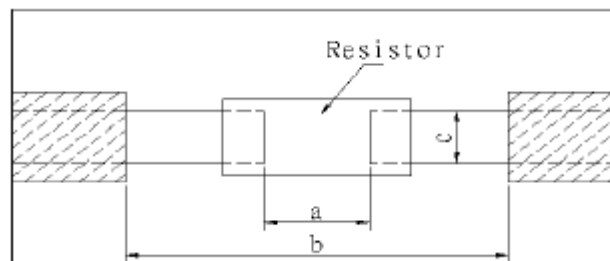

Type	Land pattern	Dimensions (mm)		
		a	b	c
	CR0201	0.25~0.3	0.7~0.9	0.3~0.4
	CR0402	0.5~0.6	1.4~1.6	0.4~0.6
	CR0603	0.7~0.9	2.0~2.2	0.8~1.0
	CR0805	1.0~1.4	3.2~3.8	0.9~1.4
	CR1206	2.0~2.4	4.4~5.0	1.2~1.8
	CR1210	2.0~2.4	4.4~5.0	2.3~3.5
	CR1812	2.8~3.2	7.6~8.6	2.3~3.5
	CR2010	3.3~3.7	5.7~6.5	2.3~3.5
	CR2512	3.6~4.0	7.6~8.6	2.3~3.5

Approval Specification for Thick Film Chip Resistors - Type **CR**

14. 焊接 (soldering)

14.1 建议回流焊曲线 (Recommend reflow soldering profile)

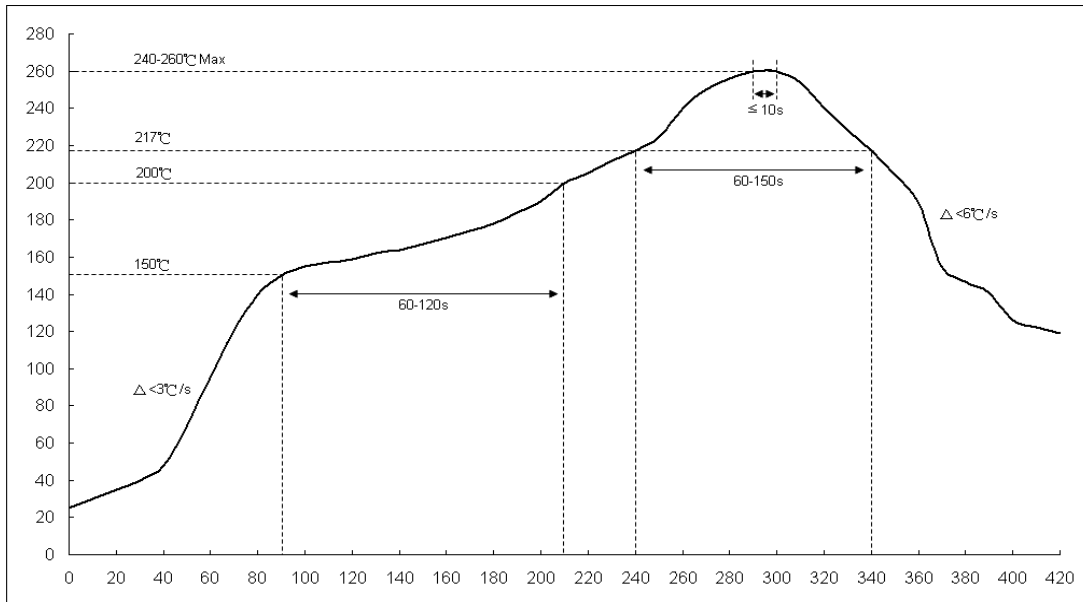

14.2 建议波峰焊曲线 (Recommend wave soldering profile)

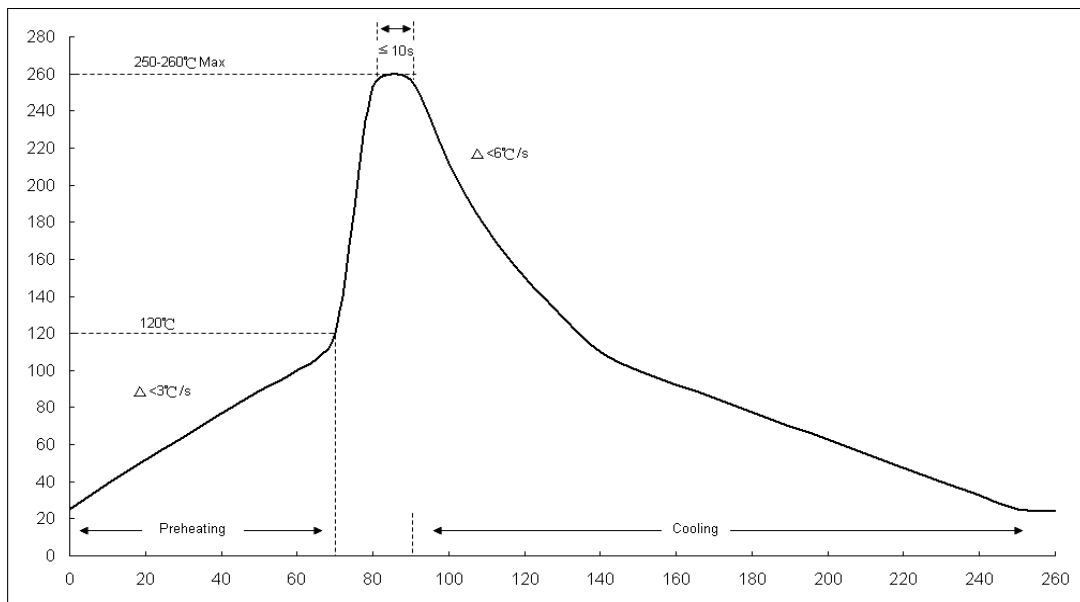

14.3 手工焊温度 (hand soldering temperature)

烙鐵溫度 $350 \pm 10^{\circ}\text{C}$ 3 秒之內，避免烙鐵接觸電阻本體

The iron temperature is $350 \pm 10^{\circ}\text{C}$, hand soldering time less than 3S. Avoid solder iron tip direct touch the components body.