



PESD5Zx series

Low capacitance unidirectional ESD protection diodes

Rev. 02 — 4 April 2008

Product data sheet

1. Product profile

1.1 General description

Low capacitance unidirectional ElectroStatic Discharge (ESD) protection diodes in a SOD523 (SC-79) ultra small and flat lead Surface-Mounted Device (SMD) plastic package designed to protect one signal line from the damage caused by ESD and other transients.

Table 1. Product overview

Type number	Package		Configuration
	Nexperia	JEITA	
PESD5Z2.5	SOD523	SC-79	single
PESD5Z3.3			
PESD5Z5.0			
PESD5Z6.0			
PESD5Z7.0			
PESD5Z12			

1.2 Features

- ESD protection of one line
- Low diode capacitance
- Max. peak pulse power: $P_{PP} = 260 \text{ W}$
- Low clamping voltage: $V_{CL} = 15 \text{ V}$
- Low leakage current: $I_{RM} < 1 \text{ nA}$
- ESD protection up to 30 kV
- IEC 61000-4-2; level 4 (ESD)
- IEC 61000-4-5 (surge); $I_{PP} = 20 \text{ A}$

1.3 Applications

- Computers and peripherals
- Audio and video equipment
- Cellular handsets and accessories
- 10/100/1000 Mbit/s Ethernet
- Communication systems
- Portable electronics
- Subscriber Identity Module (SIM) card protection
- FireWire
- High-speed data lines

1.4 Quick reference data

Table 2. Quick reference data

$T_{amb} = 25\text{ }^{\circ}\text{C}$ unless otherwise specified.

Symbol	Parameter	Conditions	Min	Typ	Max	Unit
Per diode						
V_{RWM}	reverse standoff voltage					
	PESD5Z2.5		-	-	2.5	V
	PESD5Z3.3		-	-	3.3	V
	PESD5Z5.0		-	-	5.0	V
	PESD5Z6.0		-	-	6.0	V
	PESD5Z7.0		-	-	7.0	V
	PESD5Z12		-	-	12.0	V
C_d	diode capacitance	$f = 1\text{ MHz}; V_R = 0\text{ V}$				
	PESD5Z2.5		-	229	300	pF
	PESD5Z3.3		-	172	200	pF
	PESD5Z5.0		-	89	150	pF
	PESD5Z6.0		-	78	150	pF
	PESD5Z7.0		-	69	150	pF
	PESD5Z12		-	35	75	pF

2. Pinning information

Table 3. Pinning

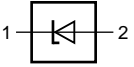
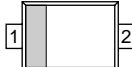
Pin	Description	Simplified outline	Symbol
1	cathode	[1]	 006aaa152
2	anode		

[1] The marking bar indicates the cathode.

3. Ordering information

Table 4. Ordering information

Type number	Package		Version
	Name	Description	
PESD5Z2.5	SC-79	plastic surface-mounted package; 2 leads	SOD523
PESD5Z3.3			
PESD5Z5.0			
PESD5Z6.0			
PESD5Z7.0			
PESD5Z12			

4. Marking

Table 5. Marking codes

Type number	Marking code
PESD5Z2.5	N7
PESD5Z3.3	N8
PESD5Z5.0	N9
PESD5Z6.0	NA
PESD5Z7.0	NB
PESD5Z12	NC

5. Limiting values

Table 6. Limiting values

In accordance with the Absolute Maximum Rating System (IEC 60134).

Symbol	Parameter	Conditions	Min	Max	Unit
Per diode					
P _{PP}	peak pulse power	t _p = 8/20 μs	[1][2]		
	PESD5Z2.5		-	260	W
	PESD5Z3.3		-	260	W
	PESD5Z5.0		-	180	W
	PESD5Z6.0		-	180	W
	PESD5Z7.0		-	180	W
	PESD5Z12		-	200	W
I _{PP}	peak pulse current	t _p = 8/20 μs	[1][2]		
	PESD5Z2.5		-	20	A
	PESD5Z3.3		-	20	A
	PESD5Z5.0		-	10	A
	PESD5Z6.0		-	10	A
	PESD5Z7.0		-	10	A
	PESD5Z12		-	6	A
Per device					
T _j	junction temperature		-	150	°C
T _{amb}	ambient temperature		-65	+150	°C
T _{stg}	storage temperature		-65	+150	°C

[1] Non-repetitive current pulse 8/20 μs exponential decay waveform according to IEC 61000-4-5.

[2] Measured from pin 1 to 2.

Table 7. ESD maximum ratings

Symbol	Parameter	Conditions	Min	Max	Unit
Per diode					
V_{ESD}	electrostatic discharge voltage				
	PESD5Zx series	IEC 61000-4-2 (contact discharge)	[1][2] -	30	kV
		machine model	-	400	V
		MIL-STD-883 (human body model)	-	10	kV

[1] Device stressed with ten non-repetitive ESD pulses.

[2] Measured from pin 1 to 2.

Table 8. ESD standards compliance

Standard	Conditions
Per diode	
IEC 61000-4-2; level 4 (ESD)	> 15 kV (air); > 8 kV (contact)
MIL-STD-883; class 3 (human body model)	> 4 kV

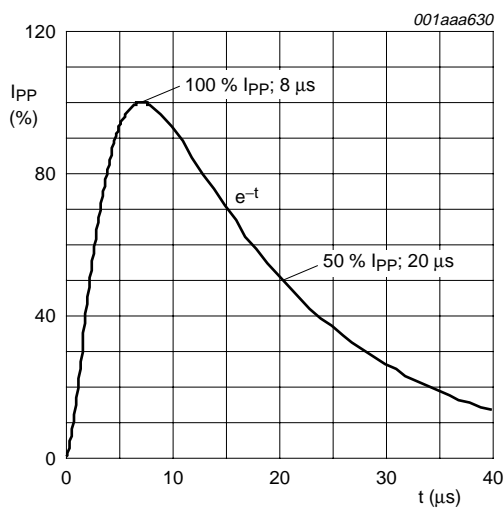

Fig 1. 8/20 μ s pulse waveform according to IEC 61000-4-5

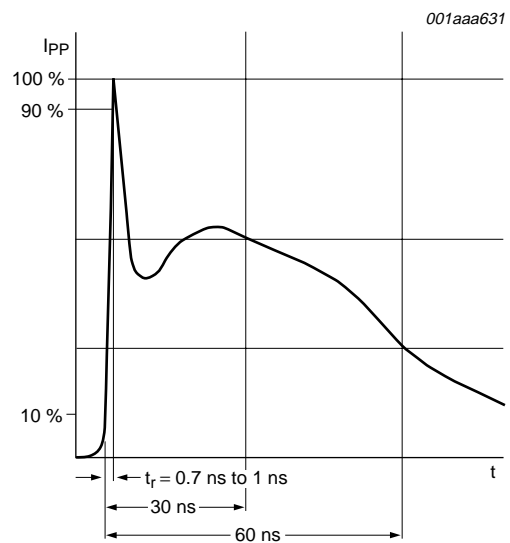

Fig 2. ESD pulse waveform according to IEC 61000-4-2

6. Characteristics

Table 9. Characteristics

$T_{amb} = 25\text{ }^{\circ}\text{C}$ unless otherwise specified.

Symbol	Parameter	Conditions	Min	Typ	Max	Unit
Per diode						
V_{RWM}	reverse standoff voltage					
	PESD5Z2.5		-	-	2.5	V
	PESD5Z3.3		-	-	3.3	V
	PESD5Z5.0		-	-	5.0	V
	PESD5Z6.0		-	-	6.0	V
	PESD5Z7.0		-	-	7.0	V
	PESD5Z12		-	-	12.0	V
I_{RM}	reverse leakage current					
	PESD5Z2.5	$V_{RWM} = 2.5\text{ V}$	-	0.5	6	μA
	PESD5Z3.3	$V_{RWM} = 3.3\text{ V}$	-	8	50	nA
	PESD5Z5.0	$V_{RWM} = 5.0\text{ V}$	-	5	50	nA
	PESD5Z6.0	$V_{RWM} = 6.0\text{ V}$	-	2	10	nA
	PESD5Z7.0	$V_{RWM} = 7.0\text{ V}$	-	< 1	10	nA
	PESD5Z12	$V_{RWM} = 12.0\text{ V}$	-	< 1	10	nA
V_{BR}	breakdown voltage	$I_R = 1\text{ mA}$				
	PESD5Z2.5		4	-	-	V
	PESD5Z3.3		5	-	-	V
	PESD5Z5.0		6.2	-	-	V
	PESD5Z6.0		6.8	-	-	V
	PESD5Z7.0		7.5	-	-	V
	PESD5Z12		14.1	-	-	V
C_d	diode capacitance	$f = 1\text{ MHz}; V_R = 0\text{ V}$				
	PESD5Z2.5		-	229	300	pF
	PESD5Z3.3		-	172	200	pF
	PESD5Z5.0		-	89	150	pF
	PESD5Z6.0		-	78	150	pF
	PESD5Z7.0		-	69	150	pF
	PESD5Z12		-	35	75	pF
V_{CL}	clamping voltage	$I_{PP} = 5\text{ A}$	[1][2]			
	PESD5Z2.5		-	8	9	V
	PESD5Z3.3		-	8	10	V
	PESD5Z5.0		-	12	13	V
	PESD5Z6.0		-	12	13	V
	PESD5Z7.0		-	14	15	V
	PESD5Z12		-	27	30	V

Table 9. Characteristics ...continued

$T_{amb} = 25\text{ }^{\circ}\text{C}$ unless otherwise specified.

Symbol	Parameter	Conditions	Min	Typ	Max	Unit
V_{CL}	clamping voltage		[1][2]			
	PESD5Z2.5	$I_{PP} = 20\text{ A}$	-	-	15	V
	PESD5Z3.3	$I_{PP} = 20\text{ A}$	-	-	18	V
	PESD5Z5.0	$I_{PP} = 10\text{ A}$	-	-	18	V
	PESD5Z6.0	$I_{PP} = 10\text{ A}$	-	-	18	V
	PESD5Z7.0	$I_{PP} = 10\text{ A}$	-	-	19	V
	PESD5Z12	$I_{PP} = 6\text{ A}$	-	-	35	V
r_{dif}	differential resistance	$I_R = 5\text{ mA}$				
	PESD5Z2.5		-	-	60	Ω
	PESD5Z3.3		-	-	10	Ω
	PESD5Z5.0		-	-	15	Ω
	PESD5Z6.0		-	-	15	Ω
	PESD5Z7.0		-	-	15	Ω
	PESD5Z12		-	-	40	Ω

[1] Non-repetitive current pulse 8/20 μs exponential decay waveform according to IEC 61000-4-5.

[2] Measured from pin 1 to 2.

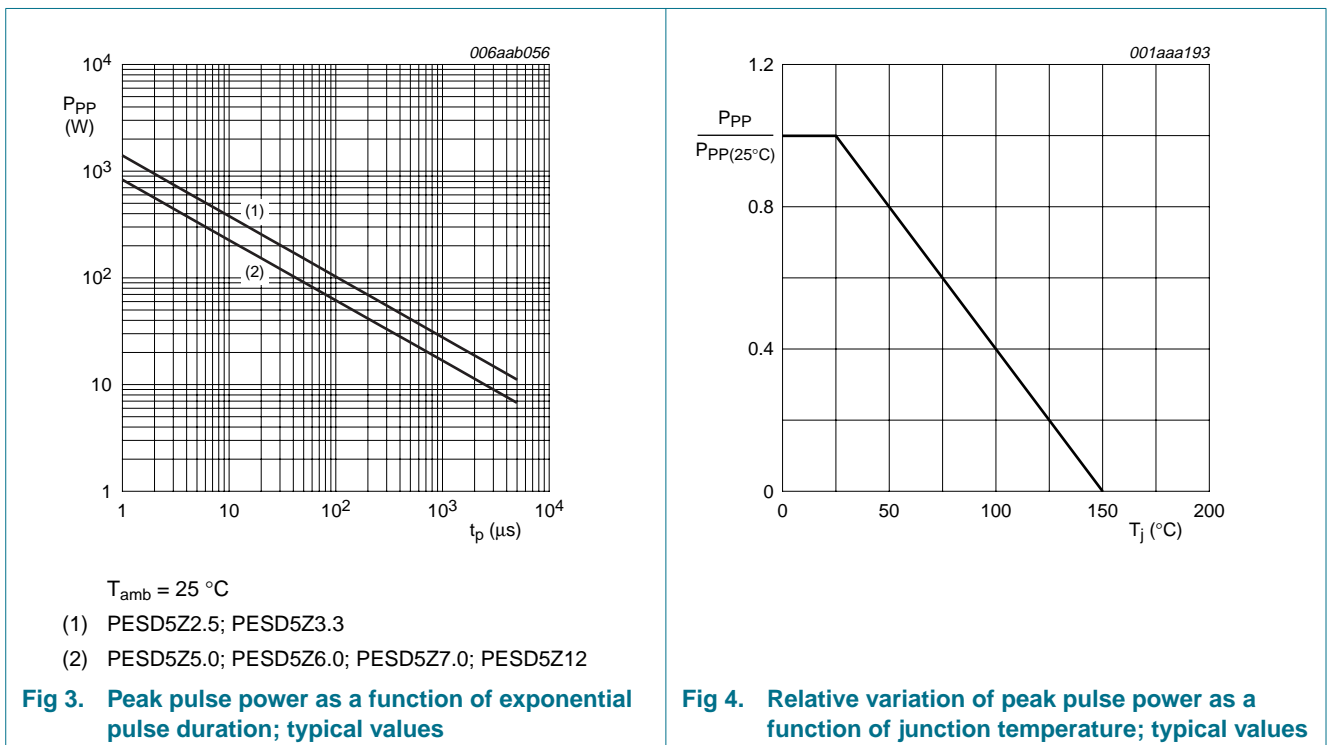

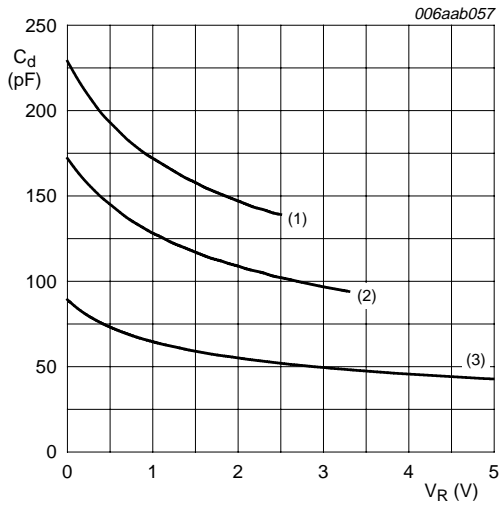

f = 1 MHz; T_{amb} = 25 °C
 (1) PESD5Z2.5
 (2) PESD5Z3.3
 (3) PESD5Z5.0

Fig 5. Diode capacitance as a function of reverse voltage; typical values

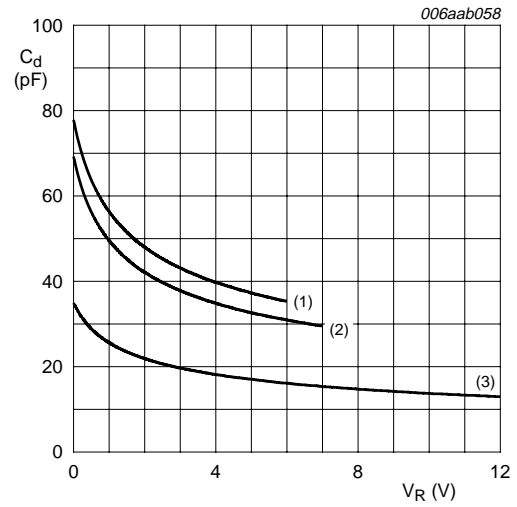

f = 1 MHz; T_{amb} = 25 °C
 (1) PESD5Z6.0
 (2) PESD5Z7.0
 (3) PESD5Z12

Fig 6. Diode capacitance as a function of reverse voltage; typical values

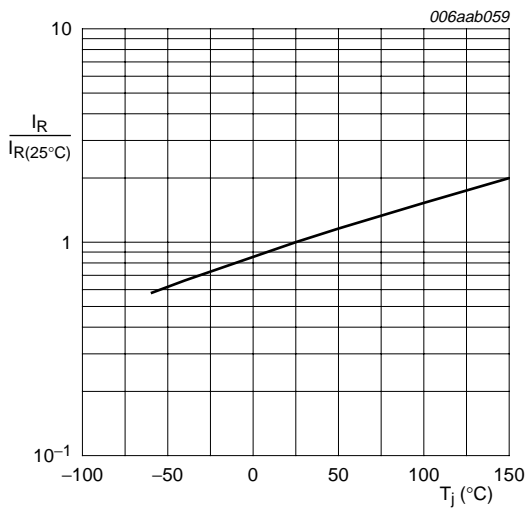

PESD5Z2.5; V_{RWM} = 2.5 V
 PESD5Z3.3; V_{RWM} = 3.3 V
 I_R is less than 50 nA at 150 °C for:
 PESD5Z5.0; V_{RWM} = 5.0 V
 PESD5Z6.0; V_{RWM} = 6.0 V
 PESD5Z7.0; V_{RWM} = 7.0 V
 PESD5Z12; V_{RWM} = 12.0 V

Fig 7. Relative variation of reverse current as a function of junction temperature; typical values

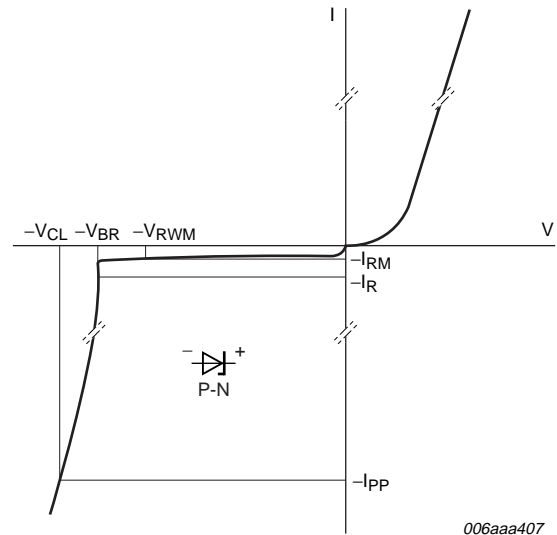
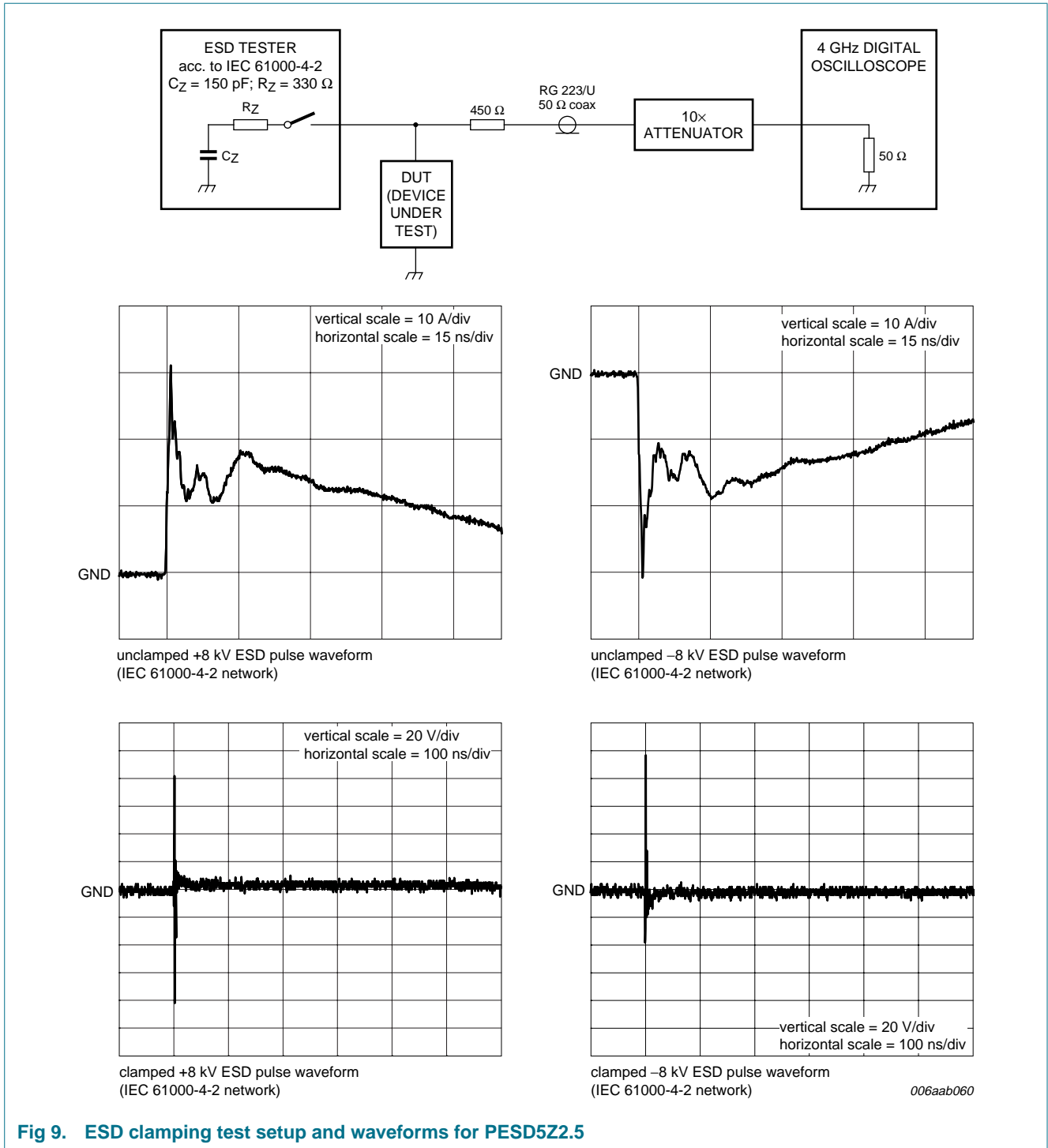

Fig 8. V-I characteristics for a unidirectional ESD protection diode



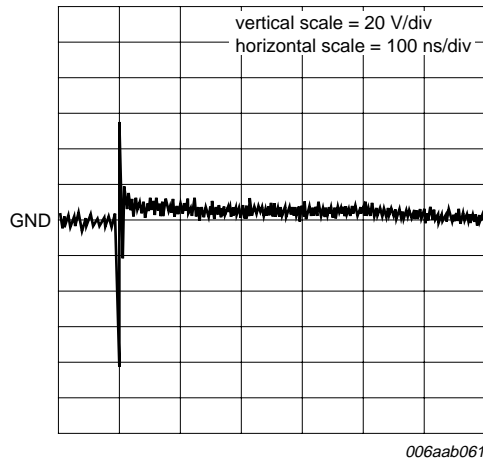

Fig 10. PESD5Z3.3: Clamped +8 kV ESD pulse waveform (IEC 61000-4-2 network)

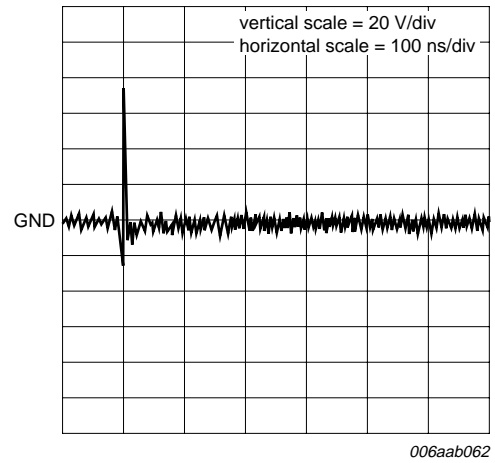

Fig 11. PESD5Z3.3: Clamped -8 kV ESD pulse waveform (IEC 61000-4-2 network)

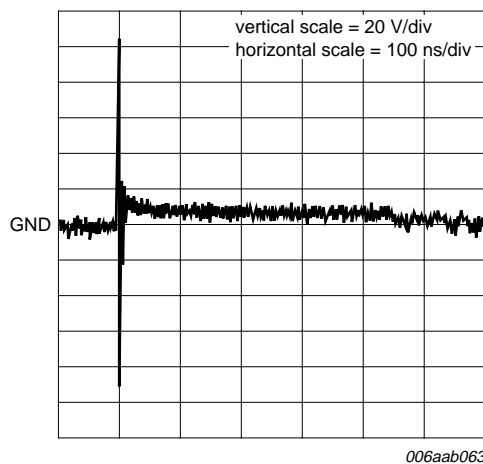

Fig 12. PESD5Z5.0: Clamped +8 kV ESD pulse waveform (IEC 61000-4-2 network)

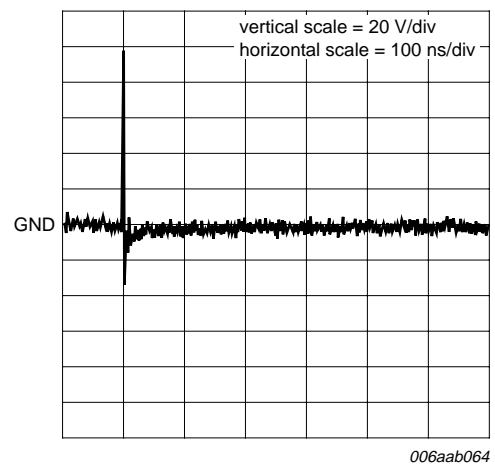

Fig 13. PESD5Z5.0: Clamped -8 kV ESD pulse waveform (IEC 61000-4-2 network)

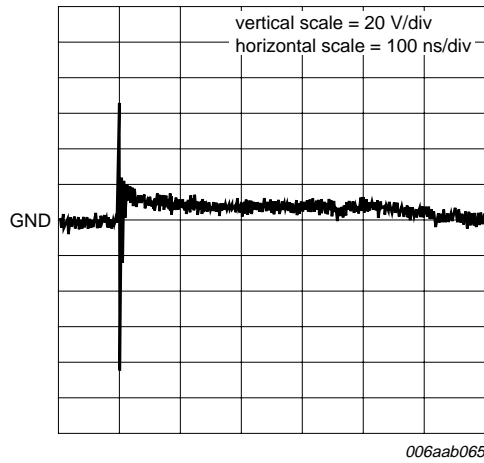

Fig 14. PESD5Z6.0: Clamped +8 kV ESD pulse waveform (IEC 61000-4-2 network)

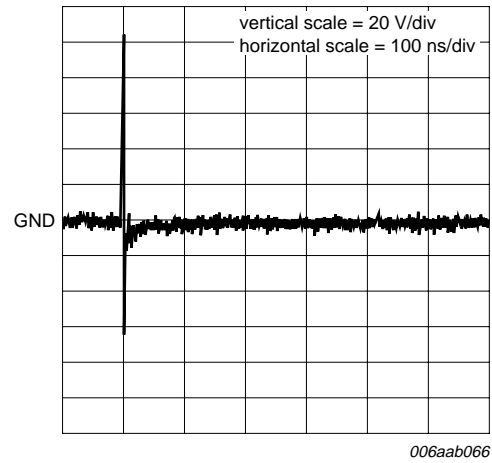

Fig 15. PESD5Z6.0: Clamped -8 kV ESD pulse waveform (IEC 61000-4-2 network)

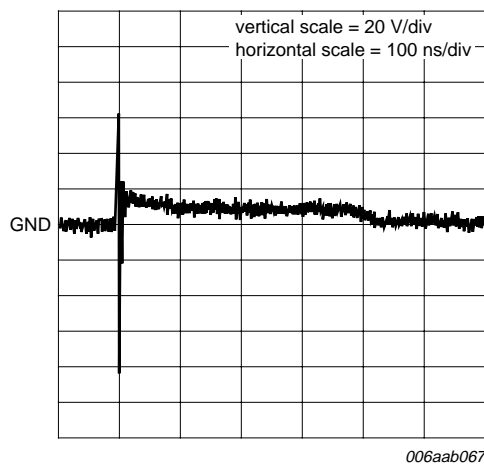

Fig 16. PESD5Z7.0: Clamped +8 kV ESD pulse waveform (IEC 61000-4-2 network)

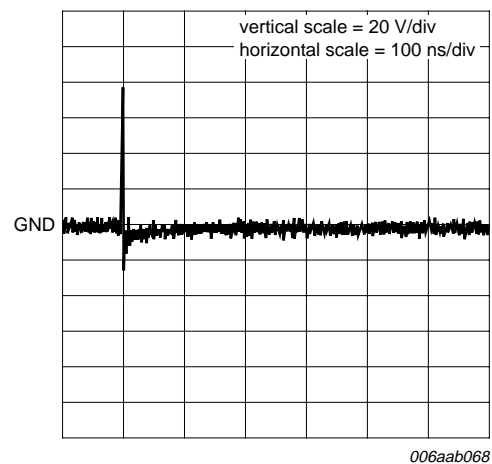
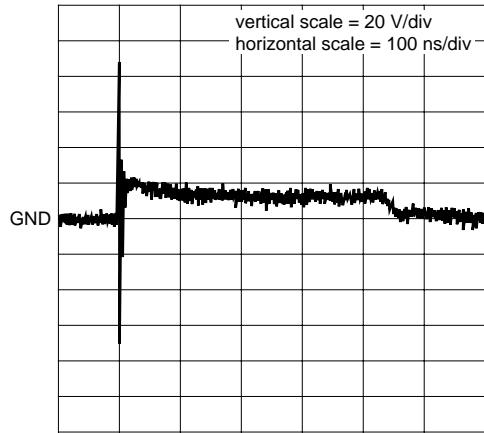
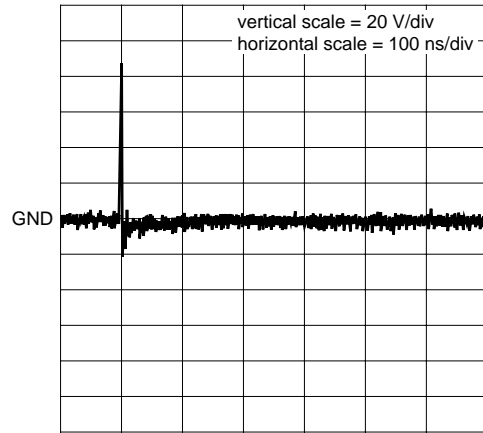

Fig 17. PESD5Z7.0: Clamped -8 kV ESD pulse waveform (IEC 61000-4-2 network)



006aab069

Fig 18. PESD5Z12: Clamped +8 kV ESD pulse waveform (IEC 61000-4-2 network)



006aab070

Fig 19. PESD5Z12: Clamped -8 kV ESD pulse waveform (IEC 61000-4-2 network)

7. Application information

The PESD5Zx series is designed for the protection of one unidirectional data or signal line from the damage caused by ESD and surge pulses. The device may be used on lines where the signal polarities are either positive or negative with respect to ground. The PESD5Zx series provides a surge capability of 260 W per line for an 8/20 μ s waveform.

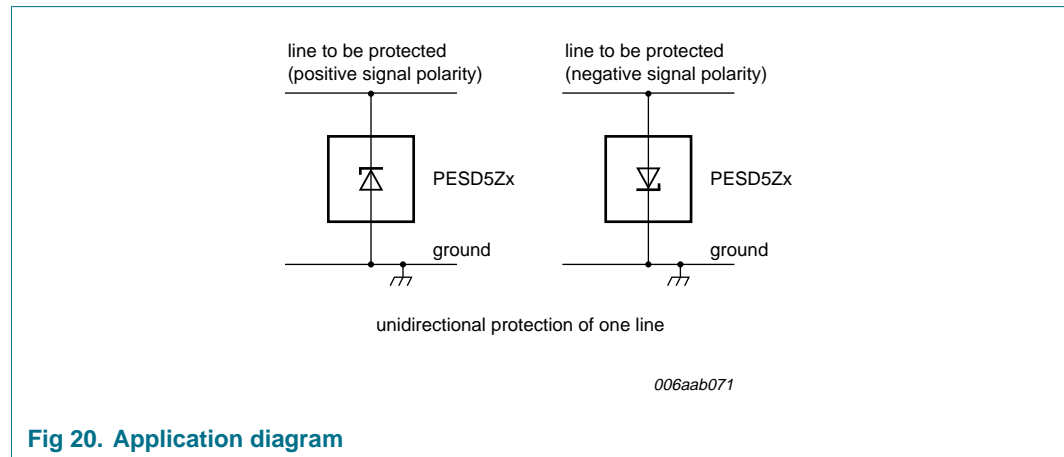

Fig 20. Application diagram

Circuit board layout and protection device placement

Circuit board layout is critical for the suppression of ESD, Electrical Fast Transient (EFT) and surge transients. The following guidelines are recommended:

1. Place the PESD5Zx as close to the input terminal or connector as possible.
2. The path length between the PESD5Zx and the protected line should be minimized.
3. Keep parallel signal paths to a minimum.
4. Avoid running protected conductors in parallel with unprotected conductors.
5. Minimize all Printed-Circuit Board (PCB) conductive loops including power and ground loops.
6. Minimize the length of the transient return path to ground.
7. Avoid using shared transient return paths to a common ground point.
8. Ground planes should be used whenever possible. For multilayer PCBs, use ground vias.

8. Package outline

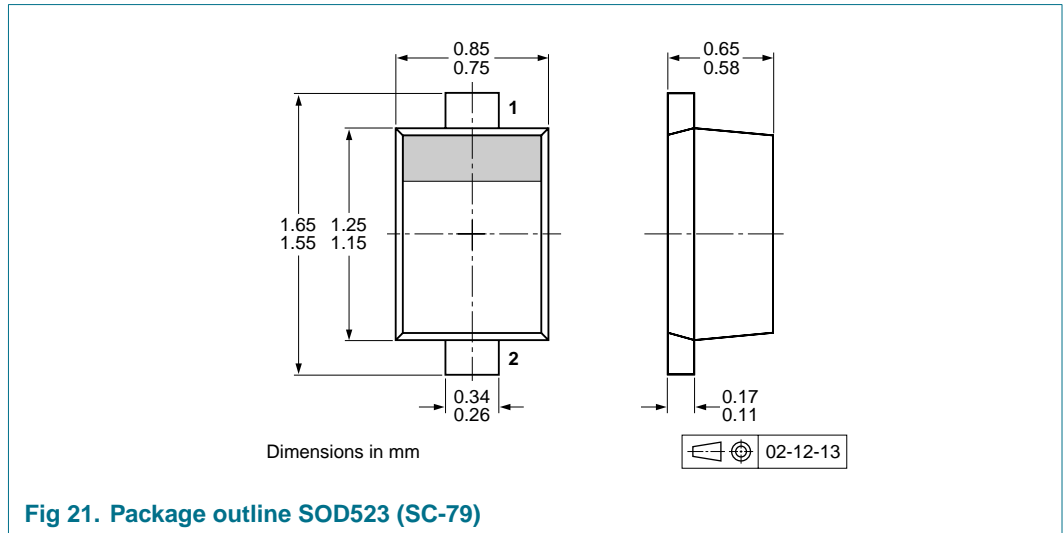

9. Packing information

Table 10. Packing methods

The indicated -xxx are the last three digits of the 12NC ordering code.^[1]

Type number	Package	Description	Packing quantity		
			3000	8000	10000
PESD5Z2.5	SOD523	2 mm pitch, 8 mm tape and reel	-	-315	-
		4 mm pitch, 8 mm tape and reel	-115	-	-135
PESD5Z3.3	SOD523	2 mm pitch, 8 mm tape and reel	-	-315	-
		4 mm pitch, 8 mm tape and reel	-115	-	-135
PESD5Z5.0	SOD523	2 mm pitch, 8 mm tape and reel	-	-315	-
		4 mm pitch, 8 mm tape and reel	-115	-	-135
PESD5Z6.0	SOD523	2 mm pitch, 8 mm tape and reel	-	-315	-
		4 mm pitch, 8 mm tape and reel	-115	-	-135
PESD5Z7.0	SOD523	2 mm pitch, 8 mm tape and reel	-	-315	-
		4 mm pitch, 8 mm tape and reel	-115	-	-135
PESD5Z12	SOD523	2 mm pitch, 8 mm tape and reel	-	-315	-
		4 mm pitch, 8 mm tape and reel	-115	-	-135

[1] For further information and the availability of packing methods, see [Section 13](#).

10. Soldering

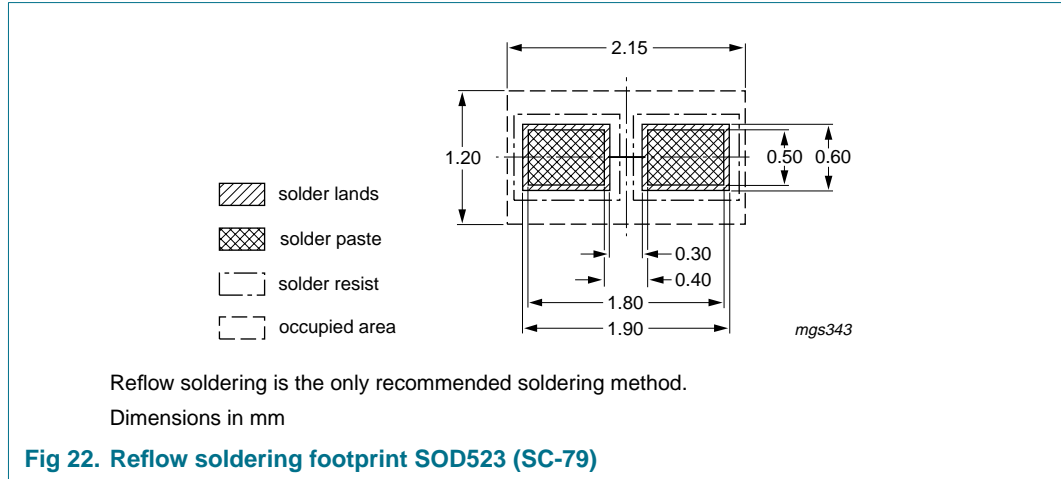

11. Revision history

Table 11. Revision history

Document ID	Release date	Data sheet status	Change notice	Supersedes
PESD5ZX_SER_2	20080404	Product data sheet	-	PESD5ZX_SER_1
Modifications:	• Table 10 : Type number updated to PESD5Z12			
PESD5ZX_SER_1	20070813	Product data sheet	-	-

12. Legal information

12.1 Data sheet status

Document status ^{[1][2]}	Product status ^[3]	Definition
Objective [short] data sheet	Development	This document contains data from the objective specification for product development.
Preliminary [short] data sheet	Qualification	This document contains data from the preliminary specification.
Product [short] data sheet	Production	This document contains the product specification.

[1] Please consult the most recently issued document before initiating or completing a design.

[2] The term 'short data sheet' is explained in section "Definitions".

[3] The product status of device(s) described in this document may have changed since this document was published and may differ in case of multiple devices. The latest product status information is available on the Internet at URL <http://www.nexperia.com>.

12.2 Definitions

Draft — The document is a draft version only. The content is still under internal review and subject to formal approval, which may result in modifications or additions. Nexperia does not give any representations or warranties as to the accuracy or completeness of information included herein and shall have no liability for the consequences of use of such information.

Short data sheet — A short data sheet is an extract from a full data sheet with the same product type number(s) and title. A short data sheet is intended for quick reference only and should not be relied upon to contain detailed and full information. For detailed and full information see the relevant full data sheet, which is available on request via the local Nexperia sales office. In case of any inconsistency or conflict with the short data sheet, the full data sheet shall prevail.

12.3 Disclaimers

General — Information in this document is believed to be accurate and reliable. However, Nexperia does not give any representations or warranties, expressed or implied, as to the accuracy or completeness of such information and shall have no liability for the consequences of use of such information.

Right to make changes — Nexperia reserves the right to make changes to information published in this document, including without limitation specifications and product descriptions, at any time and without notice. This document supersedes and replaces all information supplied prior to the publication hereof.

Suitability for use — Nexperia products are not designed, authorized or warranted to be suitable for use in medical, military, aircraft, space or life support equipment, nor in applications where failure or

malfunction of a Nexperia product can reasonably be expected to result in personal injury, death or severe property or environmental damage. Nexperia accepts no liability for inclusion and/or use of Nexperia products in such equipment or applications and therefore such inclusion and/or use is at the customer's own risk.

Applications — Applications that are described herein for any of these products are for illustrative purposes only. Nexperia makes no representation or warranty that such applications will be suitable for the specified use without further testing or modification.

Limiting values — Stress above one or more limiting values (as defined in the Absolute Maximum Ratings System of IEC 60134) may cause permanent damage to the device. Limiting values are stress ratings only and operation of the device at these or any other conditions above those given in the Characteristics sections of this document is not implied. Exposure to limiting values for extended periods may affect device reliability.

Terms and conditions of sale — Nexperia products are sold subject to the general terms and conditions of commercial sale, as published at <http://www.nexperia.com/profile/terms>, including those pertaining to warranty, intellectual property rights infringement and limitation of liability, unless explicitly otherwise agreed to in writing by Nexperia. In case of any inconsistency or conflict between information in this document and such terms and conditions, the latter will prevail.

No offer to sell or license — Nothing in this document may be interpreted or construed as an offer to sell products that is open for acceptance or the grant, conveyance or implication of any license under any copyrights, patents or other industrial or intellectual property rights.

12.4 Trademarks

Notice: All referenced brands, product names, service names and trademarks are the property of their respective owners.

13. Contact information

For additional information, please visit: <http://www.nexperia.com>

For sales office addresses, send an email to: salesaddresses@nexperia.com

14. Contents

1	Product profile	1
1.1	General description	1
1.2	Features	1
1.3	Applications	1
1.4	Quick reference data	2
2	Pinning information	2
3	Ordering information	2
4	Marking	3
5	Limiting values	3
6	Characteristics	5
7	Application information	12
8	Package outline	13
9	Packing information	13
10	Soldering	14
11	Revision history	15
12	Legal information	16
12.1	Data sheet status	16
12.2	Definitions	16
12.3	Disclaimers	16
12.4	Trademarks	16
13	Contact information	16
14	Contents	17