

1a 10A TV-5 rated power relays

LK-P RELAYS



RoHS compliant

FEATURES

- High switching capacity: 10 A 277V AC**
- High insulation resistance between contact and coil**
 - Creepage distance and clearances between contact and coil: Min. 6 mm .236 inch (In compliance with IEC60065)
 - Surge withstand voltage between contact and coil: 10,000 V
- Popular terminal pitch in AV equipment field**
- Space-saving slim type**
Base area: Width 11 × Length 24 mm
Width .433 × Length .945 inch

- Conforms to the various safety standards**
UL, CSA, VDE, TÜV and SEMKO approved

TYPICAL APPLICATIONS

- **Audio visual equipment**
TVs, VTRs
- **Office equipment**
LBP, CRT
- **Home appliances**
Refrigerator, Air conditioner

ORDERING INFORMATION

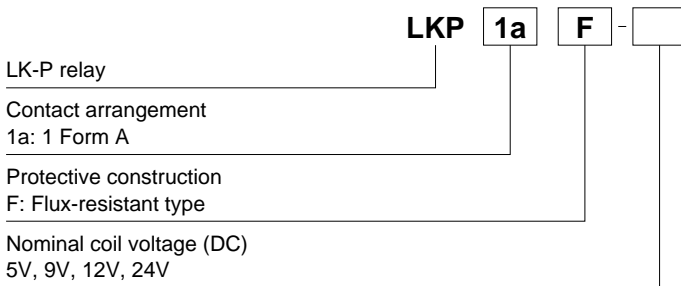

Notes: Certified by UL, CSA, TÜV and SEMKO
VDE approved type is available. Please consult us for details.

TYPES

Contact arrangement	Nominal coil voltage	Part No.
1 Form A	5V DC	LKP1aF-5V
	9V DC	LKP1aF-9V
	12V DC	LKP1aF-12V
	24V DC	LKP1aF-24V

Notes: 1. Standard packing Carton: 100 pcs. Case: 500 pcs.
2. 18 V DC types are also available. Please consult us for details.

RATING

1. Coil data

Nominal coil voltage	Pick-up voltage (at 20°C 68°F)	Drop-out voltage (at 20°C 68°F)	Nominal operating current [±10%] (at 20°C 68°F)	Coil resistance [±10%] (at 20°C 68°F)	Nominal operating power	Max. applied voltage (at 20°C 68°F)
5V DC	70%V or less of nominal voltage (Initial)	10%V or more of nominal voltage (Initial)	106.4mA	47Ω	530mW	6.5V DC
9V DC			58.8mA	153Ω		11.7V DC
12V DC			44.2mA	272Ω		15.6V DC
24V DC			22.1mA	1,087Ω		31.2V DC

2. Specifications

Characteristics	Item	Specifications	
Contact	Arrangement	1 Form A	
	Contact resistance (Initial)	Max. 100 mΩ (By voltage drop 6 V DC 1A)	
	Contact material	AgSnO ₂ type	
Rating	Nominal switching capacity (resistive load)	10A 277V AC, 5A 30V DC	
	Max. switching power (resistive load)	2,770VA, 150W	
	Max. switching voltage	277V AC, 30V DC	
	Max. switching current	10A (AC), 5A (DC)	
	Min. switching capacity (reference value)*1	100mA, 5V DC	
Electrical characteristics	Insulation resistance (Initial)	Min. 1,000MΩ (at 500V DC) Measurement at same location as "Breakdown voltage" section.	
	Breakdown voltage (Initial)	Between open contacts	1,000 Vrms for 1 min. (Detection current: 10 mA)
		Between contact and coil	4,000 Vrms for 1 min. (Detection current: 10 mA)
	Temperature rise (coil)	Max. 45°C 113°F (By resistive method, nominal coil voltage applied to the coil; contact carrying current: 10A, at 70°C 158°F)	
	Surge breakdown voltage*2 (Between contact and coil) (Initial)	10,000 V	
	Operate time (at nominal voltage) (at 20°C 68°F) (Initial)	Max. 15 ms (excluding contact bounce time.)	
	Release time (at nominal voltage) (at 20°C 68°F) (Initial)	Max. 5 ms (excluding contact bounce time) (Without diode)	
Mechanical characteristics	Shock resistance	Functional	200 m/s ² (Half-wave pulse of sine wave: 11 ms; detection time: 10μs.)
		Destructive	1,000 m/s ² (Half-wave pulse of sine wave: 6 ms.)
	Vibration resistance	Functional	10 to 55 Hz at double amplitude of 1.5 mm (Detection time: 10μs.)
		Destructive	10 to 55 Hz at double amplitude of 1.5 mm
Expected life	Mechanical (at 180 times/min.)	Min. 2×10 ⁶	
	Electrical	Min. 10 ⁵ (ON/OFF = 1.5s : 1.5s at rated load)	
Conditions	Conditions for operation, transport and storage*3	Ambient temperature: -40°C to +70°C -40°F to +158°F, Humidity: 5 to 85% R.H. (Not freezing and condensing at low temperature), Air pressure: 86 to 106kPa	
	Max. operating speed	20 times/min. (at nominal switching capacity)	
Unit weight		Approx. 12 g .42 oz	

* Specifications will vary with foreign standards certification ratings.

Notes: *1. This value can change due to the switching frequency, environmental conditions, and desired reliability level, therefore it is recommended to check this with the actual load.

*2. Wave is standard shock voltage of ±1.2×50μs according to JEC-212-1981

*3. The upper limit of the ambient temperature is the maximum temperature that can satisfy the coil temperature rise value. Refer to Usage, transport and storage conditions in NOTES.

REFERENCE DATA

1. Max. switching power

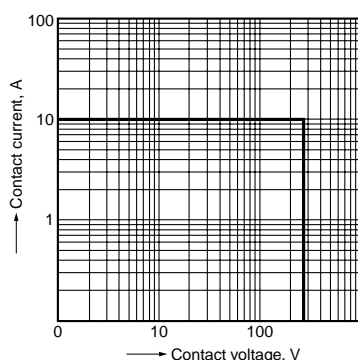

2. Coil temperature rise

Sample: LKP1aF-12V, 6 pcs.
Point measured: coil inside
Contact current: 5 A, 10 A

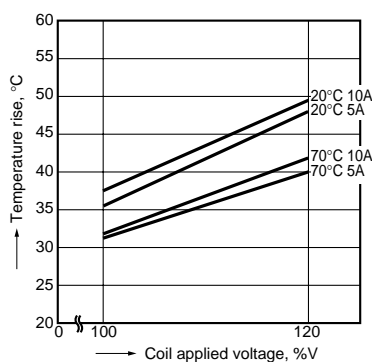

3. Ambient temperature characteristics and coil applied voltage

Contact current: 10 A

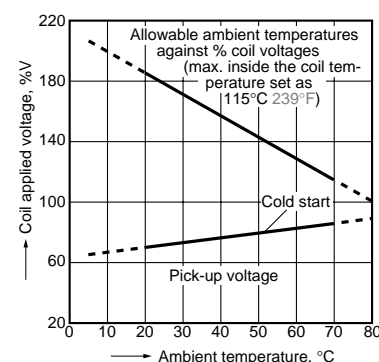

LK-P

4. Life curve

Operation frequency: 20 times/min.

(ON/OFF = 1.5s: 1.5s)

Ambient temperature: room temperature

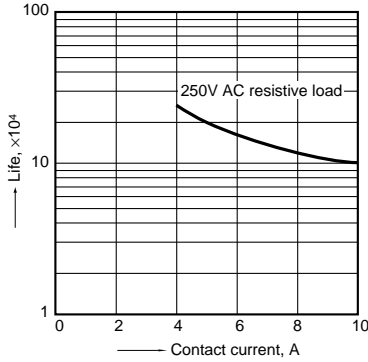

5. Electrical life test

(10 A 277 V AC, resistive load)

Sample: LKP1aF-12V, 6 pcs.

Operation frequency: 20 times/min.

(ON/OFF = 1.5s: 1.5s)

Ambient temperature: 20°C 68°F

Circuit:

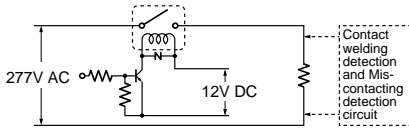

Change of pick-up and drop-out voltage

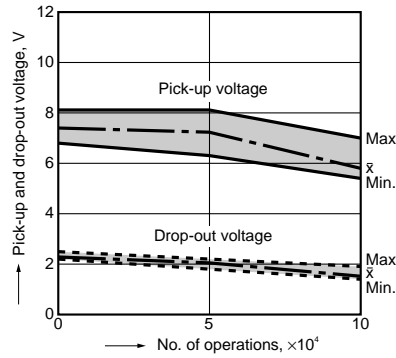

Change of contact resistance

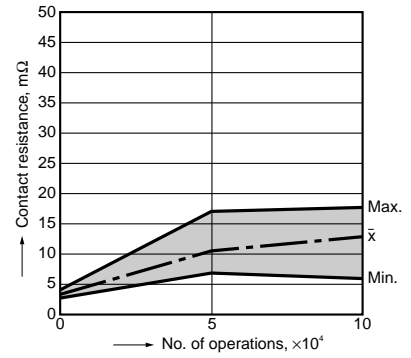

DIMENSIONS (mm inch)

The CAD data of the products with a **CAD Data** mark can be downloaded from: <http://industrial.panasonic.com/ac/e/>

CAD Data

External dimensions

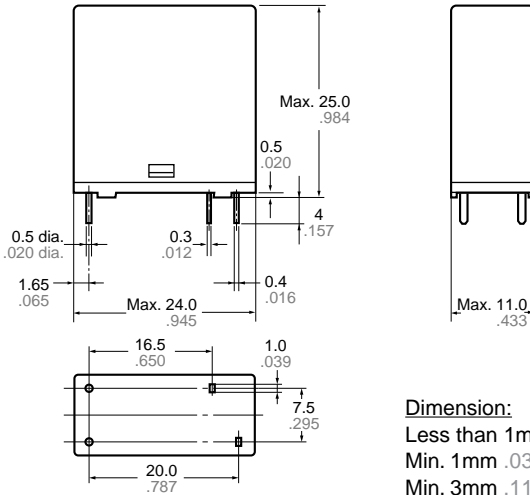

PC board pattern (Bottom view)

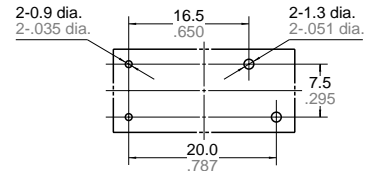

Tolerance: $\pm 0.1 \pm 0.004$

Schematic (Bottom view)



Dimension:

Less than 1mm .039inch:

Min. 1mm .039inch less than 3mm .118 inch: $\pm 0.2 \pm 0.008$

Min. 3mm .118 inch:

General tolerance

$\pm 0.1 \pm 0.004$

$\pm 0.2 \pm 0.008$

$\pm 0.3 \pm 0.012$

SAFETY STANDARDS

UL/C-UL (Recognized)		CSA (Certified)		VDE (Certified)		TV rating (UL/CSA)		TÜV (Certified)		SEMKO (Certified)	
File No.	Contact rating	File No.	Contact rating	File No.	Contact rating	File No.	Rating	File No.	Rating	File No.	Contact rating
E43149	10A 277V AC 5A 30V DC	LR26550 etc.	10A 277V AC 5A 30V DC	40014390	10A 250V AC (cosφ=1.0)	UL E43149 CSA LR26550	TV-5	B 11 05 13461 299	10A 250V AC (cosφ=1.0) 5A 30V DC (0ms)	807779	3/100A 250V AC 5/40A 250V AC 10A 250V DC

For Cautions for Use.

Mouser Electronics

Authorized Distributor

Click to View Pricing, Inventory, Delivery & Lifecycle Information:

[Panasonic:](#)

[LKP1AF-12V](#) [LKP1AF-24V](#) [LKP1AF-5V](#) [LKP1AF-6V](#) [LKP1AF-9V](#)