

Switching Regulator Series

1ch Buck Converter with Integrated FET BD9F500QUZ EVK

BD9F500QUZ-EVK-001 (12V→1V, 5A)

Introduction

This user's guide describes the steps required to operate the EVK of BD9F500QUZ. This document includes description of peripheral components, operating instructions and reference data.

Description

BD9F500QUZ-EVK-001 uses BD9F500QUZ to output 1V from a 12V input voltage. The input voltage of the BD9F500QUZ is from 4.5V to 36V and the output voltage is configurable from 0.6V to 14V with external resistors. The operating frequency is selectable between 600 kHz, 1 MHz and 2.2 MHz. It is a fixed on-time controlled DC/DC converter that provides fast transient response. The light-load mode control improves efficiency at light loads which makes it ideal for devices that require less standby power. Built-in functions include variable soft start function which prevents inrush current at startup, UVLO (Under Voltage Lock Out), TSD (Thermal Shutdown Detection), OCP (Over Current Protection) and SCP (Short Circuit Protection).

Application

- Step-down power supplies for SoCs, FPGAs, microprocessors, etc.
- Printer (MFP / LBP / IJP / POS)
- Office Equipment
- Laptop PC
- USB Type-C Applications

EVK Operating Limits

Parameter	Min	Typ	Max	Units	Conditions
Input Voltage	4.5	12.0	36.0	V	
Output Voltage		1.0		V	
Maximum Output Current			5.0	A	
Switching Frequency		1		MHz	
Maximum Efficiency		81		%	Io = 2A
UVLO Threshold Voltage		4.2		V	VIN sweep up
UVLO Hysteresis Voltage		200		mV	

EVK Overview

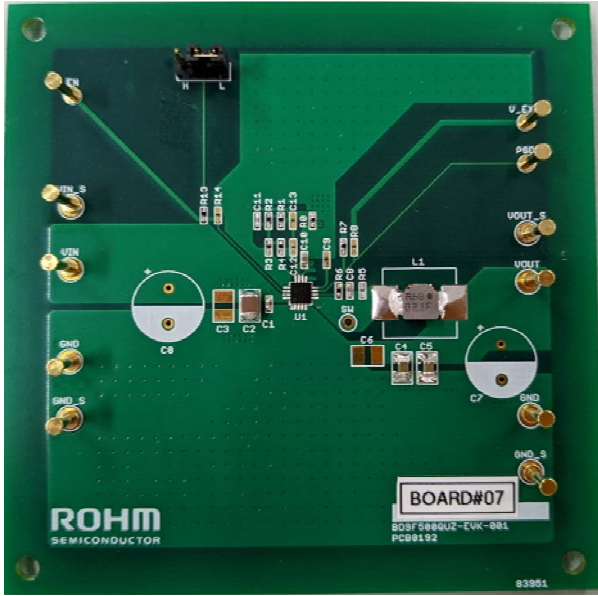

Figure 1. BD9F500QUZ-EVK-001 (Top View)

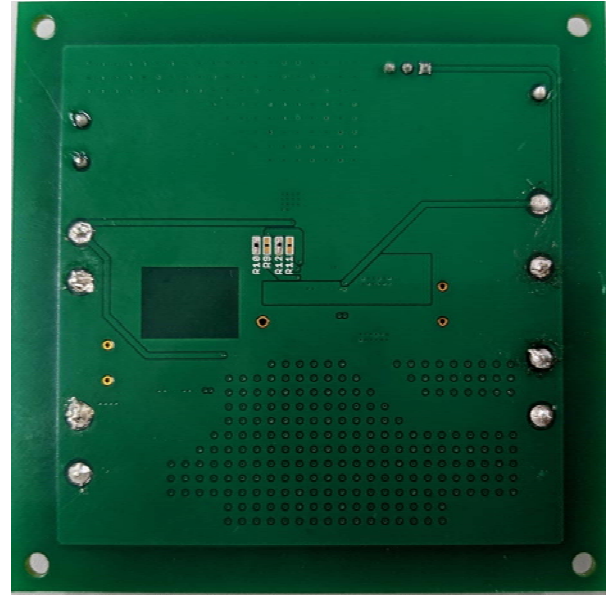

Figure 2. BD9F500QUZ-EVK-001 (Bottom View)

EVK Schematic

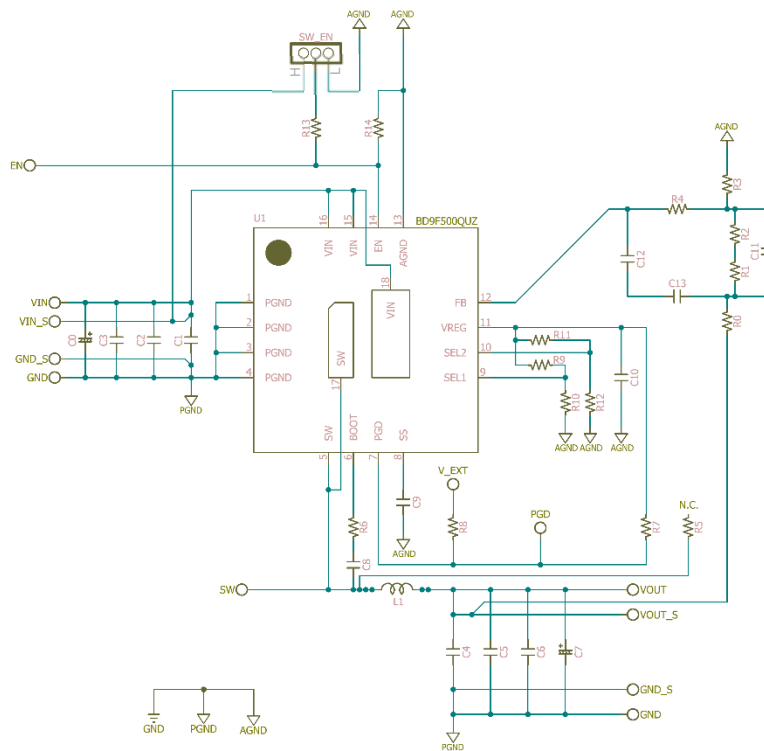

Figure 3. BD9F500QUZ-EVK-001 Schematic

Operating Procedures

1. Turn off the DC power supply power switch and connect the power supply's GND terminal to the GND terminal of the EVK.
2. Connect the positive terminal of the DC power supply to the VIN pin of the EVK.
3. Connect the load across the VOUT pin and the GND pin of the EVK. In the case of an electronic load, turn the load off.
4. Connect the voltmeter's positive terminal to the EVK's VOUT_S and the GND terminal to the EVK's GND_S.
5. Connect the SW_EN jumper to H (VIN).
6. Turn on the DC power supply. Make sure that the voltmeter reading is 1V.
7. Turn on the electronic load.

(Caution) This EVK does not support hot plug. Do not perform hot plug test.

Operating State Settings

Select the status of BD9F500QUZ as shown in Table 1 according to the EN pin voltage.

Table 1. EN Pin Settings

EN Pin Voltage	State
HIGH (≥ 1.2 V)	Enable
LOW (≤ 1.1 V)	Shutdown

Operating Mode Settings

The switching frequency of BD9F500QUZ is selected by SEL1 and SEL2 pins as shown in Table 2. This EVK is equipped with optimum parts for 1MHz switching frequency, a maximum output current of 5A, and a light load mode. When changing the operating frequency, it is necessary to change the parts.

Table 2. Switching Frequency Settings

SEL1 Condition	SEL2 Condition	Switching Frequency (Hz)	Maximum Output Current (A) ($I_{O\ MAX}$)	Operation Mode
GND	GND	1 MHz (Typ)	5	Light Load (LLM)
GND	OPEN			Fixed PWM
VREG	GND		3	Light Load (LLM)
VREG	OPEN			Fixed PWM
OPEN	GND	600 kHz (Typ)	5	Light Load (LLM)
OPEN	OPEN			Fixed PWM
GND	VREG		3	Light Load (LLM)
OPEN	VREG			Fixed PWM
VREG	VREG	2.2 MHz (Typ)	3	Fixed PWM

Parts List

Table 3. Parts List

Count	Parts No.	Type	Value	Description	Manufacturer's Part Number	Manufacturer	Configuration (mm)
1	U1	IC	-	Single Synchronous BUCK Converter	BD9F500QUZ	ROHM	3.0x 3.0
1	L1	Inductor	0.68μH	11A max, ±20%	FSD0518-H-R68M	Murata	5249
0	C0	Aluminum Electrolytic Capacitor	No mount	N/A	N/A	N/A	Φ10
1	C1	Ceramic Capacitor	0.1μF	50V, X5R, ±10%	UMK105BJ104KV-F	TAIYO YUDEN	1005
1	C2	Ceramic Capacitor	10μF	50V, X5R, ±20%	UMK325BJ106MM-P	TAIYO YUDEN	3225
0	C3	Ceramic Capacitor	No mount	N/A	N/A	N/A	3225
1	C4	Ceramic Capacitor	22μF	25V, X5R, ±20%	TMK212BBJ226MG-TT	TAIYO YUDEN	2012
1	C5	Ceramic Capacitor	22μF	25V, X5R, ±20%	TMK212BBJ226MG-TT	TAIYO YUDEN	2012
0	C6	Ceramic Capacitor	No mount	N/A	N/A	N/A	1608
0	C7	Aluminum Electrolytic Capacitor	No mount	N/A	N/A	N/A	Φ10
1	C8	Ceramic Capacitor	0.1μF	50V, X5R, ±10%	UMK105BJ104KV-F	TAIYO YUDEN	1005
0	C9	Ceramic Capacitor	No mount	N/A	N/A	N/A	1005
1	C10	Ceramic Capacitor	2.2μF	25V, X5R, ±20%	TMK105CBJ225MV-F	TAIYO YUDEN	1005
1	C11	Ceramic Capacitor	27pF	50V, C0G, ±5%	GRM035C1H270JA01	Murata	1005
0	C12	Ceramic Capacitor	No mount	N/A	N/A	N/A	1005
0	C13	Ceramic Capacitor	No mount	N/A	N/A	N/A	1005
1	R0	Resistor	0Ω	Jumper	MCR01MZPJ000	ROHM	1005
1	R1	Resistor	0Ω	Jumper	MCR01MZPJ000	ROHM	1005
1	R2	Resistor	180kΩ	50V, ±1%, 1/16W	MCR01MZPF1803	ROHM	1005
1	R3	Resistor	270kΩ	50V, ±1%, 1/16W	MCR01MZPF2703	ROHM	1005
1	R4	Resistor	0Ω	Jumper	MCR01MZPJ000	ROHM	1005
0	R5	Resistor	No mount	N/A	N/A	N/A	1005
1	R6	Resistor	0Ω	Jumper	MCR01MZPJ000	ROHM	1005
1	R7	Resistor	100kΩ	50V, ±1%, 1/16W	MCR01MZPF1003	ROHM	1005
0	R8	Resistor	No mount	N/A	N/A	N/A	1005
0	R9	Resistor	No mount	N/A	N/A	N/A	1005
1	R10	Resistor	0Ω	Jumper	MCR01MZPJ000	ROHM	1005

Parts List – Cont'd

Table 3. Parts List

Count	Parts No.	Type	Value	Description	Manufacturer's Part Number	Manufacturer	Configuration (mm)
0	R11	Resistor	No mount	N/A	N/A	N/A	1005
1	R12	Resistor	0Ω	Jumper	MCR01MZPJ000	ROHM	1005
1	R13	Resistor	0Ω	Jumper	MCR01MZPJ000	ROHM	1005
0	R14	Resistor	No mount	N/A	N/A	N/A	1005
1	SW_EN	-	-	-	1x3 Header Connection, Pitch 2.54	N/A	-
11	VIN, VIN_S, VOUT, VOUT_S, GND, GND_S, EN, SW, PGD, V_EXT	Test Pin	-	-	ST-2-2	MAC8	-

EVK PCB Layout

EVK PCB Information

Number of Layers	Material	Board Size	Copper Thickness
4	FR-4	85mm x 85mm x 1.6mmt	2oz (70 μ m) *Top, Bottom Layer 1oz (35 μ m) *Middle Layers

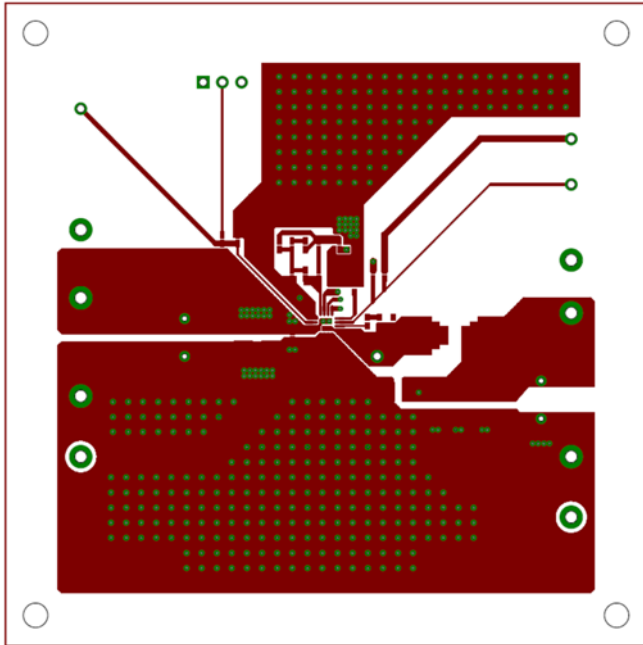

Figure 4. Top Layer Layout
(Top View)

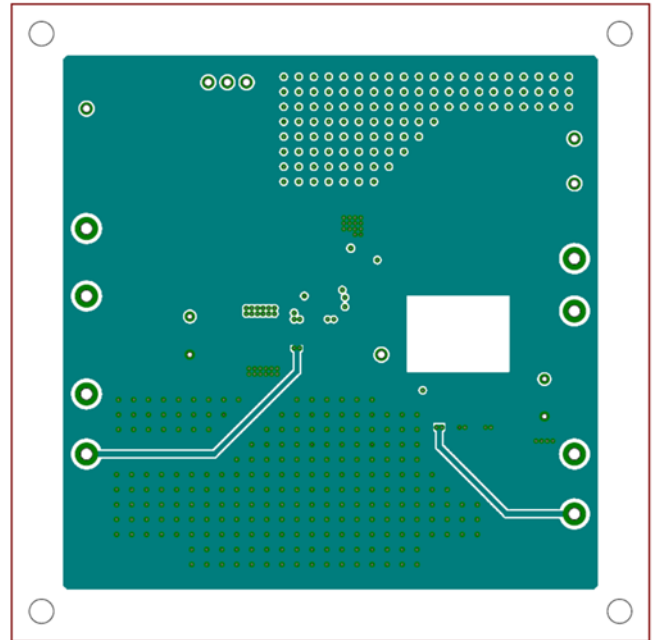

Figure 5. Middle1 Layer Layout
(Top View)

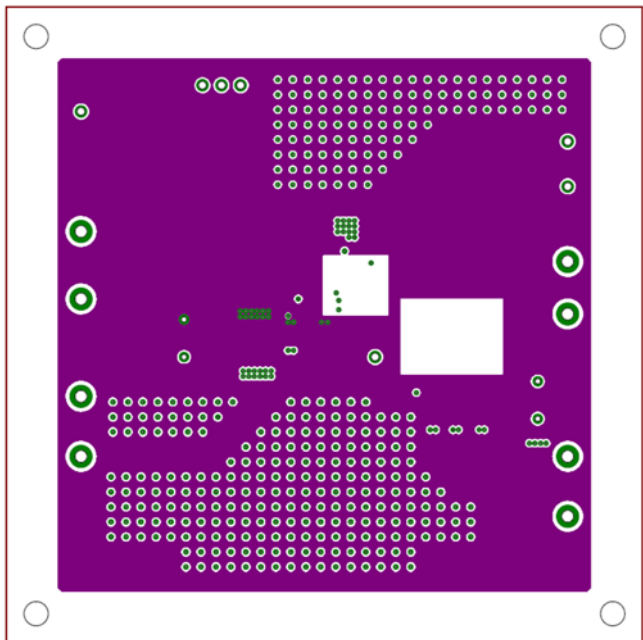

Figure 6. Middle2 Layer Layout
(Top View)

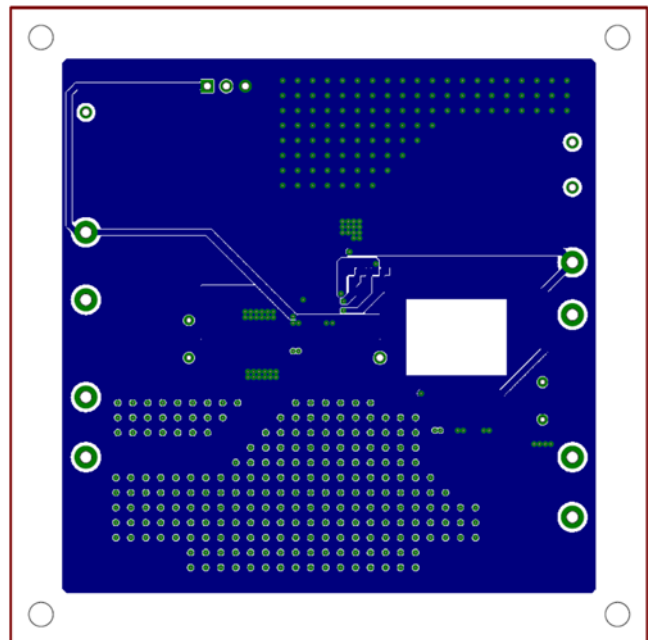

Figure 7. Bottom Layer Layout
(Top View)

Reference Application Curves

Ta = 25°C, VIN = 12V, EN = VIN, unless otherwise specified

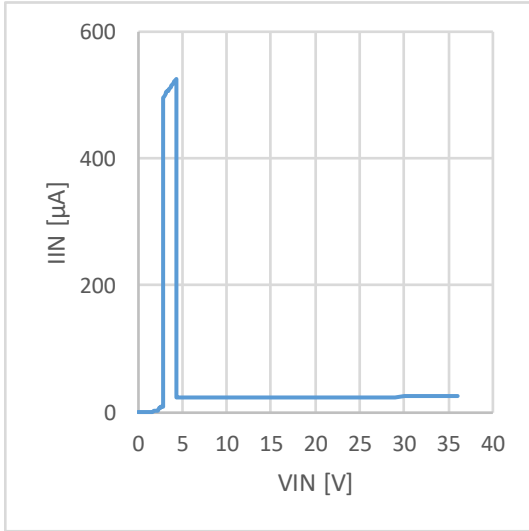

Figure 8. Current Consumption vs VIN
(Io = 0mA)

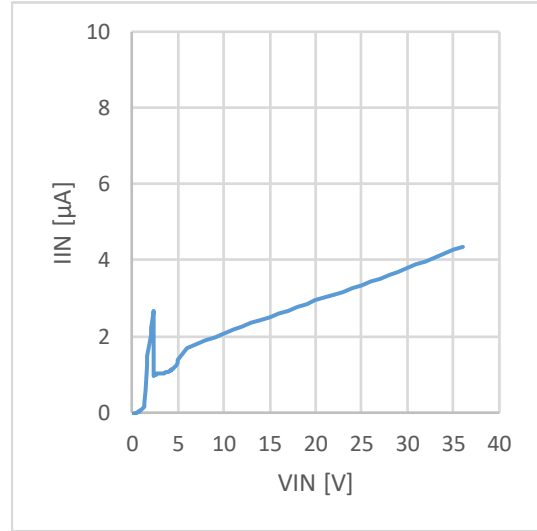

Figure 9. Shutdown Current vs VIN
(EN=GND)

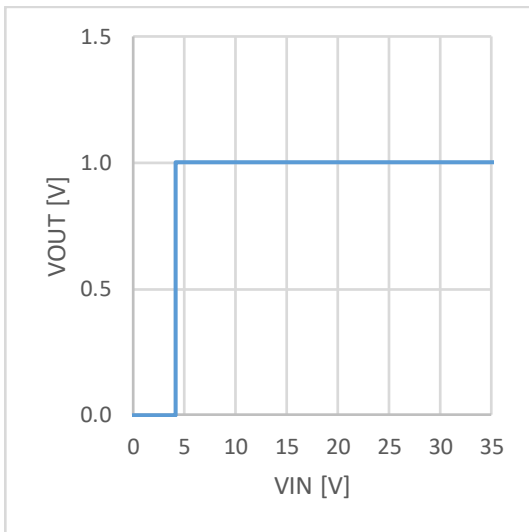

Figure 10. Line Regulation
(Io = 0mA)

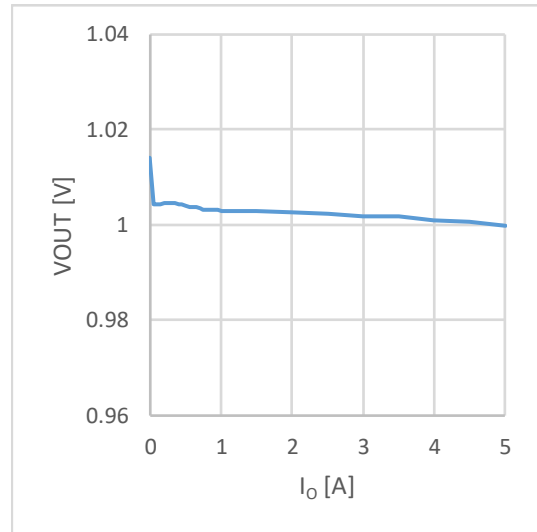

Figure 11. Load Regulation

Reference Application Curves – Cont'd

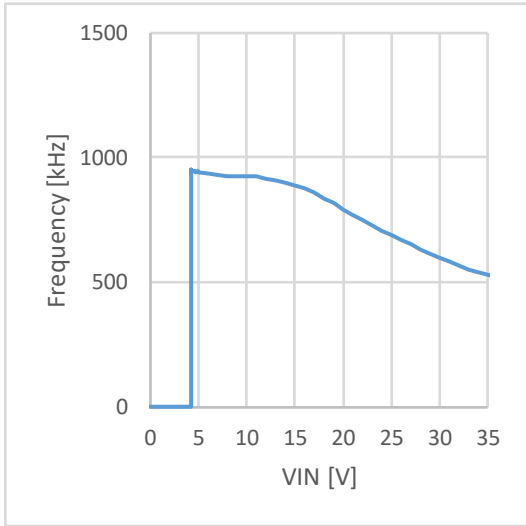

Figure 12. Switching Frequency vs VIN
($I_O = 1A$)

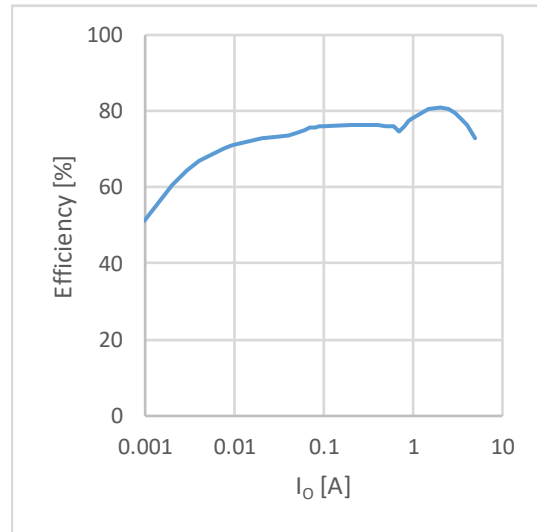

Figure 13. Efficiency vs Load Current

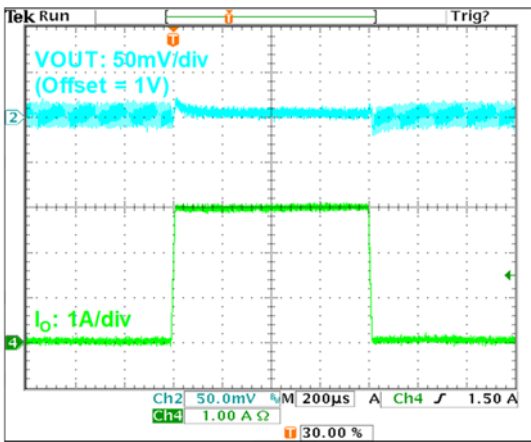

Figure 14. Load Response

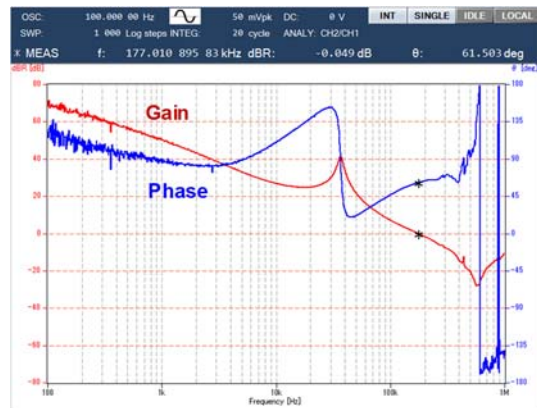

Figure 15. Frequency Response
($I_O = 5A$)

Reference Application Curves – Cont'd

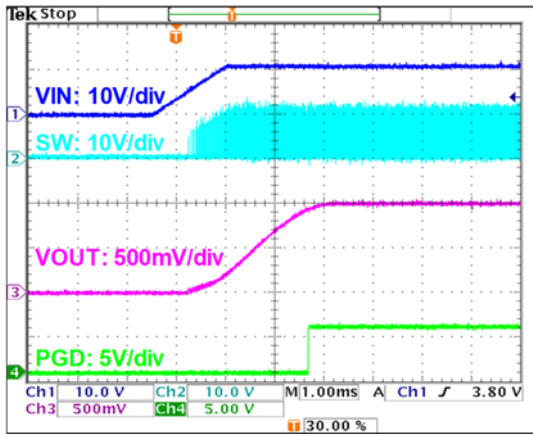

Figure 16. Start Up Waveform
($I_o = 1A$)

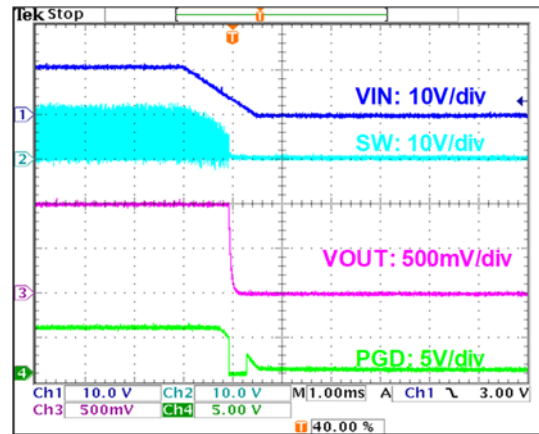

Figure 17. Shutdown Waveform
($I_o = 1A$)

Revision History

Date	Revision Number	Description
2020.12.17	001	Initial release

Notes

- 1) The information contained herein is subject to change without notice.
- 2) Before you use our Products, please contact our sales representative and verify the latest specifications :
- 3) Although ROHM is continuously working to improve product reliability and quality, semiconductors can break down and malfunction due to various factors.
Therefore, in order to prevent personal injury or fire arising from failure, please take safety measures such as complying with the derating characteristics, implementing redundant and fire prevention designs, and utilizing backups and fail-safe procedures. ROHM shall have no responsibility for any damages arising out of the use of our Products beyond the rating specified by ROHM.
- 4) Examples of application circuits, circuit constants and any other information contained herein are provided only to illustrate the standard usage and operations of the Products. The peripheral conditions must be taken into account when designing circuits for mass production.
- 5) The technical information specified herein is intended only to show the typical functions of and examples of application circuits for the Products. ROHM does not grant you, explicitly or implicitly, any license to use or exercise intellectual property or other rights held by ROHM or any other parties. ROHM shall have no responsibility whatsoever for any dispute arising out of the use of such technical information.
- 6) The Products specified in this document are not designed to be radiation tolerant.
- 7) For use of our Products in applications requiring a high degree of reliability (as exemplified below), please contact and consult with a ROHM representative : transportation equipment (i.e. cars, ships, trains), primary communication equipment, traffic lights, fire/crime prevention, safety equipment, medical systems, servers, solar cells, and power transmission systems.
- 8) Do not use our Products in applications requiring extremely high reliability, such as aerospace equipment, nuclear power control systems, and submarine repeaters.
- 9) ROHM shall have no responsibility for any damages or injury arising from non-compliance with the recommended usage conditions and specifications contained herein.
- 10) ROHM has used reasonable care to ensure the accuracy of the information contained in this document. However, ROHM does not warrants that such information is error-free, and ROHM shall have no responsibility for any damages arising from any inaccuracy or misprint of such information.
- 11) Please use the Products in accordance with any applicable environmental laws and regulations, such as the RoHS Directive. For more details, including RoHS compatibility, please contact a ROHM sales office. ROHM shall have no responsibility for any damages or losses resulting non-compliance with any applicable laws or regulations.
- 12) When providing our Products and technologies contained in this document to other countries, you must abide by the procedures and provisions stipulated in all applicable export laws and regulations, including without limitation the US Export Administration Regulations and the Foreign Exchange and Foreign Trade Act.
- 13) This document, in part or in whole, may not be reprinted or reproduced without prior consent of ROHM.



Thank you for your accessing to ROHM product informations.
More detail product informations and catalogs are available, please contact us.

ROHM Customer Support System

<https://www.rohm.com/contact/>