



BD9G500EFJ-EVK-001

User's Guide

<High Voltage Safety Precautions>

- ◇ Read all safety precautions before use

Please note that this document covers only the **BD9G500EFJ-LA** evaluation board (BD9G500EFJ-EVK-001) and its functions. For additional information, please refer to the datasheet.

To ensure safe operation, please carefully read all precautions before handling the evaluation board



Depending on the configuration of the board and voltages used,

Potentially lethal voltages may be generated.

Therefore, please make sure to read and observe all safety precautions described in the red box below.

Before Use

- [1] Verify that the parts/components are not damaged or missing (i.e. due to the drops).
- [2] Check that there are no conductive foreign objects on the board.
- [3] Be careful when performing soldering on the module and/or evaluation board to ensure that solder splash does not occur.
- [4] Check that there is no condensation or water droplets on the circuit board.

During Use

- [5] Be careful to not allow conductive objects to come into contact with the board.
- [6] **Brief accidental contact or even bringing your hand close to the board may result in discharge and lead to severe injury or death.**

Therefore, DO NOT touch the board with your bare hands or bring them too close to the board.

In addition, as mentioned above please exercise extreme caution when using conductive tools such as tweezers and screwdrivers.

- [7] If used under conditions beyond its rated voltage, it may cause defects such as short-circuit or, depending on the circumstances, explosion or other permanent damages.

After Use

- [8] Be sure to wear insulated gloves when handling is required during operation.
- [9] The ROHM Evaluation Board contains the circuits which store the high voltage. Since it stores the charges even after the connected power circuits are cut, please discharge the electricity after using it, and please deal with it after confirming such electric discharge.
- [10] Protect against electric shocks by wearing insulated gloves when handling.

This evaluation board is intended for use only in research and development facilities and should be handled **only by qualified personnel familiar with all safety and operating procedures.**

We recommend carrying out operation in a safe environment that includes the use of high voltage signage at all entrances, safety interlocks, and protective glasses.

Switching Regulator Series

1ch Buck Converter

BD9G500EFJ-LA EVK

BD9G500EFJ-EVK-001 (48V→5V, 5A)

Introduction

This user's guide describes the steps required to operate the EVK of BD9G500EFJ-LA. This document includes a description of peripheral components, operating instructions, and reference data.

Description

BD9G500EFJ-EVK-001 uses BD9G500EFJ-LA to output 5V from a 48V input voltage. The input voltage of the BD9G500EFJ-LA is from 7V to 76V and the output voltage is configurable from 1V to $0.97 \times V_{IN}$ V with external resistors. The operating frequency is configurable between 100 kHz and 650 kHz with an external resistor connected to RT pin. This is a current mode control DC/DC converter that provides fast transient response performance and simple phase compensation setup. Built-in functions include variable soft start function which prevents inrush current at startup, UVLO (Under Voltage Lock Out), TSD (Thermal Shutdown Detection), OVP (Over Voltage Protection), OCP (Over Current Protection) and OVDIS (Over Voltage Discharge).

Application

- Industrial Equipment
- Power Supply for FA
- Communication Equipment
- Battery Management System (BMS)

EVK Operating Limits

Parameter	Min	Typ	Max	Units	Conditions
Input Voltage	7.0	-	48.0	V	
Output Voltage		5.0		V	
Maximum Output Current			5.0	A	
Switching Frequency		200		kHz	
Maximum Efficiency		81		%	$I_O = 2.5A$
UVLO Threshold Voltage		6.4		V	VIN sweep down
UVLO Hysteresis Voltage		200		mV	

EVK Overview



Figure 1. BD9G500EFJ-EVK-001(Top View)

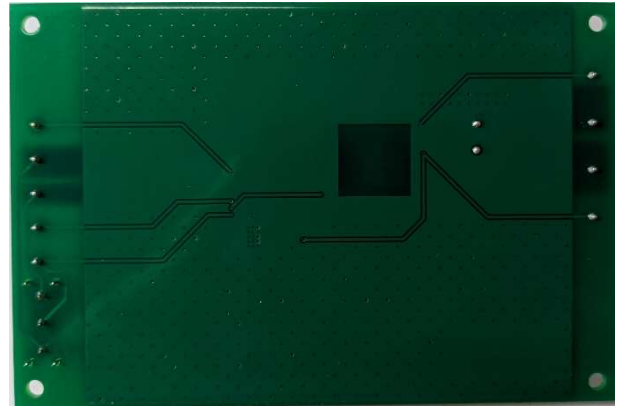

Figure 2. BD9G500EFJ-EVK-001(Bottom View)

EVK Schematic

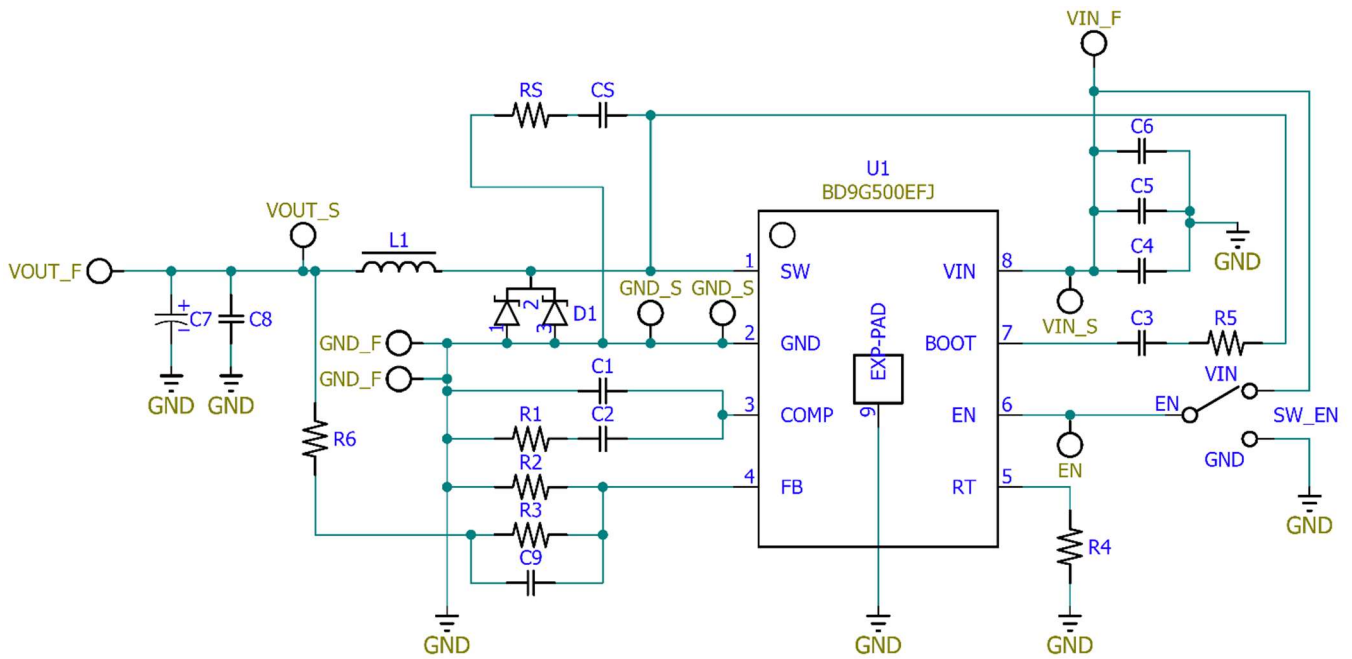

Figure 3. BD9G500EFJ-EVK-001 Schematic

Operating Procedure

1. Turn off the DC power supply power switch and connect the power supply's GND terminal to the GND_F pin of the EVK.
2. Connect the positive terminal of the DC power supply to the VIN_F pin of the EVK.
3. Connect the load across the VOUT_F pin and the GND_F pin of the EVK. In the case of an electronic load, turn the load off.
4. Connect the voltmeter's positive terminal to the EVK's VOUT_S pin and the GND terminal to the EVK's GND_S pin.
5. Tilt the switch of SW_EN to the VIN side.
6. Turn on the DC power supply. Make sure that the voltmeter reading is 5V.
7. Turn on the electronic load.

(Caution) This EVK does not support hot plug. Do not perform hot plug test.

Operating State Settings

Select the status of BD9G500EFJ-LA as shown in Table 1 according to the EN pin voltage.

Table 1. EN Pin Settings

EN Pin Voltage	State
HIGH (≥ 2.5 V)	Enable
LOW (≤ 0.4 V)	Shutdown

Parts List

Table 2. Parts List

Count	Parts No.	Type	Value	Description	Manufacturer Part Number	Manufacturer	Configuration mm (inch)
1	U1	IC	-	Single BUCK Converter	BD9G500EFJ-LA	ROHM	4.9 mm x 6.0 mm
1	L1	Inductor	33 μ H	5.5A, \pm 20%	7443551331	WE	13 mm x 13 mm
1	D1	Schottky Barrier Diode	-	$V_R=100V$ $I_O=10A$	RB088BM100	ROHM	6.6 mm x 10 mm
0	C1	Ceramic Capacitor	No mount	N/A	N/A	N/A	1005 (0402)
1	C2	Ceramic Capacitor	6800pF	50V, COG, \pm 5%	GRM1555C1H682JE01	Murata	1005 (0402)
1	C3	Ceramic Capacitor	1 μ F	10V, X5R, \pm 20%	GRM153R61A105ME95	Murata	1005 (0402)
1	C4	Ceramic Capacitor	10 μ F	100V, X7S, \pm 10%	GRM32EC72A106KE05	Murata	3225 (1210)
1	C5	Ceramic Capacitor	10 μ F	100V, X7S, \pm 10%	GRM32EC72A106KE05	Murata	3225 (1210)
1	C6	Ceramic Capacitor	1 μ F	100V, X7S, \pm 10%	GRM21BC72A105KE01	Murata	2012 (0805)
1	C7	Aluminum Electrolytic Capacitor	220 μ F	50V, \pm 20%	UBT1H221MPD8	Nichicon	Φ 10 mm
1	C8	Ceramic Capacitor	47 μ F	10V, X6S, \pm 10%	GRM32EC81A476KE19	Murata	3225 (1210)
0	C9	Ceramic Capacitor	No mount	N/A	N/A	N/A	1005 (0402)
0	CS	Ceramic Capacitor	No mount	N/A	N/A	N/A	1005 (0402)
1	R1	Resistor	62k Ω	50V, \pm 1%, 1/16W	MCR01MZPF6202	ROHM	1005 (0402)
1	R2	Resistor	0.75k Ω	50V, \pm 1%, 1/16W	MCR01MZPF7500	ROHM	1005 (0402)
1	R3	Resistor	3k Ω	50V, \pm 1%, 1/16W	MCR01MZPF3001	ROHM	1005 (0402)
1	R4	Resistor	47k Ω	50V, \pm 1%, 1/16W	MCR01MZPF4702	ROHM	1005 (0402)
1	R5	Resistor	0 Ω	Jumper	MCR01MZPJ000	ROHM	1005 (0402)
1	R6	Resistor	0 Ω	Jumper	MCR01MZPJ000	ROHM	1005 (0402)
0	RS	Resistor	No mount	N/A	N/A	N/A	1005 (0402)
1	SW_EN	Miniature Toggle Switch	-	-	BT1E-2M4-Z	NIDEC COPAL	7.6 mm x 12.7 mm
9	VIN_F, VIN_S, VOUT_F, VOUT_S, GND_F, GND_S, EN	Test Pin	-	-	ST-2-2	MAC8	Φ 2.5 mm

EVK PCB Layout

EVK PCB Information

Number of Layers	Material	Board Size	Copper Thickness
4	FR-4	114.3mm x 76.2mm x 1.6mmt	2oz (70 μ m) *Top, Bottom Layer 1oz (35 μ m) *Middle Layers

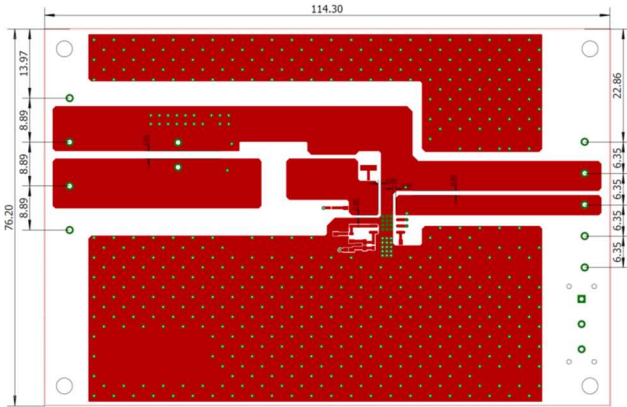

Figure 4. Top Layer Layout
(Top View)

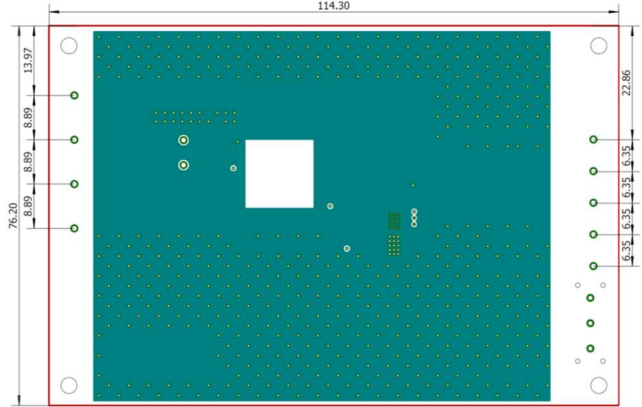

Figure 5. Middle1 Layer Layout
(Top View)

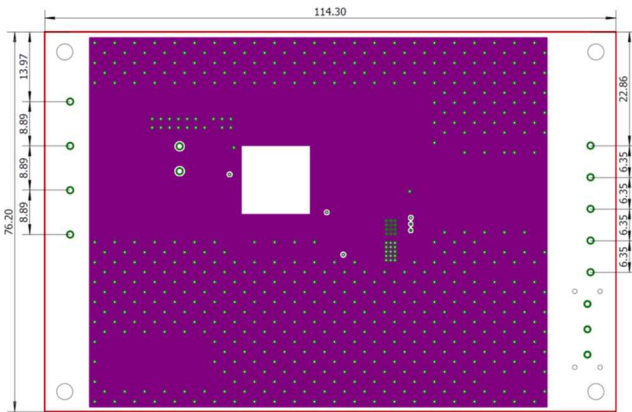

Figure 6. Middle2 Layer Layout
(Top View)

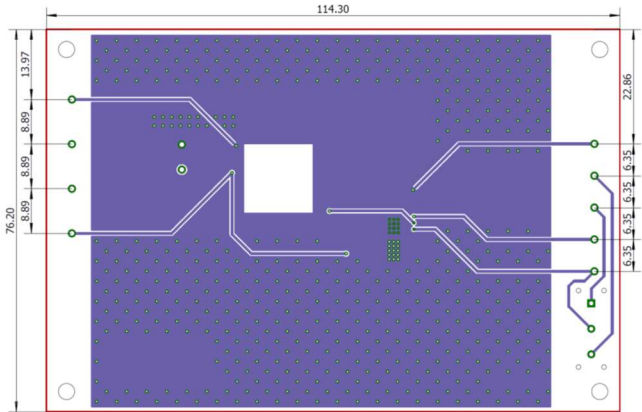

Figure 7. Bottom Layer Layout
(Top View)

Reference Application Curves

Ta = 25°C, VIN = 48V, EN = VIN, unless otherwise specified

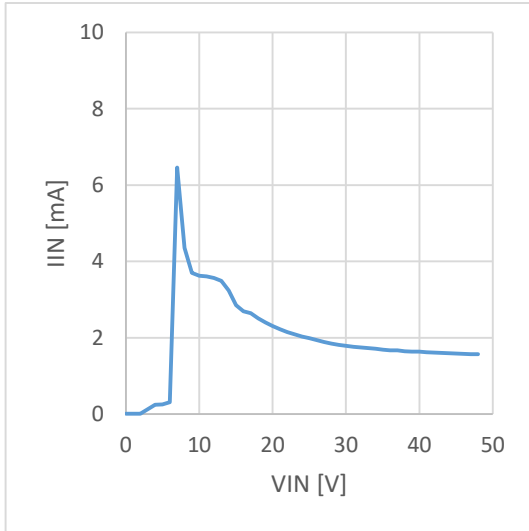

Figure 8. Current Consumption vs VIN
(Io = 0mA)

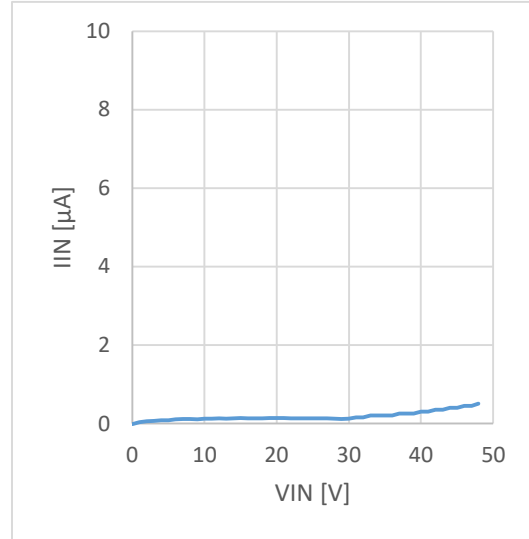

Figure 9. Shutdown Current vs VIN
(EN=GND)

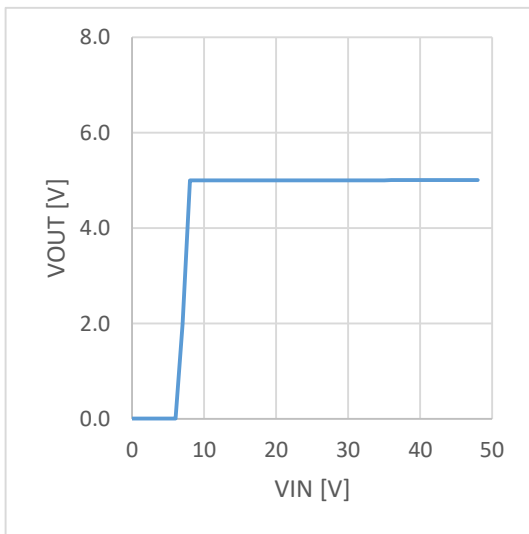

Figure 10. Line Regulation
(Io = 0mA)

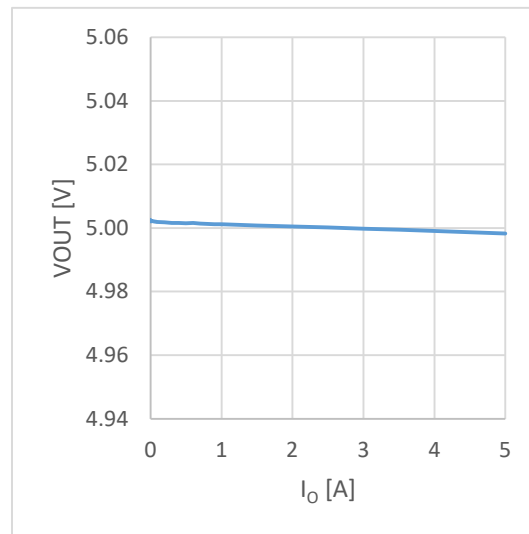

Figure 11. Load Regulation

Reference Application Curves – Cont'd

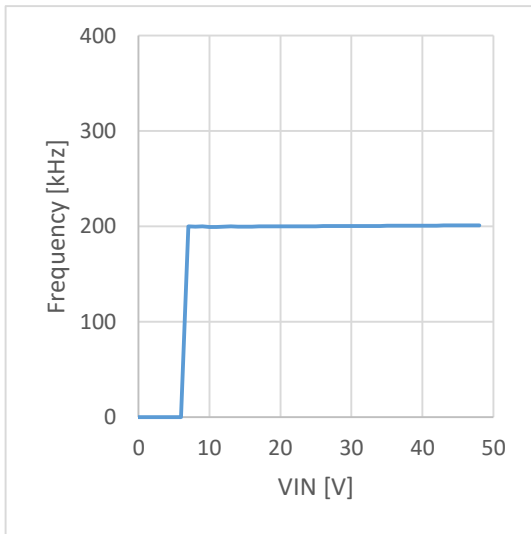

Figure 12. Switching Frequency vs VIN
($I_O = 1A$)

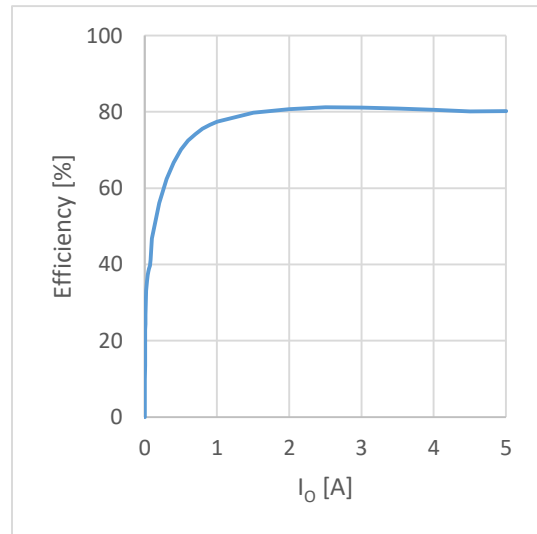

Figure 13. Efficiency vs Load Current

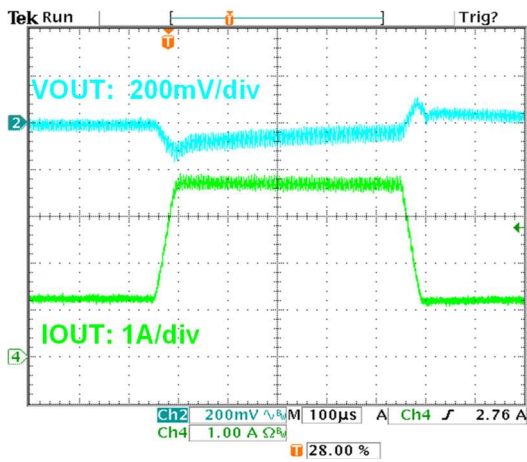

Figure 14. Load Response

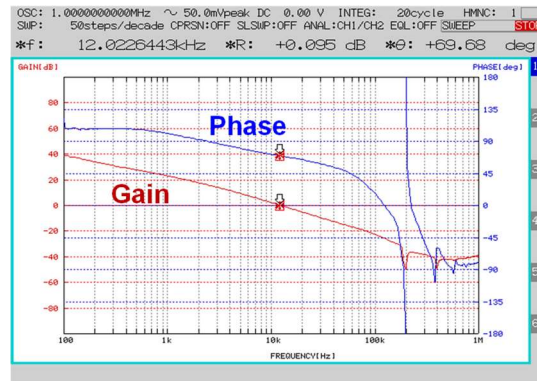

Figure 15. Frequency Response
($I_O = 5A$)

Reference Application Curves – Cont'd

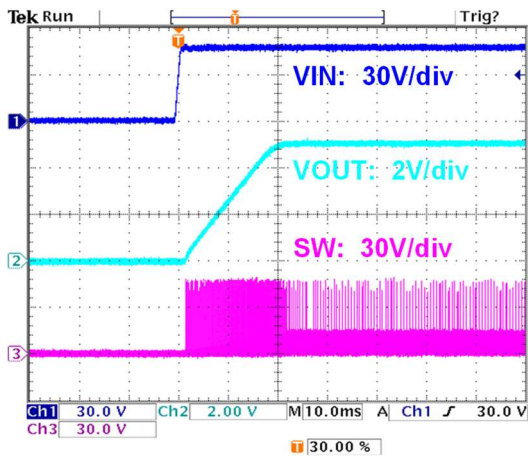

Figure 16. Start Up Waveform
($I_o = 0A$)

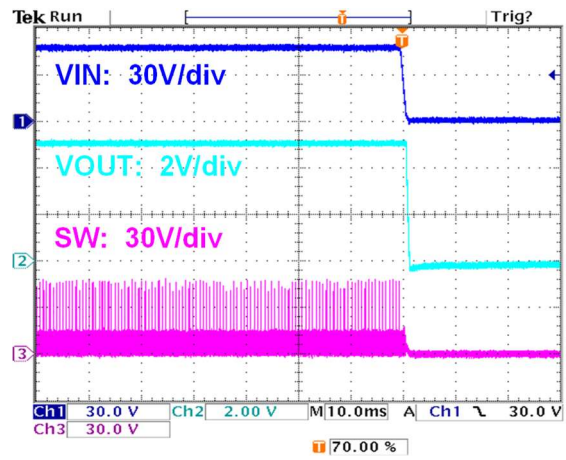

Figure 17. Shutdown Waveform
($I_o = 0A$)

Revision History

Date	Revision Number	Description
2021. 3. 3	001	Initial release

Notes

- 1) The information contained herein is subject to change without notice.
- 2) Before you use our Products, please contact our sales representative and verify the latest specifications :
- 3) Although ROHM is continuously working to improve product reliability and quality, semiconductors can break down and malfunction due to various factors.
Therefore, in order to prevent personal injury or fire arising from failure, please take safety measures such as complying with the derating characteristics, implementing redundant and fire prevention designs, and utilizing backups and fail-safe procedures. ROHM shall have no responsibility for any damages arising out of the use of our Products beyond the rating specified by ROHM.
- 4) Examples of application circuits, circuit constants and any other information contained herein are provided only to illustrate the standard usage and operations of the Products. The peripheral conditions must be taken into account when designing circuits for mass production.
- 5) The technical information specified herein is intended only to show the typical functions of and examples of application circuits for the Products. ROHM does not grant you, explicitly or implicitly, any license to use or exercise intellectual property or other rights held by ROHM or any other parties. ROHM shall have no responsibility whatsoever for any dispute arising out of the use of such technical information.
- 6) The Products specified in this document are not designed to be radiation tolerant.
- 7) For use of our Products in applications requiring a high degree of reliability (as exemplified below), please contact and consult with a ROHM representative : transportation equipment (i.e. cars, ships, trains), primary communication equipment, traffic lights, fire/crime prevention, safety equipment, medical systems, servers, solar cells, and power transmission systems.
- 8) Do not use our Products in applications requiring extremely high reliability, such as aerospace equipment, nuclear power control systems, and submarine repeaters.
- 9) ROHM shall have no responsibility for any damages or injury arising from non-compliance with the recommended usage conditions and specifications contained herein.
- 10) ROHM has used reasonable care to ensure the accuracy of the information contained in this document. However, ROHM does not warrants that such information is error-free, and ROHM shall have no responsibility for any damages arising from any inaccuracy or misprint of such information.
- 11) Please use the Products in accordance with any applicable environmental laws and regulations, such as the RoHS Directive. For more details, including RoHS compatibility, please contact a ROHM sales office. ROHM shall have no responsibility for any damages or losses resulting non-compliance with any applicable laws or regulations.
- 12) When providing our Products and technologies contained in this document to other countries, you must abide by the procedures and provisions stipulated in all applicable export laws and regulations, including without limitation the US Export Administration Regulations and the Foreign Exchange and Foreign Trade Act.
- 13) This document, in part or in whole, may not be reprinted or reproduced without prior consent of ROHM.



Thank you for your accessing to ROHM product informations.
More detail product informations and catalogs are available, please contact us.

ROHM Customer Support System

<https://www.rohm.com/contact/>

Mouser Electronics

Authorized Distributor

Click to View Pricing, Inventory, Delivery & Lifecycle Information:

[ROHM Semiconductor:](#)

[BD9G500EFJ-EVK-001](#)