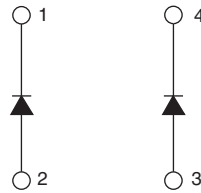

## Insulated Ultrafast Rectifier Module, 60 A

**SOT-227**
**FEATURES**

- Two fully independent diodes
- Ceramic fully insulated package ( $V_{ISOL} = 2500 V_{AC}$ )
- Ultrafast reverse recovery
- Ultrasoft reverse recovery current shape
- Low forward voltage
- Optimized for power conversion: welding and industrial SMPS applications
- Industry standard outline
- Plug-in compatible with other SOT-227 packages
- Easy to assemble
- Direct mounting to heatsink
- Totally lead (Pb)-free
- Designed and qualified for industrial level

**RoHS**  
COMPLIANT

**DESCRIPTION**

The UFB60FA60P insulated modules integrate two state of the art Vishay's ultrafast recovery rectifiers in the compact, industry standard SOT-227 package. The planar structure of the diodes, and the platinum doping life time control, provide an ultrasoft recovery current shape, together with the best overall performance, ruggedness, and reliability characteristics.

These devices are thus intended for high frequency applications in which the switching energy is designed not to be a predominant portion of the total energy, such as in the output rectification stage of welding machines, SMPS, and dc-to-dc converters. Their extremely optimized stored charge and low recovery current reduce both over dissipation in the switching elements (and snubbers) and EMI/RFI.

**PRODUCT SUMMARY**

$V_R$	600 V
$I_{F(AV)}$ per module at $T_C = 107^\circ C$	60 A
$t_{rr}$	79 ns

**ABSOLUTE MAXIMUM RATINGS**

PARAMETER	SYMBOL	TEST CONDITIONS	MAX.	UNITS
Cathode to anode voltage	$V_R$		600	V
Continuous forward current per diode	$I_F$	$T_C = 85^\circ C$	44	A
Single pulse forward current per diode	$I_{FSM}$	$T_C = 25^\circ C$	280	
Maximum power dissipation per module	$P_D$	$T_C = 85^\circ C$	120	W
RMS isolation voltage	$V_{ISOL}$	Any terminal to case, $t = 1 \text{ min}$	2500	V
Operating junction and storage temperatures	$T_J, T_{Stg}$		- 55 to 175	$^\circ C$



<b>ELECTRICAL SPECIFICATIONS</b> ( $T_J = 25\text{ }^\circ\text{C}$ unless otherwise specified)							
PARAMETER	SYMBOL	TEST CONDITIONS	MIN.	TYP.	MAX.	UNITS	
Cathode to anode breakdown voltage	$V_{BR}$	$I_R = 100\text{ }\mu\text{A}$	600	-	-	V	
Forward voltage	$V_{FM}$	$I_F = 30\text{ A}$	-	1.32	1.69		
		$I_F = 60\text{ A}$	-	1.52	1.9		
		$I_F = 30\text{ A}$	$T_J = 125\text{ }^\circ\text{C}$	-	1.14		1.39
		$I_F = 60\text{ A}$		-	1.38		1.66
Reverse leakage current	$I_{RM}$	$V_R = V_R\text{ rated}$	-	0.1	100	$\mu\text{A}$	
		$T_J = 175\text{ }^\circ\text{C}$ , $V_R = V_R\text{ rated}$	-	0.2	1.0	$\text{mA}$	
Junction capacitance	$C_T$	$V_R = 600\text{ V}$	-	50	-	$\text{pF}$	

<b>DYNAMIC RECOVERY CHARACTERISTICS</b> ( $T_J = 25\text{ }^\circ\text{C}$ unless otherwise specified)							
PARAMETER	SYMBOL	TEST CONDITIONS	MIN.	TYP.	MAX.	UNITS	
Reverse recovery time	$t_{rr}$	$T_J = 25\text{ }^\circ\text{C}$	-	79	118	ns	
		$T_J = 125\text{ }^\circ\text{C}$	-	155	209		
Peak recovery current	$I_{RRM}$	$T_J = 25\text{ }^\circ\text{C}$	$I_F = 30\text{ A}$ $di_F/dt = 200\text{ A}/\mu\text{s}$ $V_R = 200\text{ V}$	-	6	10	A
		$T_J = 125\text{ }^\circ\text{C}$		-	14	20	
Reverse recovery charge	$Q_{rr}$	$T_J = 25\text{ }^\circ\text{C}$		-	234	590	nC
		$T_J = 125\text{ }^\circ\text{C}$		-	1085	2090	

<b>THERMAL - MECHANICAL SPECIFICATIONS</b>						
PARAMETER	SYMBOL	TEST CONDITIONS	MIN.	TYP.	MAX.	UNITS
Junction to case, single leg conducting	$R_{thJC}$		-	-	1.5	$^\circ\text{C}/\text{W}$
Junction to case, both leg conducting			-	-	0.75	
Case to heatsink	$R_{thCS}$	Flat, greased surface	-	0.05	-	
Weight			-	30	-	g
Mounting torque			-	1.3	-	$\text{N} \cdot \text{m}$

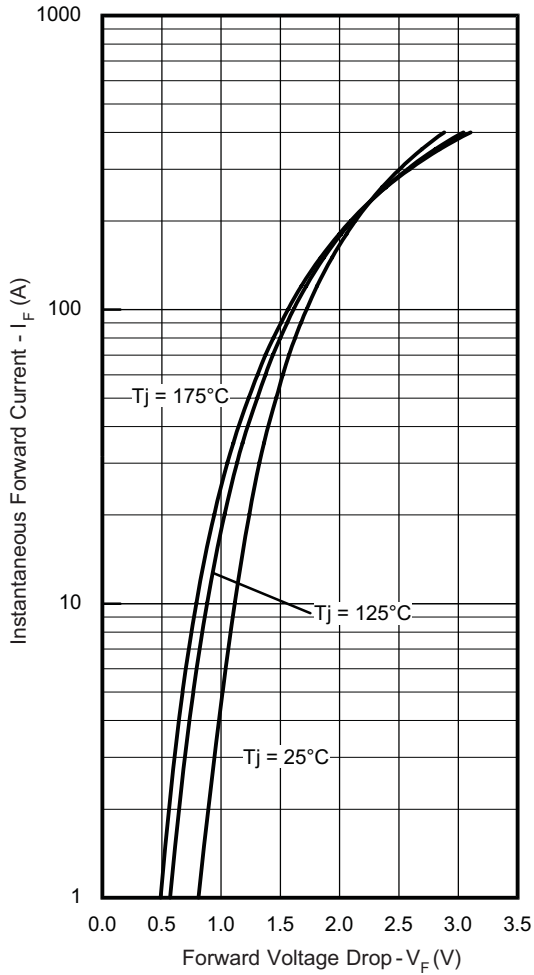

Fig. 1 - Typical Forward Voltage Drop Characteristics (Per Diode)

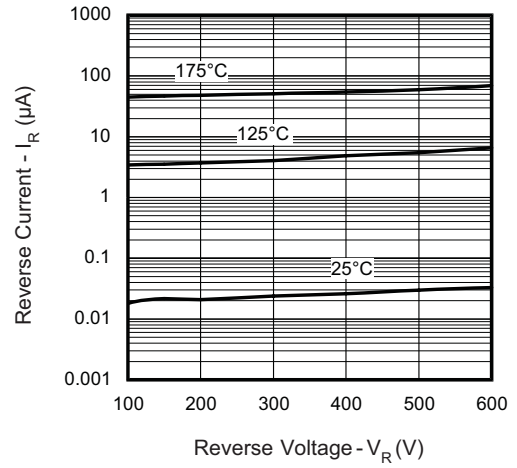

Fig. 2 - Typical Values of Reverse Current vs. Reverse Voltage

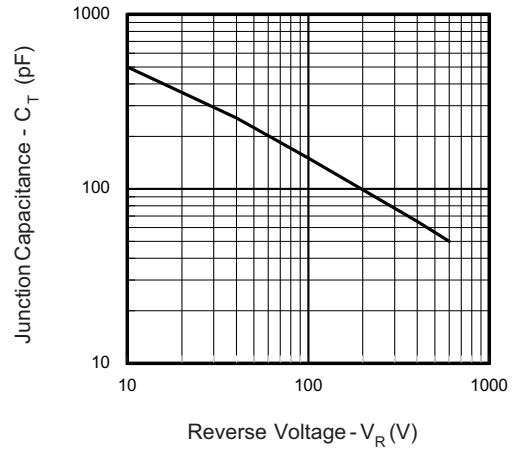

Fig. 3 - Typical Junction Capacitance vs. Reverse Voltage

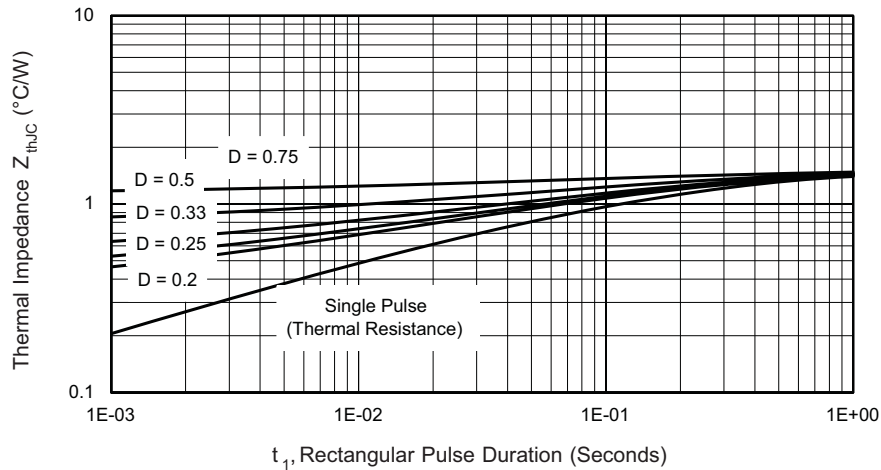

Fig. 4 - Maximum Thermal Impedance  $Z_{thJC}$  Characteristics (Per Diode)

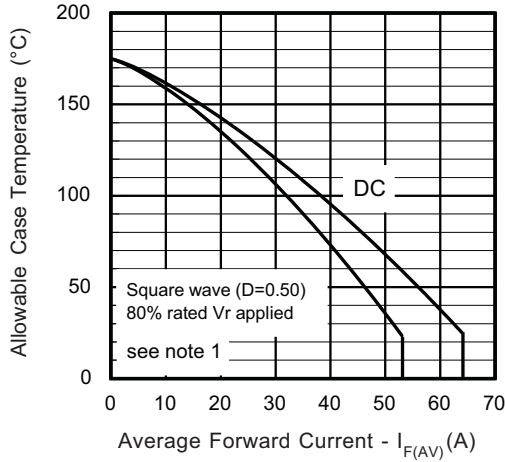

Fig. 5 - Maximum Allowable Case Temperature vs. Average Forward Current (Per Leg)

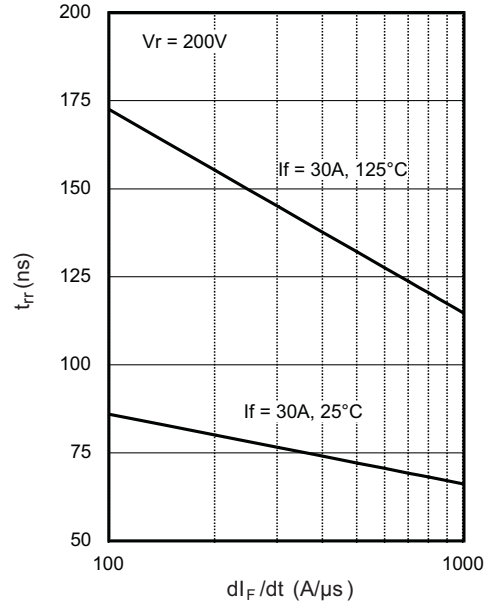

Fig. 7 - Typical Reverse Recovery Time vs.  $di_F/dt$

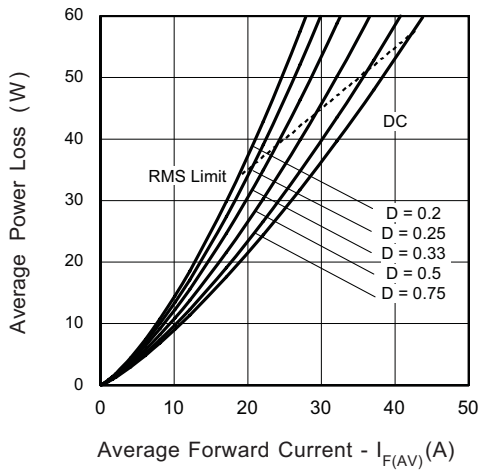

Fig. 6 - Forward Power Loss Characteristics (Per Leg)

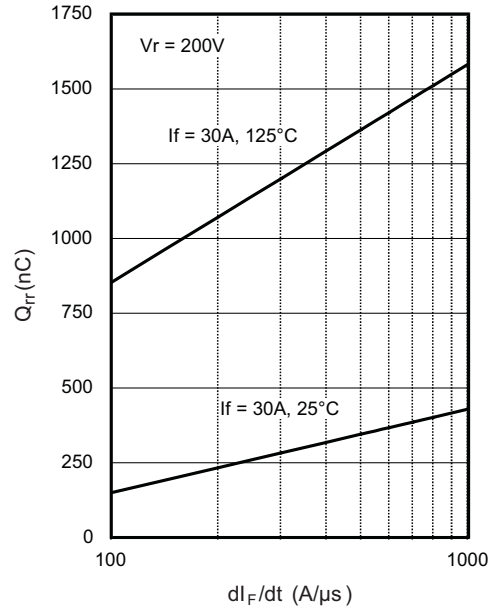

Fig. 8 - Typical Stored Charge vs.  $di_F/dt$

**Note**

(1) Formula used:  $T_C = T_J - (Pd + Pd_{REV}) \times R_{thJC}$ ;  
 $Pd$  = Forward power loss =  $I_{F(AV)} \times V_{FM}$  at  $(I_{F(AV)}/D)$  (see fig. 6);  
 $Pd_{REV}$  = Inverse power loss =  $V_{R1} \times I_R (1 - D)$ ;  $I_R$  at  $V_{R1} = 80\%$  rated  $V_R$

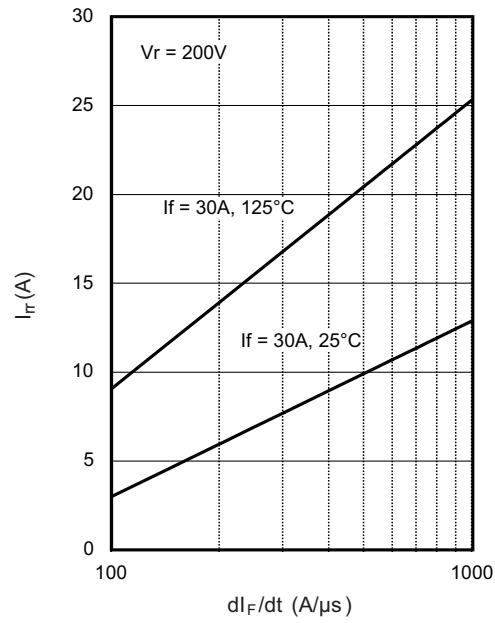
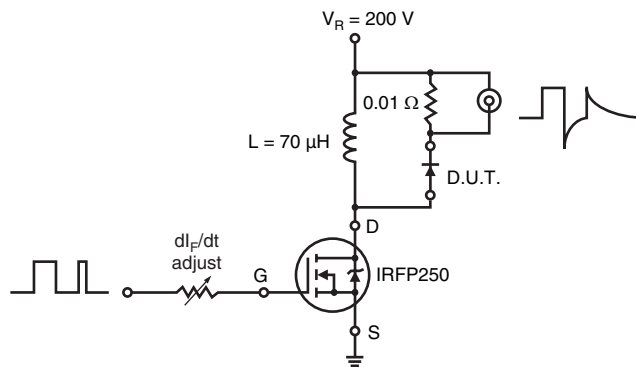

 Fig. 9 - Typical Stored Current vs.  $di_F/dt$ 

Fig. 10 - Reverse Recovery Parameter Test Circuit

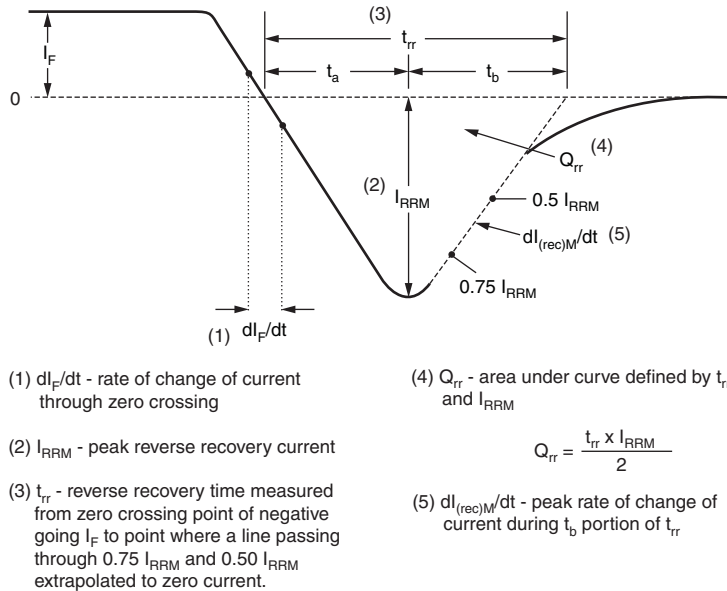

Fig. 11 - Reverse Recovery Waveform and Definitions

## ORDERING INFORMATION TABLE

Device code	<b>UF</b>	<b>B</b>	<b>60</b>	<b>F</b>	<b>A</b>	<b>60</b>	<b>P</b>
	①	②	③	④	⑤	⑥	⑦
	<b>1</b>	-	Ultrafast rectifier				
	<b>2</b>	-	Ultrafast Pt diffused				
	<b>3</b>	-	Current rating (60 = 60 A)				
	<b>4</b>	-	Circuit configuration (2 separate diodes, parallel pin-out)				
	<b>5</b>	-	Package indicator (SOT-227 standard isolated base)				
	<b>6</b>	-	Voltage rating (60 = 600 V)				
	<b>7</b>	-	P = Lead (Pb)-free				

LINKS TO RELATED DOCUMENTS	
Dimensions	<a href="http://www.vishay.com/doc?95036">http://www.vishay.com/doc?95036</a>
Packaging information	<a href="http://www.vishay.com/doc?95037">http://www.vishay.com/doc?95037</a>



## Disclaimer

All product specifications and data are subject to change without notice.

Vishay Intertechnology, Inc., its affiliates, agents, and employees, and all persons acting on its or their behalf (collectively, "Vishay"), disclaim any and all liability for any errors, inaccuracies or incompleteness contained herein or in any other disclosure relating to any product.

Vishay disclaims any and all liability arising out of the use or application of any product described herein or of any information provided herein to the maximum extent permitted by law. The product specifications do not expand or otherwise modify Vishay's terms and conditions of purchase, including but not limited to the warranty expressed therein, which apply to these products.

No license, express or implied, by estoppel or otherwise, to any intellectual property rights is granted by this document or by any conduct of Vishay.

The products shown herein are not designed for use in medical, life-saving, or life-sustaining applications unless otherwise expressly indicated. Customers using or selling Vishay products not expressly indicated for use in such applications do so entirely at their own risk and agree to fully indemnify Vishay for any damages arising or resulting from such use or sale. Please contact authorized Vishay personnel to obtain written terms and conditions regarding products designed for such applications.

Product names and markings noted herein may be trademarks of their respective owners.

# Mouser Electronics

Authorized Distributor

Click to View Pricing, Inventory, Delivery & Lifecycle Information:

[Vishay:](#)

[UFB60FA60P](#)