

Recommended PCB Layout  
Tolerance:±0.1(Top view)

SPECIFICATIONS:

- ELECTRICAL CHARACTERISTICS:
  - RATING:1.8A(PIN1/5), 0.5A(PIN2/3/4)
  - CONTACT RESISTANCE:30mΩ MAX.7IN(MAL)
  - DIELECTRIC WITHSTANDING VOLTAGE:300V AC FOR ONE MINUTE
  - INSULATION RESISTANCE: 100M Ω MIN. MEASURED BY 500 VDC
- MECHANICAL CHARACTERISTICS:
  - INSERTION FORCE:3.6 KGF (MAX)
  - WITHDRAWAL FORCE:0.8 KCF(Reference)
- DURABILITY:10,000 CYCLES
- WATER PROOFNESS:THIS PRODUCT IS BASED ON IPX7(1m,30min)
- PLUG INTERFACE DIMENSIONS COMFORM TO USB2.0 SPEC.
- OVAL RING
  - The amount of low molecular siloxanes(D3~010)is less than 200ppm
  - Hardness of silicone rubber:70°
- FOR REFLOW SOLDERING LEAD-FREE PROCESS.
- PACKAGING:TAPE & REEL.

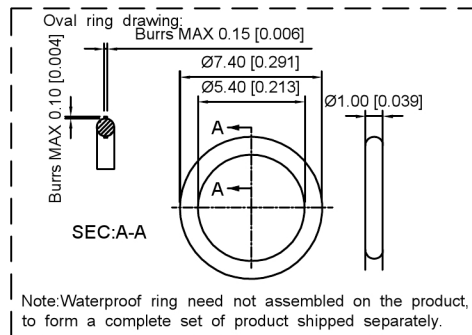
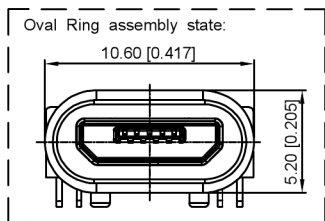
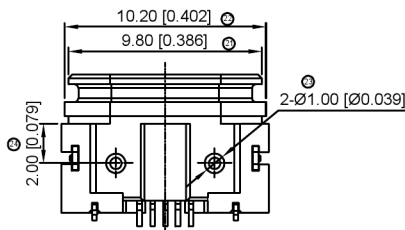
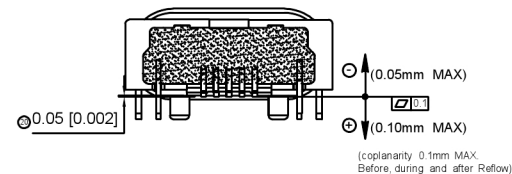
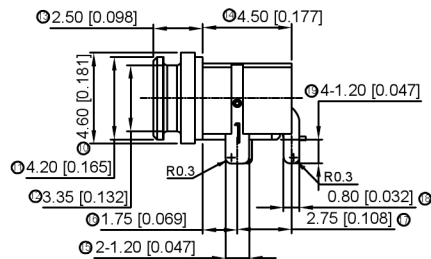
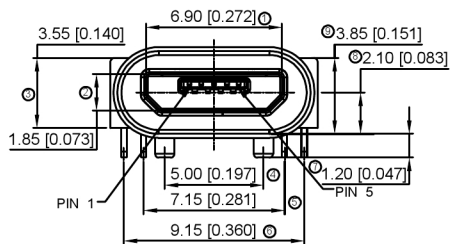

Note:Waterproof ring need not assembled on the product, to form a complete set of product shipped separately.

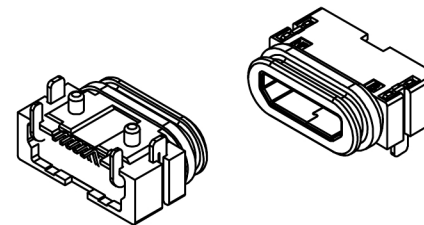

ITEM	PAPT NAME	QTY	MATERIAL	FINISHING
④	Contact	5	C18140H T=0.20	
③	Shell	1	SUS304 T=0.25	Nickel
②	Terminal	2	C2680 T=0.3	
①	Housing	1	HI-TEMP.PLASIC UL 94V-0	BLACK

UNLESS OTHERWISE SPECIFIED, TOLERANCE ON DECIMAL:±0.3

广东星坤科技股份有限公司

ΔX		日期
ΔX		日期
ΔX		日期
MARK		DESCRIPTION

文件工程章

REVISIONS	DATE	REVISED	APPROVED	UNSPECIFIED TOLERANCES

www.helloxkb.com www.helloxkb.cn www.xk-dg.cn



XKB INDUSTRIAL PRECISION CO.,LIMITED

DSND	SCALE: N/A	MODEL TYPE: MICRO USB
DWN	VIEW:	PART NO.:
CHKD	UNIT: mm/in	DWG NO.:
APPD	SIZE: A4	U-E-M7SS-Y-1
	WEIGHT	SHEET
		REVISIOI
	1/1	A0